

Electronics World

JANUARY, 1970
60 CENTS

TELEVISION: 20 YEARS FROM NOW
EQUALIZING HI-FI SYSTEMS TO ROOM ACOUSTICS
TV-FM LEAD-IN: WHAT KIND TO USE?
TAMING RADAR WEATHER CLUTTER

Directory of
1970 COLOR-TV SETS





Can a tough, little \$49.20 microphone make the big time? (A success story.)



Ⓔ A good little microphone, the E-V 635A. But just how good? After all, it was intended to replace the "workhorse" Model 635... a dynamic microphone that had earned its title under fire in studios and on remotes all around the world.

So when we introduced the 635A we put it to a critical test. A major recording studio was loaned a dozen 635A's and asked to test them. The engineers weren't told the price, but they got the idea that it was somewhere near \$300.00.

They were so delighted with the sound

that they cut several big band recordings with nothing but 635A's. "Best \$300.00 microphone we've got." Then we told them the price. They were shocked. \$49.20? They couldn't believe their ears.

Meanwhile, 635A's were beginning to appear in force on music and variety shows on every TV network. Mostly hand held. Something to do with ruggedness and good balance... but mostly because of the sound. Especially during ultra-close miking.

The rest is history. Radio and TV newsmen quickly adopted the 635A as

their new "workhorse". After all, news only happens once, and the 635A was their best insurance against bad sound.

To most professional sound engineers, the E-V 635A is already an old friend, although it's only been around since 1965.

At the price, they can afford to use it almost everywhere. And they do. (We told you it was a success story.)

ELECTRO-VOICE, INC., Dept. 101 N
629 Cecil Street, Buchanan, Michigan 49107

MODEL 635A Omnidirectional dynamic. Response 60-13,000 Hz. Output -65db. Balanced low impedance. Includes Model 310A stand clamp and lavalier neck cord. Fawn beige Micomatte finish.

FOR INFORMATION ON E-V PRODUCTS:

Microphones
CIRCLE NO. 111 ON READER SERVICE CARD

PA Speakers/Accessories
CIRCLE NO. 112 ON READER SERVICE CARD

Musician's speakers/microphones
CIRCLE NO. 113 ON READER SERVICE CARD

High Fidelity speakers/electronics
CIRCLE NO. 114 ON READER SERVICE CARD

Electro-Voice®

A SUBSIDIARY OF GILTON INDUSTRIES, INC.

Grantham School of Engineering EW-1-70

1505 N. Western Ave., Hollywood, Calif. 90027

Gentlemen:

Please mail me your free Bulletin which explains how the Grantham home-study educational program can prepare me for my Associate in Science Degree in Electronics Engineering.

Name _____ Age _____

Address _____

City _____ State _____ Zip _____



Grantham School of Engineering

has conferred on

John Doe

the degree of

Associate in Science in Electronics Engineering

with all the rights and privileges thereunto appertaining. In witness thereof this diploma duly signed has been issued by the School Administration upon recommendation of the faculty at the School on this



first day of October, 1968
D. J. Grantham President
E. J. Lutter Acting Dean



Grantham School of Engineering

has conferred on

John Doe

the degree of

Bachelor of Science in Electronics Engineering

with all the rights and privileges thereunto appertaining. In witness thereof this diploma duly signed has been issued by the School Administration upon recommendation of the



faculty at the school on this *sixth day of December, 1968*

D. J. Grantham President
H. A. Lenny Dean

Grantham School of Engineering

Home Study Division

1505 N. Western Ave.

Hollywood, Calif. 90027

Telephone:

(213) 469-7878



CIRCLE NO. 133 ON READER SERVICE CARD

January, 1970

Three Big Steps
to Success...
in

ELECTRONICS ENGINEERING

There they are — three big steps that lead electronics technicians to *greater success* — three deliberate steps to *greater recognition* and *more income*. Your future is shaped by the moves you make — by the steps you take. Begin now with Step #1.

STEP #1 is a simple request for full information on the Grantham Electronics Degree Program. You take this first step by filling out and mailing the coupon. Then, we *mail* our catalog to you; we do not send a salesman.

STEP #2 is earning your Associate in Science Degree in Electronics Engineering (the ASEE). If you have completed at least one year of fulltime experience as a bona fide electronics technician, you may earn your ASEE Degree almost entirely by correspondence — including a minimum resident attendance of only two weeks.

STEP #3 is earning your Bachelor's Degree in Electronics Engineering. Upon earning your ASEE Degree you may have reached your objective, or you may wish to continue and earn your BSEE Degree. The Grantham BSEE Degree program is offered in evening classes in Hollywood, and is designed especially for employed engineering technicians who hold the ASEE Degree.

Accreditation, and G.I. Bill Approval

The Home Study Division of Grantham School of Engineering is accredited by the Accrediting Commission of the National Home Study Council. Both the Home Study Division and the Resident Division are approved under the G.I. Bill, and both divisions are legally authorized to grant academic degrees.

The Home-Study Method

Grantham School of Engineering is a *specialized*, college-level, educational institution—established in 1951—which teaches engineering by the so-called “new approach.” This is the method (often referred to by names such as “independent study”) that has recently created great interest among college educators. Actually, this “new approach” is not new at all. Grantham and many other good schools have been using it for years, under such names as “home study” and “correspondence instruction.”

Now that the method has become “respectable” and is being used by reputable colleges to lead to bachelor's degrees, Grantham can offer electronics technicians the opportunity to study for an accredited ASEE Degree mostly by correspondence. As a technician, you already know the “hardware” side of electronics, and you can upgrade from technician to engineer while you continue your employment as a technician. Get complete details. Mail the coupon for our free bulletin.



The sensibly priced tape cassette ...from MALLORY.

Just what you've been waiting for. The new Mallory DURATAPE® Cassette.

You get the quality and performance of expensive tape cassettes at a nice, lots-less price. But not the poor performance or the problems of the special-discount cheapies.

And since they're from Mallory — a company long known for quality electronic products—you can expect high fidelity, smooth operation, and long reliability. And get it . . . every time!

They'll fit any cassette recorder, player, cassette-radio. Even the new cassette changers. And you pick the recording time: 30, 60, 90, 120 minutes.

Our DURATAPE® Cassettes are tough but we put them in unbreakable, easy-to-stack containers just for extra protection. Like in the rain or through the mail.

And we make a head cleaner that's perfect for Cassette Recorders, too.

You'll find this great new thing in sound wherever Mallory products are sold.

MALLORY

MALLORY DISTRIBUTOR PRODUCTS COMPANY

a division of F. R. MALLORY & CO. INC.

Box 1558, Indianapolis, Indiana 46206; Telephone: 317-636-5353

Batteries • Capacitors

Cassette Tapes

Controls • Resistors • Semiconductors • Sonalert® • Switches • Timers • Vibrators • ICs

CIRCLE NO. 122 ON READER SERVICE CARD

Directory of
1970 COLOR-TV SETS



THIS MONTH'S COVER shows a grouping of small, portable color-TV sets in a holiday-gift setting. Tied in with this illustration is our 2-page chart directory on the new 1970 color-TV chassis along with their features and specifications. The receiver at the left is the 11-in Magnavox Model 6104, priced at around \$260. At the top is a prototype of the new, all-solid-state 9-in Panasonic portable Model CT-991P, expected to sell for around \$330. The set at the right is the General Electric Model WM229HWD, a 10-in portable that sells for around \$220. We have simulated the color-TV pictures on these receivers with photos from the Swiss National Tourist Office. Cover photograph by Dirone-Denner.



Publisher **LAWRENCE SPORN**
Editor **WM. A. STOCKLIN**
Technical Editor **MILTON S. SNITZER**
Associate Editors
P. B. HOEFER
MURRAY SUNTAG
Contributing Editors
WALTER H. BUCHSBAUM
Prof. ARTHUR H. SEIDMAN
FOREST H. BELT
Art Editor **RICHARD MOSS**
Technical Illustrator
J. A. GOLANEK
Advertising Manager
JOSEPH E. HALLORAN
Marketing Manager
ROBERT UR
Advertising Service Manager
MARGARET DANIELLO

January, 1970

Electronics World

JANUARY 1970

VOL. 83, No. 1

CONTENTS

25	Television: 20 Years From Now	<i>Forest H. Belt</i>
30	Recent Developments in Electronics	
32	Directory of 1970 Color-TV Chassis	
34	Equalizing The Sound System to Match The Room	<i>Don Davis and Don Palmquist</i>
37	Electromagnetic Spectrum Chart	
38	Sound Chart	
39	Scintillation Radiological Survey Meters	<i>J. G. Eilo</i>
44	Taming Radar Weather Clutter	<i>Howard L. McFann</i>
46	TV-FM Lead-In: What Kind to Use?	<i>Thomas R. Haskell</i>
53	Results of Japanese Tests on Color-TV	<i>James Yagi</i>
66	Microstripline Parameters	<i>Leon Sales</i>
68	IC 12- to 6-V Converter	<i>E. A. Sock</i>
74	Solid-State V.O.M.	<i>Jim Ashe and John Eisenberg</i>
78	SCS Positive-Pulse Generator	<i>Frank H. Tooker</i>
86	Silicon Transistors as Zeners	<i>J. Charles</i>
87	Sensitive Intrusion Alarm	<i>Frank H. Tooker</i>
88	Testing VW's Electronic Fuel-Injection System	<i>Fred W. Holder and R. David Springs</i>
94	Magnetic Recording Industry Worldwide Sales	
96	Electronics World 1969 Index (Vols. 81-82)	

6	EW Lab Tested	<i>Kenwood KT-7000 AM/Stereo-FM Tuner</i> <i>Scott S-15 Speaker System</i>
56	Electronics And The Body	<i>John Frye</i>
64	Test Equipment Product Report	<i>Triplet Model 5000 Digital Panel Meter</i> <i>B&K Model 162 Transistor Tester</i> <i>Sencore CG18 Color-Bar Generator</i>

MONTHLY FEATURES

4	Coming Next Month	23	News Highlights
12	Letters From Our Readers	84	Book Reviews
15	Radio & Television News	90	New Products & Literature

Electronics World: Published monthly by Ziff-Davis Publishing Company at One Park Avenue, New York, New York 10016. One year subscription \$7.00. Second Class Postage paid at New York, New York and at additional mailing offices. Subscription service and Forms 3579: Portland Place, Boulder, Colorado 80302. Copyright © 1969 by Ziff-Davis Publishing Company. All rights reserved.



**NEW
HOLLOW
SHAFT**

nutdriver set

with Locknut/Screw
adjusting feature

Speeds, simplifies setting of combination locknut/slotted screw adjustments on rheostats and similar controls used in a wide variety of electrical and electronic equipment.

Handle is drilled so you can run an 8" screwdriver blade right through its center and down through the hollow nutdriver shaft.



Ideal for all-around production, maintenance, and service work, this new HSC-1 Set contains eight interchangeable hollow nutdriver shafts in the most popular hex opening sizes from 3/16" thru 9/16".



Really compact! Set is small enough, light enough to carry in your hip pocket. Sturdy, see-thru, plastic carrying case doubles as a bench stand.

WRITE FOR BULLETIN N867



XCELITE, INC., 12 Bank St., Orchard Park, N. Y. 14127
In Canada contact Charles W. Pointon, Ltd.
CIRCLE NO. 101 ON READER SERVICE CARD

COMING NEXT MONTH

SPECIAL FEATURE ARTICLES:

4-CHANNEL STEREO



There is tremendous excitement within the hi-fi industry regarding 4-channel stereo reproduction—the new "surround sound." It started not too long ago in Boston and was also in evidence at the Los Angeles Hi-Fi Show. Since then, we've had 4-channel FM broadcasts in Boston and, more recently, in New York. Electronics World will bring you several articles on this subject including a discussion of recording techniques (there are different opinions of which is best). We'll also cover proper speaker placement in the home and the psychological effects of 4-channel stereo. Noted authorities like Bob Berkovitz (Acoustic Research) and Russ Molloy (Telex-Magnecord-Viking) will give us their views.

ELECTRONICS & THE HEART

Fred Holder (Bendix Field Eng. Corp.) will discuss the various electronic developments in equipment and systems now being used for prolonging the life of heart patients. Great efforts are being made in this field and there are many exciting new electronic developments.

COLOR TV FOR 1970

The first of a 2-part series by Forest Belt covers most of the new circuits that have made their debut in the 1970 line of color-TV receivers.

DESIGN & CONSTRUCTION OF REGULATED POWER SUPPLIES

Design considerations and general construction hints for a very stable, inexpensive, regulated power supply. In addition, the article specifically details a 20-volt, 1.5-ampere regulated supply with better than 1% regulation.

ELECTRONIC DICE

Design and construction of an electronic die used in games of chance. A novel approach by R. W. Fox of GE Semiconductor Products Div.

ZIFF-DAVIS PUBLISHING COMPANY

William Ziff
President

W. Bradford Briggs
Executive Vice President

Hershel B. Sarbin
Senior Vice President

Philip Sine
Financial Vice President

Walter S. Mills, Jr.
Vice President, Circulation

Stanley R. Greenfield
Vice President, Marketing

Phillip T. Heffernan
Vice President, Electronics Division

Frank Pomerantz
Vice President, Creative Services

Arthur W. Butzow
Vice President, Production

Edward D. Muhlfeld
Vice President, Aviation Division

Irwin Robinson
Vice President, Travel Division

Furman Hebb
Administrative Vice President

George Morrissey
Vice President

Sydney H. Rogers
Vice President

Editorial and Executive Offices
One Park Avenue
New York, New York 10016 212 679-7200

NEW YORK OFFICE 212 679-7200
Joseph E. Holloran, Adv. Mgr.
Michael E. Kelman

MIDWESTERN OFFICE
307 North Michigan Avenue
Chicago, Illinois 60601 312 726-0892
George B. Mannion, Jr.

WESTERN OFFICE
9025 Wilshire Boulevard
Beverly Hills, California 90211
213 Crestview 4-0265; Bradshaw 2-1161
Western Advertising Manager, Bud Dean

JAPAN: James Yagi, Ishikawa Mansion,
#4, Sakuragaoka Shibuya-ku, Tokyo 462-2911-3

CIRCULATION OFFICE
Portland Place, Boulder, Colorado 80302



Member
Audit Bureau of
Circulations

Radio & TV News • Radio News • Radio-Electronic Engineering Trademarks Reg. U.S. Pat. Off.
SUBSCRIPTION SERVICE: Forms 3579 and all subscription correspondence should be addressed to Electronics World, Circulation Department, Portland Place, Boulder, Colorado 80302. Please allow at least six weeks for change of address. Include your old address, as well as new—enclosing if possible an address label from a recent issue.
EDITORIAL CONTRIBUTIONS must be accompanied by return postage and will be handled with reasonable care; however publisher assumes no responsibility for return or safety of art work, photographs, or manuscripts.
ELECTRONICS WORLD (January, 1970, Vol. 83, No. 1). Published monthly at One Park Avenue, New York, New York 10016, by Ziff-Davis Publishing Company—also the publishers of Airline Management and Marketing, Boating, Business & Commercial Aviation, Car and Driver, Cycle, Flying, Modern Bride, Popular Electronics, Popular Photography, Skiing, Skiing Area News, Skiing Trade News, Stereo Review, and Travel Weekly. One year subscription rate for U.S., U.S. Possessions, and Canada, \$7.00; all other countries, \$8.00. Second Class postage paid at New York, N.Y. and at additional mailing offices. Authorized as second class mail by the Post Office Department, Ottawa, Canada and for payment of postage in cash.

Shocked? Don't be. Does this man *look* like a criminal? He's not. This man is in the business of *preventing* crime. (One of the fastest growing industries today.) He's a Radar Sentry Alarm dealer representative.

What could this possibly mean to you? Perhaps nothing. On the other hand, it could change your entire life.

As a Radar representative, you could make \$1,200 a month if you sold only one system each week. Most of our dealers make much more. Two sales a week would net you \$28,000 a year; five a week, \$46,000 a year. We make the finest solid state microwave burglar alarm system available; one that's easy to install and easy to service...for both home & business. We're presently expanding our organization of dealer representatives. We'll train you, provide you with leads and offer continuing counsel. You can operate full-time or part-time. Later, you may want to expand and organize your own sales staff.

But for now, let's get better acquainted. Fill out the coupon. In a few days, you'll receive complete details about how you can live a life of crime-and make it pay, *handsomely*.



Radar Sentry Alarm. The Crimebuster.

RADAR DEVICES MFG. CORP.
22003 Harper Ave., St. Clair Shores, Michigan 48080
Rush me RSA Distributor Info.
I understand there is no obligation. EW-1

Name _____

Address _____

City _____ State _____ Zip _____

Live a life of crime, honestly.



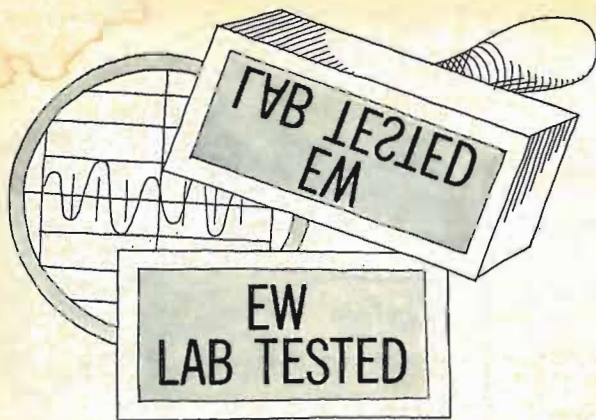

HI-FI PRODUCT REPORT

TESTED BY HIRSCH-HOUCK LABS

Kenwood KT-7000 AM/Stereo-FM Tuner Scott S-15 Speaker System

Kenwood KT-7000 AM/Stereo-FM Tuner

For copy of manufacturer's brochure, circle No. 1 on Reader Service Card.

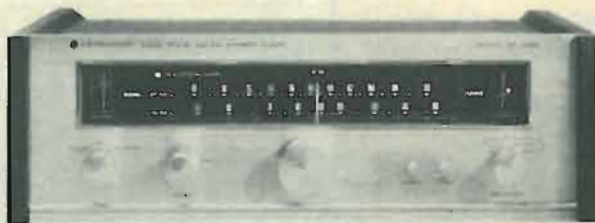

THE Kenwood KT-7000 AM/stereo-FM tuner matches the company's KA-6000 amplifier in styling and size. Its numerous circuit refinements help establish the KT-7000 in the top echelon of tuners. For example, the FM front end has two FET r.f. amplifiers, with three tuned circuits preceding the FET mixer. As a result, the KT-7000 is highly resistant to overload from strong local stations and from cross-modulation effects. The i.f. amplifier, with four integrated circuits (IC's), also has two crystal-filter stages replacing the usual i.f. transformers. These filters give the KT-7000 an almost ideal bandpass characteristic, with outstanding rejection of adjacent- and alternate-channel signals. Most i.f. alignment requirements are eliminated, and other secondary benefits include a linear phase characteristic that shows up in the form of very uniform stereo separation over the full audio range.

The ratio-detector output goes to a conventional multiplex demodulator, in which the 38-kHz subcarrier is recon-

stituted by frequency doubling of the 19-kHz pilot carrier. The KT-7000 has interstation-noise muting and automatic stereo switching on FM using some moderately complex circuitry. We noted from the schematic diagram that some nine transistors and a number of diodes are employed for these functions. The left- and right-channel audio signals from the multiplex circuit go to individual three-stage audio amplifiers with low-impedance emitter-follower outputs. Within the audio amplifiers are the 38-kHz traps that effectively eliminate ultrasonic components from the outputs, thus preventing "birdies" when tape recording from FM broadcasts.

The audio outputs are normally taken through a six-position step attenuator, which matches the tuner level to the requirements of the associated amplifier and speaker systems. A second pair of outputs is then taken off ahead of the attenuator for feeding a tape recorder. There is also a mono output that is connected to the input of the multiplex section.

The Kenwood KT-7000 has a handsome appearance. It has a gold-colored front panel with a brushed-satin finish, an edge-lighted slide-rule dial (which is opaque with power off), and fluted control knobs. The tuning knob, which is larger than the others, has a peculiar "rubbery" feel. However, the tuning is unusually smooth and noncritical, probably because of the "flat-topped" i.f.-response characteristic.

There are two meters, a signal-level indicator for FM and AM, and a zero-center tuning meter for FM with a red stereo-indicator lamp at its center. We found this to be most convenient, since there is a tendency to watch the pointer while tuning a station and one's eyes

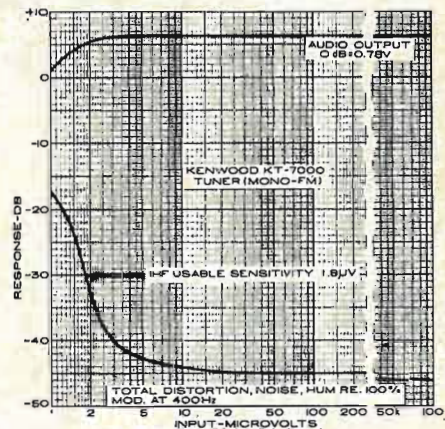

need not move from that spot to determine the presence of stereo.

The AM tuner, which we did not test except by listening, appears to be quite conventional. It has a ferrite-rod antenna, tuned r.f. stage, separate mixer and oscillator stages, two i.f. amplifiers, and a diode detector. However, there is evidently more to it than appears on the surface, since it is one of the best sounding AM tuners we have heard in years.

The control lineup, in addition to the tuning knob and mode selector, includes a combined power and FM interstation-noise muting switch and the output attenuator. The latter, we feel, could just as well have been located in the rear, since it is unlikely to be used once it is correctly set. Two blue pilot lamps on the front panel indicate the use of muting and the multiplex filter. The filter

(Continued on page 58)

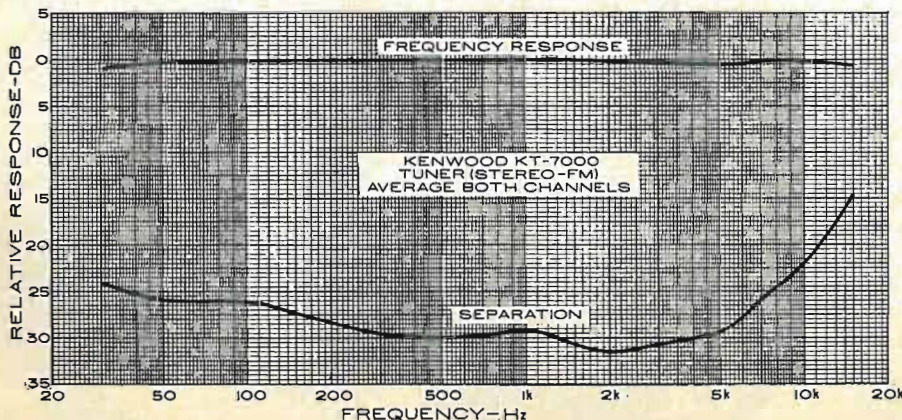

**JFD is ready!... 20 million homes are ready!...
Get ready... get set... go with new**

JFD Home Entertainment Program Center Kits

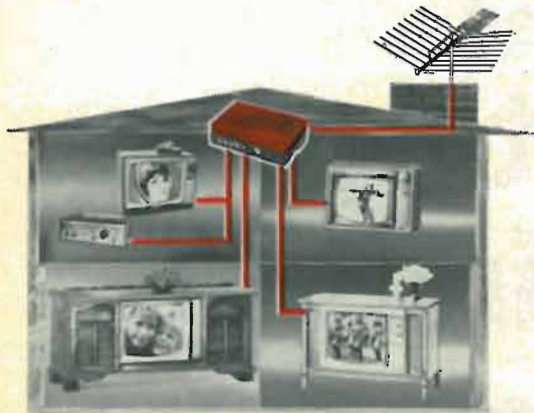

- ★ Provide up to 4 TV sets with *different* programs — from 1 antenna.
- ★ Beautifully packaged in *full-color carry-home* display carton.
- ★ Distribution amplifier powerful enough to drive up to 12 sets — with additional splitters.

Whether you install it yourself or sell it over-the-counter, the unique JFD Home Entertainment Program Center Kit gets you in on the ground floor of a lucrative new untapped market — 20 million households with two or more sets that can use a distribution system.

Make every home an entertainment center!

Thousands of old home owners, new home owners, contractors, and builders in your area are ready-to-buy prospects for (4) JFD Program Center Kits

**Easy to sell!
Easy to install!**

SEE YOUR DISTRIBUTOR
OR WRITE FOR OUR PROMOTION KIT



JFD ELECTRONICS CORP.

15 AVENUE AT 82 STREET, BROOKLYN, NEW YORK 11219

JFD INTERNATIONAL, 2200 SHAMES DRIVE, WESTBURY, N.Y. 11590 / JFD CANADA LTD., ONTARIO, CANADA

JFD DE VENEZUELA, S.A., AVENIDA LOS MÁTICOS 125-87, MARACAIBO, VENEZUELA

© 1982 JFD



firsts

make learning
Electronics at home
fast and fascinating—
give you priceless
confidence.

Some NRI **firsts** in training equipment



first to give you Color Television training equipment engineered specifically for education — built to fit NRI instructional material, *not* a do-it-yourself hobby kit. The end product is a superb Color TV receiver that will give you and your family years of pleasure. You “open up and explore” the functions of each color circuit as you build.

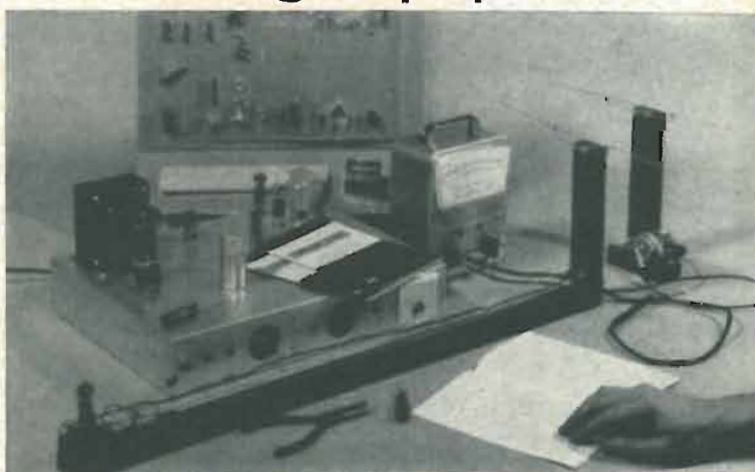

first to give you transmission lines and antenna systems that include experiments not otherwise attempted outside of college physics laboratories. The experience gained with this kind of Communications training equipment is matched only by months — sometimes years — of on-the-job experience.

NRI's "discovery" method is the result of over half a century of leadership simplifying and dramatizing training at home

The FIRSTS described below are typical of NRI's half century of leadership in Electronics home training. When you enroll as an NRI student, you can be sure of gaining the in-demand technical knowledge and the priceless confidence of "hands-on" experience sought by employers in Communications, Television-Radio Servicing and Industrial and Military Electronics. Everything about NRI training is designed for your education . . . from the much-copied, educator-acclaimed Achievement Kit sent the day you enroll, to "bite-size" well-illustrated, easy to read texts programmed with designed-for-learning training equipment.

YOU GET YOUR FCC LICENSE OR YOUR MONEY BACK

There is no end of opportunity for the trained man in Electronics. You can earn \$6 or more an hour in spare time, have a business of your own or qualify quickly for career positions in business, industry, government. And if you enroll for any of five NRI courses in Communications, NRI prepares you for your FCC License exams. *You must pass* or NRI refunds your tuition in full. No school offers a more liberal money-back agreement. The full story about NRI leadership in Electronics training is in the new NRI Catalog. Mail postage-free card today. No salesman is going to call.
NATIONAL RADIO INSTITUTE, Washington, D.C. 20016

APPROVED UNDER NEW GI BILL If you have served since January 31, 1955, or are in service, check GI line on postage-free card.

designed from chassis up for your education



first to give you true-to-life experiences as a communications technician. Every fascinating step you take in NRI Communications training, including circuit analysis of your own 25-watt, phone/cw transmitter, is engineered to help you prove theory and later apply it on the job. Studio equipment operation and troubleshooting become a matter of easily remembered logic.



first to give you completely specialized training kits engineered for business, industrial and military Electronics. Shown above is your own training center in solid state motor control and analog computer servo-mechanisms. Telemetry circuits, solid-state multi-vibrators, and problem-solving digital computer circuits are also included in your course.

- ✓ Increase Engine Power
- ✓ Increase Gas Mileage
- ✓ Reduce Engine Maintenance
- ✓ Instant Starting in All Climates

Bay CAPACITIVE DISCHARGE IGNITION SYSTEM

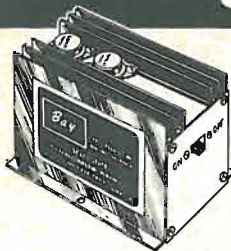

Order Today!
ONLY

\$29.95

Completely wired, ready-to-install (not a kit)

- Easy installation (use original coil)
- Solid state reliability
- G-10 type spacecraft circuit board
- Distributor points last lifetime of car
- Spark plugs last 3 to 10 times longer
- No changes required on timing or dwell
- **EXCLUSIVE** built-in switch for instant change from CD unit to standard ignition system while engine is running (for tune-ups, testing)
- For 12-volt negative ground systems only
- 1-year written guarantee

DEALER / DISTRIBUTOR INQUIRIES INVITED!

Bay PRODUCTS, INC. E-1

P.O. Box 9562, Houston, Texas 77011

Please send _____ Model SW100 Capacitive Discharge Ignition Systems @ \$29.95.
Enclosed is \$ _____ Ship ppd. Ship C.O.D.

Name _____

Address _____

City/State _____ Zip _____

CIRCLE NO. 147 ON READER SERVICE CARD
12

LETTERS FROM OUR READERS



WEATHER-BUREAU BROADCASTS

To the Editors:

I have been listening to the official U.S. Weather Bureau radio broadcasts in the New York City area for some time. These are FM broadcasts on the v.h.f. frequency of 162.55 MHz. The reports are very detailed and they are updated every few hours, so that I consider them a very useful service. Since I am moving to San Francisco shortly, will I be able to continue to receive the local forecasts for that city on this special weather frequency?

JOHN STEINER
Bellerose, N. Y.

In 1967 there were only four Weather-Bureau stations operating on 162.55 MHz. Now, however, this service has been expanded to the following nineteen cities, with more to be added in the future: New York, Chicago, Los Angeles, San Francisco, Honolulu, Kansas City, Washington, Boston, New Orleans, Lake Charles, Baton Rouge, Corpus Christi, Galveston, Norfolk, Atlantic City, Jacksonville, Tampa-Clearwater, and Miami. So you will be able to continue to receive the local broadcasts on your v.h.f. FM receiver.—Editors

* * *

ELECTRONIC IGNITION SYSTEM

To the Editors:

I have read with great interest Herb Keroes' recent article in the July ELECTRONICS WORLD entitled "High-Q Inductive Electronic Ignition System." It is refreshing to see a different approach to an old problem.

However, I question what I consider an omission from the article. You make mention of comparisons of the high-"Q" system with what you choose to call a "conventional" electronic system. Further, you define the "conventional" electronic system as one which uses only solid-state switching between the distributor points and the coil.

But what about the capacitive-discharge system? How does the high-"Q" inductive system compare with a capacitive-discharge system which is infinitely better than the simple "conventional" switching system?

EUGENE A. WILLIE, Chief Engineer
Voice of America Hue Relay Station
Hue, Vietnam

Our author has not made any direct comparisons with C-D systems. However, from the experiences of others, he feels that his own system should give better performance at high speeds due to the greater energy content of the firing pulses produced.—Editors

PRINTED CIRCUIT SECTION

To the Editors:

I must, in all sincerity, extend my kudos for the marvelous Special Section on "Printed Circuits" in October's ELECTRONICS WORLD. It was profound, to say the least.

After 38 years of serving the public in the consumer electronics line, from pocket radios to CB, car stereo, and amateur equipment, I shut down operations to return to school. I am taking an engineering drafting course lasting one year, with intent to branch out into printed-circuit drafting. I have been studying two years.

My library on the subject is now approaching 3000 pages, and the cost is near \$200, but you and your staff have edited almost all of this information down to 24 pages of ELECTRONICS WORLD.

JOSEPH T. BECK
Beck Radio Service
Tampa, Fla.

* * *

MULTICHANNEL RECORDING

To the Editors:

Ron Wickersham's article, "Multichannel Recording for Creating the 'New Sound'" in the Sept., 1969 issue, gives an insight into the technical considerations involved in 16-track recording. However, the failure to explain the Ampex sel-sync system, which makes the new multichannel recording techniques possible, leaves a reader without prior knowledge of multitrack recording techniques in the dark.

With a conventional three-head recorder, putting additional music on a second track while listening to a first track has one serious drawback. Since the playback head is a few inches away from the record head, the material recorded on the second track, when played back, will be heard a short time after the material on the first track. Thus, the two tracks are not in synchronization.

In simple terms, sel-sync (for *selective synchronization*) utilizes the record head to play back the previously recorded tracks. The performer monitors this playback, and records additional tracks using the *same* head stack as he is monitoring from. Thus, all tracks are in synchronization.

HOWARD G. MULLINACK, Chief Engineer
WNEU, Northeastern Univ.
Boston, Mass.

* * *

MEDICAL ELECTRONICS SERVICING

To the Editors:

Please accept my congratulations on your article, "Medical Electronics Servicing" by John Frye in the October issue of *ELECTRONICS WORLD*. It was a welcome change for me to read an article of this type in your magazine. You were very clear in explaining some of the specialized equipment not familiar to other readers, and the fact that one must be prepared to work long hours and take care of the equipment when it fails.

I can assure you that some of the problems encountered are not quite so obvious as those found in industrial equipment, and that a good background in theory is essential.

I hope this article will draw some good technicians to the medical field who will be needed to repair and service everything from a computer to a heart-lung machine.

JOSEPH LEWANDOWSKI
Presbyterian—University of Pa.
Medical Center
Philadelphia, Pa.

* * *

HOMEMADE BATTERY

To the Editors:

In your November, 1968 issue of *ELECTRONICS WORLD* there appeared an article on the silver chloride-magnesium battery.

After re-reading your very interesting article, I, with the help of my high school (Beecher City Comm.) chemistry teacher, constructed a one-cell battery. We boiled down a precipitate which yielded an $AgCl$ electrode, and used a magnesium strip for the other electrode, placing both in a salt-water electrolyte. Using a v.o.m., we read a maximum of 1.75 volts. This voltage plus several outstanding characteristics impressed many of the students; however, to my dismay, I found one bad trait. I used alligator clips, of unknown composition, which were hooked to the electrodes, then to the meter. The clip hooked on the $AgCl$ electrode was involved in the reaction, and within 12 hours, it crumbled like a cracker.

NEAL HELMBACHER
Shumway, Ill.

Obviously, the battery manufacturer uses terminals made of different material.—Editors ▲

NOW— CHECK ALL TRANSISTORS IN OR OUT OF CIRCUIT...

Flick function switch to left to check all regular transistors.

Flick function switch to right to check any FET.

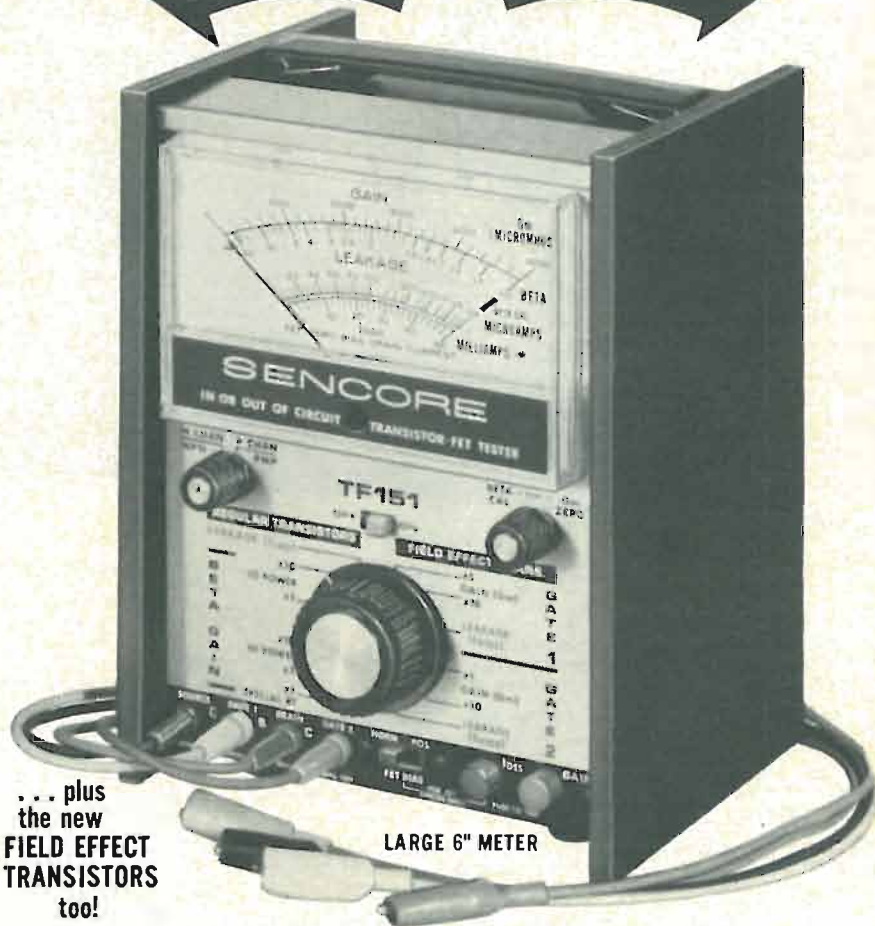

... plus the new FIELD EFFECT TRANSISTORS too!

LARGE 6" METER

You won't be stopped when you run into the new FETs that are wired into the latest hi-fi, newest TV receivers and nearly every other new device coming on the market. For the very first time, you can check them all, in or out of circuit. The TF151 works every time using tried and proven signal injection techniques. New, improved tests on special RF transistors and the latest high power transistors, mean that the TF151 is the only up-to-date transistor tester on the market. A new, exclusive setup book in rear compartment guides you to every test for over 12,000 transistors and FETs. The book is not needed for general service troubleshooting. Regular transistors are checked for beta gain and I_{cbo} leakage. FETs are checked for transconductance and I_{gss} leakage. **only \$129⁵⁰**

NEW SENCORE TF17 compact in and out of circuit transistor FET tester. Same as TF151 except in new Sencore Handi case and with 4-1/2" meter. . . \$109.50



SENCORE

NO. 1 MANUFACTURER OF ELECTRONIC MAINTENANCE EQUIPMENT

426 SOUTH WESTGATE DRIVE, ADDISON, ILLINOIS 60101

CIRCLE NO. 108 ON READER SERVICE CARD

Announcing the **NEW STANDARD** in Stereo Testing!

Get the All-New Model SR12 STEREO TEST RECORD

The most complete... most sophisticated... most versatile
Test Disc available today... **For Just \$4.98!**

Who Needs the New Model SR12?

If you've read this far, you do. Whether you're an avid audiophile who'll settle for nothing but peak performance from his stereo components... a casual listener who'd like more insight into the challenging world of stereo reproduction... or a professional technician who needs precise standards for lab testing... the new MODEL SR12 will be the most important disc in your entire collection.

Stereo Review's
STEREO TEST RECORD
MODEL SR12
FOR HOME AND LABORATORY USE

A HIGHLY EFFECTIVE AND ACCURATE TOOL
FOR SETTING UP, ADJUSTING, AND
EVALUATING STEREO SYSTEMS

Like its predecessor Model 211, MODEL SR12 has been produced by Stereo Review Magazine (formerly HiFi/Stereo Review) as a labor of love — by music lovers... for music lovers who want immediate answers to questions about the performance of their stereo systems and how to get the best possible sound reproduction.

Now greatly expanded and updated with the most modern engineering techniques, MODEL SR12 is the most complete test record of its kind — containing the widest range of checks ever included on one test disc. An ear-opener for every serious listener!

You'll make these important stereo checks BY EAR... (no test instruments of any kind required)

- ▶ Frequency response—a direct warble-tone check of nineteen sections of the frequency spectrum, from 20 to 20,840 Hz, which will pinpoint any frequency response defects in your system.
- ▶ Separation—an ingenious test which indicates whether you have adequate separation for good stereo.
- ▶ Cartridge tracking—the most sophisticated tests ever devised for checking the performance of your cartridge, stylus and tone arm.
- ▶ Channel balance—two broad-band, random-noise signals which permit you to eliminate any imbalances originating in cartridge, amplifier, speakers or room acoustics.
- ▶ Hum and rumble—foolproof tests that help you evaluate the actual audible levels of rumble and hum in your system.
- ▶ Flutter—a sensitive "musical" test to check whether your turntable's flutter is low, moderate, or high.

PLUS! • Cartridge and Speaker Phasing • Anti-Skating Adjustment • "Gun Shot Test" for Stereo Spread • Multi-purpose Musician's "A" • Equal-tempered Chromatic Octave • Guitar-tuning Tones.

Don't waste another minute on less-than-perfect stereo—Order Your Model SR12 Stereo Test Record NOW!

Consider the hundreds—even thousands—you've spent on your set-up and you'll agree \$4.98 is a small price to pay for the most valuable performance tool ever made. So to be sure your order is promptly filled from the supply available, mail the coupon at right with your remittance... today!

AND, for the ultimate in stereo testing, 7 critical TEST EQUIPMENT checks...

Attention professionals: Stereo Review's new Model SR12 Stereo Test Record is also designed to be used as a highly efficient design and measurement tool. In the following tests, recorded levels, frequencies, etc. have been controlled to laboratory tolerances—affording accurate numerical evaluation when used with oscilloscope, chart recorder, output meter, intermodulation-distortion meter and flutter meter.

- 1,000-Hz square waves to test transient and high-frequency response of phono pickups.
- 500 to 20,000 Hz frequency-response sweep.
- Sine-wave tone-bursts to test transient response of pickup.
- Intermodulation test using simultaneous 400-Hz and 4,000-Hz signals.
- Intermodulation sweep to show distortion caused by excessive resonances in tone arm and cartridge.
- 1,000-Hz reference tones to determine groove velocity.
- 3,000-Hz tone for flutter and speed tests.

Sample waveforms—illustrating both accurate and faulty responses are provided in the Instruction Manual for comparison with the patterns appearing on your own oscilloscope screen.

FREE Instruction Manual Includes Detailed Instructions, Charts, Tables and Diagrams.

Nothing is left to chance... or misinterpretation. Every segment of every band is fully, clearly, graphically explained. You'll know exactly what responses to listen for in each test. Which sounds and patterns indicate accurate performance... which ones spell trouble... as well as the cause of trouble and precise corrective measures to follow and help you pinpoint, analyze and cure your stereo headaches!

Records • Ziff Davis Service Division
595 Broadway • New York, N.Y. 10012

EW-1-70

Please send _____ test records at \$4.98 each, **postpaid.**

My check (or money order) for \$ _____ is enclosed.

(Outside U.S.A. please send \$7.00 per record ordered.) N. Y. State residents please add local sales tax.

Print Name _____

Address _____

City _____

State _____

Zip _____

PAYMENT MUST BE ENCLOSED WITH ORDER

Another Political Fire to Quench

It's enough to make a TV manufacturer paranoid. An alarm is ringing in newspapers for an end to "fires" in television receivers. The fact that the incidence of fires in TV receivers is only a few thousandths of a percent hasn't been stressed. One story said 10 deaths were attributed to TV-caused fires. It didn't mention that there are now 85 million sets in use. The source of the stories is a report of the National Product Safety Commission.

Television producers are acting predictably, with worry and haste, mindful of the long-drawn-out adverse publicity over color-TV x-rays. The news began hitting the newspapers just as dealers were girding for a hopeful push toward high Christmas sales. We don't know the results at press time, but you can bet the fire-scare noise is drowning out some well-planned sales pitches. With 80 million automobiles, we have 50,000-plus auto deaths a year. Someone seems to be scratching pretty deep to find some issue to hit the TV industry with.

Trends in Factory-Owned Service

RCA unabashedly set up *RCA Service Co.* years ago. It touched off plenty of objection by independent service dealers—especially those who sold and serviced *RCA*. But the cries were ineffective if not unheeded. It has become a giant, and competes with independent service in most cities. *General Electric* has factory-owned repair stations. *Admiral* has a regional operation. A non-manufacturer, *Sears-Roebuck*, has one of the nation's most extensive "captive" service operations. Others exist, but with less fanfare. Still other manufacturers have tried it and given up.

Latest to capture notice is *Sylvania*. It bought Philadelphia's largest TV shop, Alert TV. This adds to other scattered *Sylvania*-owned service companies. There's no overt trend, but signs suggest this may spread nationwide. If it does, or even spreads noticeably, there'll be strong objections from independent service organizations.

Are objections entirely fair? Of course, there is a solid nucleus of businessmen/technicians around the country who own and operate competent, solvent shops. However, thousands in the servicing industry won't spend money on technical training, won't spend time on training even when it's free, won't give more than passing thought to learning business management, won't join an association, won't admit that many problems are of their own making so they can set about correcting them. Manufacturer spokesmen that we have talked with recently seem short of patience with this particular type of individual, and rightly so.

Indeed, why *shouldn't* manufacturers develop their own service organizations? Programs sponsored by service associations both local and national, aided often by manufacturers, are helpful. But they aren't extensive enough to lick the big problem. And they don't have any more luck attracting those thousands who "won't" than schools or manufacturers do. So, energy spent battling a trend toward factory-owned service shops is energy wasted. And perhaps unwisely, to boot.

X-Ray Filter Glass for CRT

A special glass formula using strontium carbonate will go into faceplates of many 1970 color picture tubes. The reason: to absorb even better any x-rays that might be released by the CRT beams bombarding the color phosphors. The new glass has an absorption coefficient up to five times as effective as the glass used in most present tubes.

RCA is the only CRT-producer we've heard of so far that will have the new glass right away, but others are sure to follow. Early in 1970, *RCA* color picture tubes are expected to include x-ray shielding in the bell, too. That should lay to rest another of the worries of consumers who believed all that x-ray scare publicity.

Christmas Color Fraud

Newest gimmick figured out by the cheats, frauds, and gyps is the false-face color-TV. It's merely a cheap black-and-white set that's been doctored a little. First, a plastic sheet with three strips of color is pasted over the screen. Then, little rainbow-colored decals are pasted beside a couple of knobs. Then the

chassis is stamped "color filter installed." Finally, a large rainbow is glued on the carton. Lo and behold: a name-brand TV set ready to be peddled to some unsuspecting buyer as a color set. The bait, of course, is a real "bargain" color-set price—usually two or three times the true selling price of the undoctored set. This fraud was reported in New York City early in the Christmas selling season. It popped up in a few other cities, too.

Are Parts Available or Not?

Judging from complaints by technicians at a recent national service conference, they are not. Yet, more than one manufacturer's man there insisted there's no problem. We decided to spot-check on our own. Certain specific parts for major color brands were requested at the local distributor for those sets. In every case, at least one part was not in stock and would not be available for a week to three weeks.

In one instance, a part was not available anywhere in the surrounding region, even from the company's own service organization. Twice we were told the part "doesn't ever go bad" and so is never stocked. The part requested actually *was* bad, in a set received dead-on-arrival in its carton.

We hear that some set-makers are making special efforts to combat this "nonexistent" problem. Good. But we suggest this, from our own observations: (1) Don't pretend to service-industry leaders that the problem doesn't exist; they know better. (2) Distributors shouldn't base their parts stock entirely on what's popular; that's unfair to the customer who buys other brands, and to the technician who is unfortunate enough to have to service them.

Another VTR Approach

Periodically, there's another announcement of some method for home video recording. Now it's two Japanese companies. Their timing follows closely the announcement last month of RCA's holographic video recordings.

First, *Sony* tells about a machine that plays a cassette that has in it about 90 minutes' worth of video-and-sound-recorded 3/4-inch magnetic tape. The advantage is low cost: under \$500 for the player and \$20 for blank cassettes. An off-air recording attachment makes the unit sell for \$100 more. Shortly after, *Matsushita* (Panasonic) displayed a prototype of a similar video-cassette player at a convention of the National Association of Educational Broadcasters.

The odd thing about all these announcements, including the RCA and the earlier CBS/Motorola EVR announcements, is this: None of these companies can yet deliver a working unit to the market. All await further development, and you won't see some of them for sale until 1971 or 1972. Jumping the gun with announcements seems to be a fad in video recording.

Crystal-Gazing the Decade

At the start of every year, writers—especially of news columns—are afflicted with a passion to predict. They, and their readers, get caught up in a concern for what the ensuing year is to bring. It's seldom they get the opportunity to anticipate a whole decade (after all, how often does one begin?). But here it is, the start of the 1970's, and we just must have our brief stint of forecasting.

It's late 1979. Color-TV dominates home entertainment. But much of it's packaged differently. You buy color-video cartridges and play "canned" programs that suit just your taste. Sports, humor, musicals, variety. There are also plenty of programs on air and cable, but you can buy and play the special-interest stuff you want. Pay-TV is passé, having survived the fad years but making no big or lasting impact.

The most exciting television is cultural and educational. Instruction techniques unpracticed 10 years earlier make learning from TV efficient and even a pleasure. The best of art and science blend in a cultural renaissance that's free to anyone. Color-TV is the purveying medium, mainly through our national satellite and its worldwide hookup.

There's plenty of hardware. Of nearly 100 million TV sets, 80 million are color. Tape machines, mostly cassette, play much of the music. Yet, disc records are still around; 3 million players are sold each year. FM radio has swept the country; AM stations are dwindling. There's no such thing as an AM-only portable.

Prices are hard to compare with those of 10 years ago. Business downturns in the first years of the decade bounced values around a lot. The economy is more level now, and people can afford some home electronics as never before.

. . . That's only a brief picture, but an educated one. (There's an extended forecast on page 25, telling what the whole TV industry will be like 20 years from now.) ▲

*It took more than skill
to design the world's
smallest complete mobile
5-watt CB
transceiver*



Johnson Messenger 125

\$99⁹⁵

Only the famous Johnson "talk-power" is big as ever on Johnson's radically new Messenger 125! Virtually every vehicle on the road, including the 1969 and 1970 models, can easily accommodate this versatile new radio. Its far-ahead features make operation extremely simple and enjoyable. Best of all, we sliced the most out of the price!

Features

- 5 push button channels—no knobs ■ slide-lever vol. and squelch
- World's smallest panel configuration—1 $\frac{1}{16}$ " by 4 $\frac{1}{32}$ ", just 7" deep
- 4 watts output at 13.8 VDC ■ Accessories for portable use

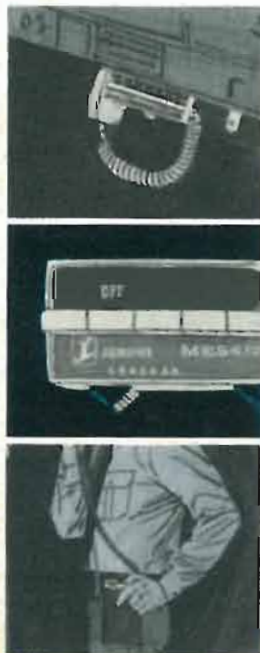

E. F. JOHNSON CO.
WASECA, MINNESOTA 56093

CIRCLE NO. 127 ON READER SERVICE CARD

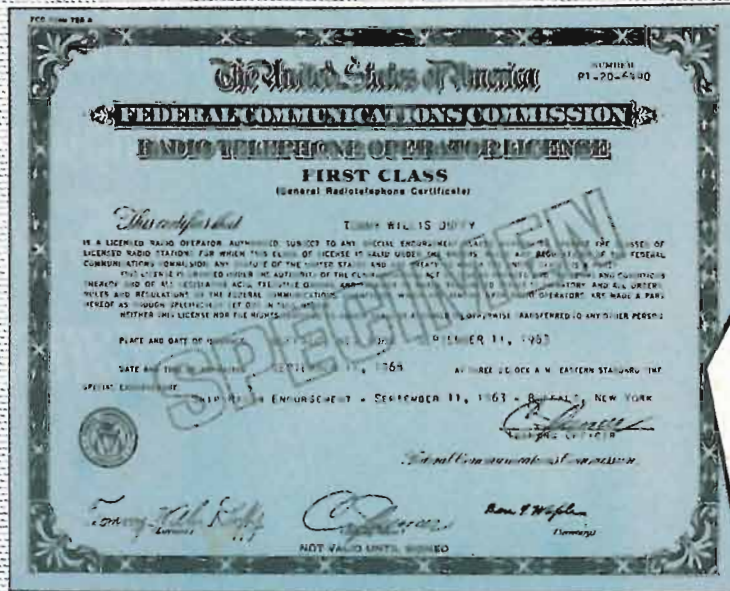

Better than
9 out of 10
CIE men win
their "ticket"
the very first
time they try
**(NATIONAL AVERAGE
IS ONLY 1 OUT OF 3)**

Cleveland Institute of Electronics

WARRANTY

of success in obtaining a Government FCC License

The Cleveland Institute of Electronics hereby warrants that upon completion of the Electronics Technology, Broadcast Engineering, or First-Class FCC License course, you will be able to pass the FCC examination for a First Class Commercial Radio Telephone License (with Radar Endorsement);

OR upon completion of the Electronic Communications course you will be able to pass the FCC examination for a Second Class Commercial Radio Telephone License;

AND in the event that you are unable to pass the FCC test for the course you select, on the very first try, you will receive a FULL REFUND of all tuition payments.

This warranty is valid for the entire period of the completion time allowed for the course selected.

G. O. Allen

You can earn more money if you get an FCC License

...and here's our famous CIE warranty that you will get your license if you study with us at home

NOT SATISFIED with your present income? The most practical thing you can do about it is "bone up" on your electronics, pass the FCC exam, and get your Government license.

The demand for licensed men is enormous. Ten years ago there were about 100,000 licensed communications stations, including those for police and fire departments, airlines, the merchant marine, pipelines, telephone companies, taxicabs, railroads, trucking firms, delivery services, and so on.

Today there are over a million such stations on the air, and the number is growing constantly. And according to Federal law, no one is permitted to operate or service such equipment without a Commercial FCC License or without being under the direct supervision of a licensed operator.

This has resulted in a gold mine of new business for licensed service technicians. A typical mobile radio service contract pays an average of about \$100 a month. It's possible for one trained technician to maintain eight to ten such mobile systems. Some men cover as many as fifteen systems, each with perhaps a dozen units.

Coming Impact of UHF

This demand for licensed operators and service technicians will be boosted again in the next 5 years by the mushrooming of UHF television. To the 500 or so VHF television stations now in operation, several times that many UHF stations may be added by the licensing of UHF channels and the sale of 10 million all-channel sets per year.

Opportunities in Plants

And there are other exciting opportunities in aerospace industries, electronics manufacturers, telephone companies, and plants operated by electronic automation. Inside industrial plants like these, it's the licensed technician who is always considered first for promotion and in-plant training programs. The reason is simple. Passing the Federal government's FCC exam and getting your license is widely accepted proof that you know the fundamentals of electronics.

So why doesn't everybody who "tinkers" with electronic components get an FCC License and start cleaning up?

The answer: it's not that simple. The government's licensing exam is tough. In fact, an average of two out of every three men who take the FCC exam fail.

There is one way, however, of being pretty certain that you will pass the FCC exam. And that is to take one of the FCC home study courses offered by the Cleveland Institute of Electronics.

CIE courses are so effective that better than 9 out of every 10 CIE-trained graduates who take the exam pass it. That's why we can afford to back our courses with the iron-clad Warranty shown on the facing page: you get your FCC License or your money back.

There's a reason for this remarkable record. From the beginning, CIE has specialized in electronics courses designed for home study. We have developed techniques that make learning at home easy, even if you've had trouble studying before.

In a Class by Yourself

Your CIE instructor gives his undivided personal attention to the lessons and questions you send in. It's like being the only student in his "class." He not only grades your work, he analyzes it. Even your correct answers can reveal misunderstandings he will help you clear up. And he mails back his corrections and comments the same day he receives your assignment, so you can read his notations while everything is still fresh in your mind.

It Really Works

Our files are crammed with success stories of men whose CIE training has gained them their FCC "tickets" and admission to a higher income bracket.

Mark Newland of Santa Maria, Calif., boosted his earnings by \$120 a month after getting his FCC License. He says: "Of 11 different correspondence courses I've taken, CIE's was the best prepared, most interesting, and easiest to understand."

Once he could show his FCC License, CIE graduate Calvin Smith of Salinas, California, landed the mobile phone job he'd been after for over a year.

Mail Card for Two Free Books

Want to know more? The postpaid reply card bound-in here will bring you free copies of our school catalog describing opportunities in electronics, our teaching methods, and our courses, together with our special booklet, "How to Get a Commercial FCC License." If card has been removed, just mail the coupon at right.

THESE CIE MEN PASSED THE FCC LICENSE EXAM... NOW THEY HAVE GOOD JOBS

Matt Stuczynski,
Senior Transmitter
Operator, Radio
Station WBOE



"I give Cleveland Institute credit for my First Class Commercial FCC License. Even though I had only six weeks of high school algebra, CIE's AUTO-PROGRAMMED* lessons make electronics theory and fundamentals easy. I now have a good job in studio operation, transmitting, proof of performance, equipment servicing. Believe me, CIE lives up to its promises."

Chuck Hawkins,
Chief Radio
Technician, Division
12, Ohio Dept.
of Highways



"My CIE Course enabled me to pass both the 2nd and 1st Class License Exams on my first attempt... I had no prior electronics training either. I'm now in charge of Division Communications. We service 119 mobile units and six base stations. It's an interesting, challenging and rewarding job. And incidentally, I got it through CIE's Job Placement Service."

ENROLL UNDER NEW G.I. BILL: All CIE courses are available under the new G.I. Bill. If you served on active duty since January 31, 1955, OR are in service now, check box on reply card for G.I. Bill information.

Cleveland Institute of Electronics
1776 E. 17th St., Cleveland, O. 44114

Please send me without cost or obligation:

Your 40-page book "How To Succeed In Electronics" describing the job opportunities in Electronics today, and how our courses can prepare me for them.

Your book on "How To Get A Commercial FCC License."

I am especially interested in:

- | | |
|--|--|
| <input type="checkbox"/> Electronics Technology | <input type="checkbox"/> Electronic Communications |
| <input type="checkbox"/> Broadcast Engineering | <input type="checkbox"/> Industrial Electronics |
| <input type="checkbox"/> First Class FCC License | <input type="checkbox"/> Electronics Engineering |

Name _____

(PLEASE PRINT)

Address _____

City _____

State _____ Zip _____ Age _____

Check here for G.I. Bill information

EW-69

2 NEW CIE CAREER COURSES

1. BROADCAST (Radio and TV) ENGINEERING... now includes Video Systems, Monitors, FM Stereo Multiplex, Color Transmitter Operation and CATV.

2. ELECTRONICS ENGINEERING... covers steady-state and transient network theory, solid state physics and circuitry, pulse techniques, computer logic and mathematics through calculus. A college-level course for men already working in Electronics.

CIE Cleveland Institute of Electronics
1776 East 17th Street, Cleveland, Ohio 44114

CIRCLE NO. 143 ON READER SERVICE CARD

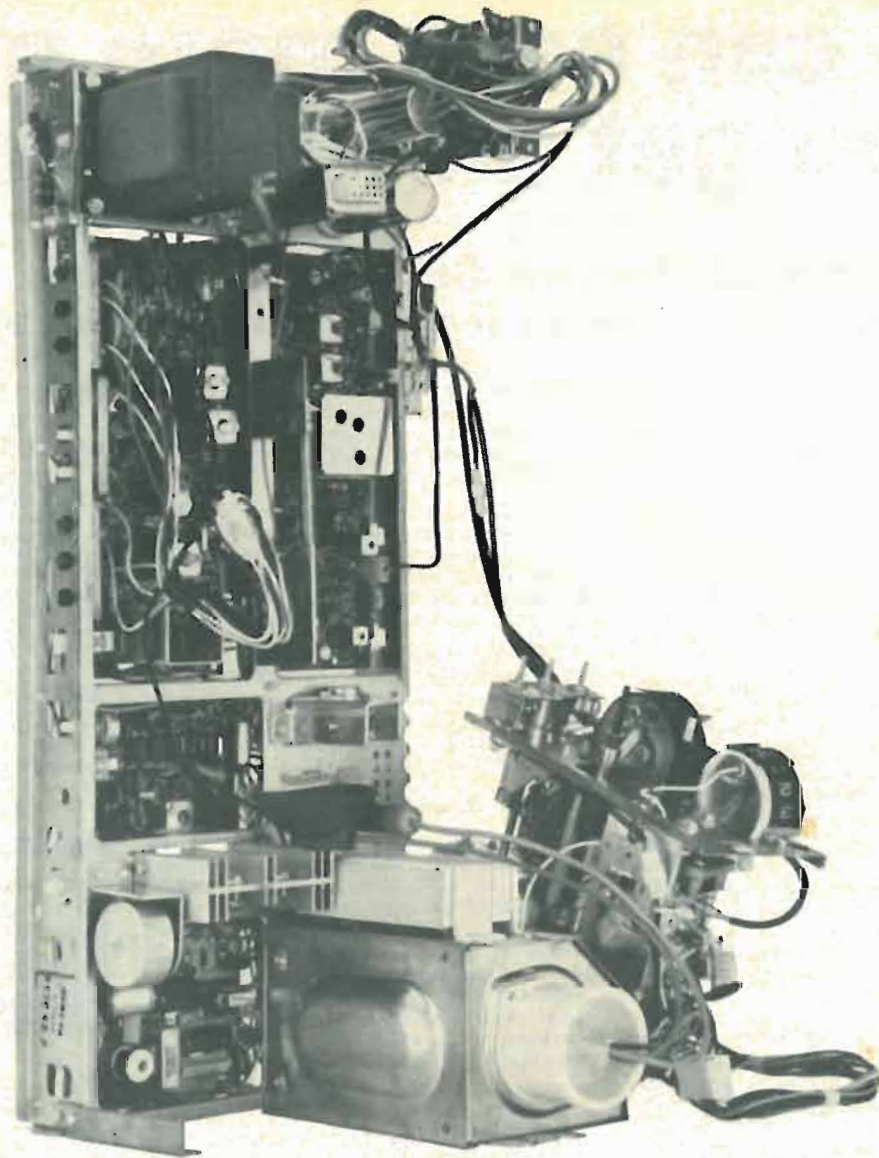

There's more here than meets the eye.

What you are looking at is RCA's solid-state* color chassis—the CTC-40.

A whole lot went into that chassis. Like fifteen years of technical research. Pioneering in the development of Solid State. And the backing of a national workshop program like nobody else's.

That's where you come in.

We've written a technical manual on the CTC-40 especially for Electronic Service Technicians. It has color

diagrams, pictures, and everything there is to know about our CTC-40.

You can buy it from your RCA Consumer Electronics Distributor, but there's a better way.

Attend the next RCA Consumer Electronics Distributor CTC-40 Workshop and get the manual free. Our distributor can tell you when it will be held next in your area. See you there.

*one tube rectifier



RCA



NEWS HIGHLIGHTS

What's New Around?

Looks like drudgery normally associated with office routines is about to draw last breath. *Sony Corp. of America* has come out with low-cost, programmable, electronic desk-calculator (ICC-2500W) that handles all invoicing, payroll, cost analysis, and other office routines with ease. Impressive features are its nine memories and simplicity of programming format. Average secretary can program calculator up to 111 program steps and visually check each program on panel display. . . . Housewife hasn't been forgotten either. According to *Neiman-Marcus* catalogue, *Honeywell* is offering a household minicomputer for the woman who doesn't have everything (except an affluent husband). Computer can make hundreds of menu-recipe selections and be programmed to handle budgeting, checkbook balancing, and children's homework. Cost of minicomputer plus 2-week program course is \$10,600. . . . And for those with sensitive proboscises, *Honeywell* has introduced a "Scentrol System" control for ridding home of unpleasant odors. Resembling portable radio, it can be mounted on a wall or installed in the ductwork of a central heating unit. When turned on, a fan is activated that disperses an odor counteractant that chemically alters odor particles to make them odorless. Slight trace of counteractant is left in air. Unit will retail for \$49.95, plus installation, and four-ounce bottle of counteractant, available in either mint, orange blossom, floral bouquet, or mountain air, and good for three months, will cost \$6. . . . Plastic wood? "Only the carpenter knows." Pressured by high costs and shortages of furniture hardwood and skilled wood-craftsmen, *General Electric Co.* recently announced development of "Acoustiform" material that "looks like wood, feels like wood, sounds like wood, and even smells like wood." Shapes, textures, and finishes with product are unlimited and desirable physical and acoustical properties make it ideal for console cabinets.

Information Retrieval

Mohammed didn't go to the mountain so the mountain came to Mohammed. To disseminate latest medical information to doctors unable to find time to keep abreast of their profession, the University of Missouri Medical Center has installed 13 medical-lecture playback machines, connected to regular telephone networks, that contain 500 tape-recorded talks on the latest and most significant medical subjects. During out-of-office hours or in emergency situations, doctors can now bring themselves medically up-to-date by simple spin of telephone dial. Plan is to increase number of taped lectures from 500 to a maximum of 5000.

Shades of 1984

Now even fish are "bugged." Commuting habits of skip-jack tuna in Hawaiian waters are sonically determined by force-feeding three-inch-long by one-inch-in-diameter transmitters powered by aspirin-size *Mallory* batteries to individual fish in schools. The Department of the Interior's Bureau of Commercial Fisheries has been conducting these operations in an attempt to increase the harvest yield of this valuable food-fish from 5000 tons to a potential of hundreds of thousands of tons.

Color Coding Goes 3-D

After years of intensive studies the Electronic Industries

Association (EIA), in conjunction with groups associated with industry and government, has devised a new and more definitive color-code standard for identifying electronic and electrical components. Replacing the two-dimensional (hue and value) system of defining colors with a three-dimensional definition (hue, value, and chroma), the EIA hopes to insure the correct identification of electrical characteristics and functions of electronic products. To date, the American National Standards Institute has adopted these new color-code standards and optimistic reports indicate imminent acceptance by the National Electrical Manufacturer's Association and the Department of Defense.

God Helps Those. . . .

The first medical training program, called "Home Hemodialysis Training" has been made available to those suffering with malfunctioning kidneys. Hemodialysis is a method of purifying patient's blood by circulation through an artificial kidney. Realizing the limited number of successful kidney transplants, crowded hospitals, and prohibitive cost of hospital-performed hemodialysis, scientists at *Autonetics, Div. of North American Rockwell Corp.*, in cooperation with leading kidney specialists, have developed an audiovisual program to train kidney patients and companions (wife, husband, etc.) how to perform hemodialysis with kidney machines installed at home. Medical training programs of this type, geared for the average layman, and conducted under the auspices of recognized medical facilities could hopefully reduce the number of needless deaths that occur each year.

Engineering Know-how

The 20th annual National Engineers Week, based on theme "Engineering . . . Environmental Design for the 1970's" will be held Feb. 22-28, 1970. This "Week" and extreme urgency of its theme will be publicly endorsed by President Nixon and most state governors. Some 535 local chapters of the National Society of Professional Engineers will emphasize to engineering community the role they must assume to protect and preserve our environment from the poisons that man continuously spews forth in his wild and blind rush to achieve a technological Utopia. News media will dramatize need for government-sponsored crash program for 70's, similar to that proposed and successfully completed for placing a man on the moon. The hope is to reverse the processes that are rapidly depleting our environment.

Radio Patriarch Honored

Prior to the NEW (National Electronics Week) show to be held in Chicago May 11-13 a testimonial dinner in honor of Sam Poncher, a veteran of 40 years in the electronics industry and present chairman of *Newark Electronics, Inc.*, will take place at the Hilton Hotel on Saturday evening, May 9, 1970. Looking back over his long and active career which started with his acquisition of the *Newark Electronics Co.* in 1930 (now division of *Premier Industrial Corp.*), president of Electronic Industry Show Corp. (1960-61), president of National Electronic Distributors Association (1964-65) and later as chairman of the board (1965-66), and up until last year president of Radio Oldtimers, leaves no question in anyone's mind as to why the Williford Ballroom of the Hilton Hotel is expected to be filled to capacity. ▲

THESE TWO MAKE BEAUTIFUL MUSIC TOGETHER

When you hear them together,
you will know why they were
made for each other . . .

KENWOOD's sophisticated twosome is made for lovers—music lovers. The KT-7000 FM/AM Tuner and the KA-6000 Stereo Amplifier reflect the ultimate in creative audio engineering.



(TOP) KENWOOD KT-7000 • FET • IC • XTAL • SOLID STATE • FM/AM • AUTOMATIC STEREO TUNER . . . \$249.95*

(BOTTOM) KENWOOD KA-6000 • SOLID STATE • 180-WATT • STEREO AMPLIFIER . . . \$249.95*

*includes cabinet

the sound approach to quality



KENWOOD

15711 S. Broadway, Gardena, Calif. 90247
69-41 Calamus Ave., Woodside, N.Y. 11377
Exclusive Canadian Distr.—Perfect Mfg. & Supplies Corp. Ltd.

CIRCLE NO. 126 ON READER SERVICE CARD

TELEVISION: 20 Years From Now

By FOREST H. BELT / Contributing Editor

Two decades can change a world. At the doorway to the 1990's what will U.S. television be like? Will TV still be free? Will telecasting be over the air or on cable? What about programming and TV servicing in the future? Here are some of the answers from leaders in the industry.

TODAY, at the threshold of the 1970's, a giant specter of change looms over the television-broadcasting industry in this country. Its nature and extent seem sure to penetrate every corner of our living—even into situations barely touched by TV today. As the next 20 years unroll, some changes will be startling, some exciting, others perplexing; a lot of them will provoke resistance and conflict in one quarter or another.

The overwhelming question right now, in 1970, is: *Will national telecasting in 1990 be over the air or through cables?* A controversy has been building up around that question for nearly 10 years.

Cable television (formerly called *community antenna television* or CATV) has grown phenomenally in that time. Some watched it, some ignored it; some hid their heads in the sand and hoped it wasn't real, some fought it, some joined it, some hampered it; but certainly nothing stopped it. And now the question is, how far can it go?

The story of CATV is marked by controversy. In the 1950's, systems were quietly installed in mountain communities where normal TV reception was poor or impossible. They offered a unique community service.

Then around 1960 someone realized not all towns getting community antennas were isolated. A closer look revealed why: there's a chunk of money to be made in CATV. People will pay to receive more stations and stronger signals than a rooftop antenna can provide.

Antenna manufacturers set out to stop the cable systems from setting up in towns where some TV could be received. They wasted most of their efforts. CATV went wherever it wanted to.

The dollars attracted large companies. Early CATV systems were "mom and pop" operations. But wheeling and dealing soon spawned the CATV conglomerates that are still growing today.

AUTHOR'S NOTE: People in all sorts of vocations and avocations, in and out of the TV field, show concern for the future of TV. The more articulate of them willingly shared their views of the next 20 years. Naturally, they didn't always agree.

Several, particularly in high circles within the industry, carefully avoided meaningful commitment. Some we talked with obviously prefer the status quo; others like change, but merely for its own sake. Some didn't seem willing or able to face unwanted possibilities. Discussions with a few seemed hindered by "keep it for

ourselves" secrecy. One slogan we heard paraphrased fairly often was "let the market (in this case, the viewing public) decide," as if dollars alone are arbiters of what is good or bad.

Futurology leans heavily on present and past. You examine existing technology and trends, compare them with history, and then extrapolate your own assessment of what's to come. That's how this analysis of 20-years-hence was prepared. The conclusions are my own, seasoned by opinion from the editors of this publication and from the field's top thinkers and doers.

More opposition sprang up. Broadcasters, suddenly fearful for their own future status, raised a ruckus. They went all the way to Washington and the Government got into the melee. Eventually, not long ago, the Federal Communications Commission asserted its right to regulate cable-TV systems like it does broadcasting.

At broadcaster instigation, copyright owners decided they would try to collect royalties from cable operators. They failed.

Cable-TV has been held back only vaguely in any direction. Much heat today centers around what opponents call broken promises by cable owners. Here are some examples:

Before 1960, CATV people insisted their only purpose was to serve communities that were without TV service. Their purpose has since been amended; they serve communities that don't have *adequate* TV service. The term "adequate" gets loose interpretation. New York and Los

“The wired country is a strong possibility. Once it's really started, broadcasters themselves will switch, or else become suppliers of mass-appeal entertainment. The cable owners themselves for years had no idea of the extent to which the public was going to accept—even demand—the many services that have developed in CATV.”

**Frederick W. Ford/President,
National Cable Television Association**

Angeles, both with plenty of local stations, are getting cable systems "because of reception problems." The most-quoted excuse today for cable expansion is "demand of the market."

In 1964, cable spokesmen insisted they had no intention of originating programs. They would only rebroadcast signals. Within the year some cable systems were carrying weather reports and news, and later, movies. Thirty percent of all cable systems now have their own programs. Proposed FCC rules will *require* them to include original programming.

One justification of the monthly cable charge was that it frees programming from the constraints of commercials. But there have been commercials on cable systems for years now; and there's every assurance they'll be a part of all cable programming.

It's no wonder, then, that very few expect any other "taboos" to hold. Outsiders worry about: Extra charges (pay-TV) for special-interest movies or sports events. New-set sales by cable companies. Set-servicing charges added right into the monthly cable charge. Set leasing with captive servicing. Nothing has barred cable operators from other activities they decided on; there's no reason to believe they won't get into these too, whenever they're ready.

Why not? The income potential is there. Cable is a ready medium for promoting whatever package an imaginative entrepreneur dreams up. And cable men are imaginative.

The conclusion seems inescapable. Television in 1990, barring drastic unforeseen and powerful blocks to cable systems, will be wired and nationwide.

An official of the National Cable Television Association (NCTA) predicts 90% of U.S. television homes will be wired for cable within *10 years*, let alone 20 years. Even allowing for optimism of industry politics, that estimate seems exaggerated.

But accurate or not, this prediction reflects the intention of the cable-TV industry. What's more, enthusiasm and power are not the only reasons a TV-wired nation is likely. Other powerful forces are influencing a shift from air TV to wire TV.

One is a clamor after more spectrum for public-safety radio services, and for radios in land, sea, and air vehicles. Needs multiply faster than technical improvements. One so-

lution is to put TV on r.f. cables, freeing the television spectrum for operations that can't be tied down to a wire.

There's another good reason wire TV looks like the way

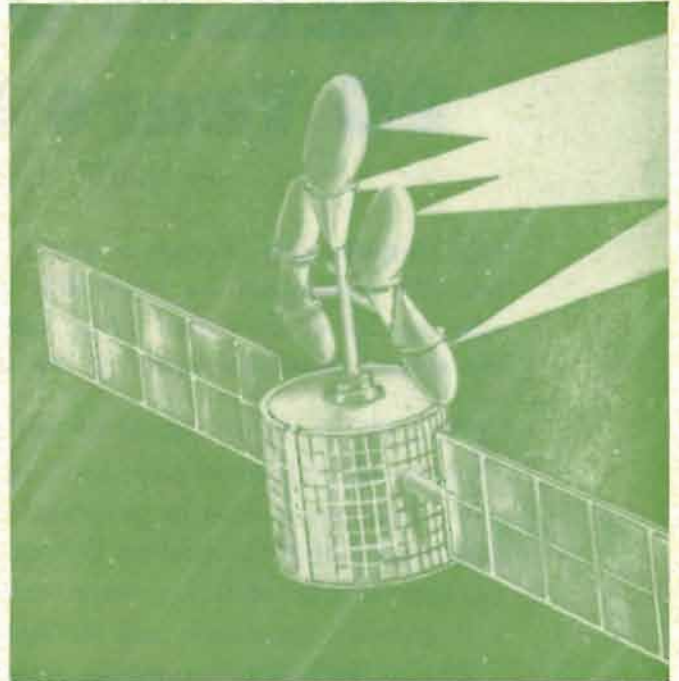

An advanced antenna system for direct broadcast of TV programs from an orbiting satellite to home receivers is being designed today for NASA by Sylvania. By concentrating programming to small areas of the earth and transmitting about 100 times the power of present satellites, the antenna system will provide signals strong enough for reception by modified home equipment. A two-foot diameter antenna and small converter, like the early u.h.f. TV converters, will be required.

to go. A cable system, even a large contiguous one, is easily divided into small local segments. This offers a medium for community self-expression that may be paramount to the social and cultural ferment in our cities and subcities. Multiple channels give a cable operator flexibility for minority interests without every program having to "pay." Air TV, as it exists, can't pinpoint multiple audiences like that, either technically or economically.

We hear those who contend an all-wire system is out of the question. They offer various reasons.

One fellow says, "The broadcasters won't let it happen. They're too powerful."

Don't kid yourself. Antenna makers and broadcasters both tried. Neither was more than an annoyance to cable progress. Several broadcasters (and at least two antenna firms) gave up trying to lick the cable operators and quietly joined them. Half of all cable systems now are owned partly by broadcasters; 30% are *controlled* by companies that also own broadcast stations. Why would broadcasters scuttle cable-TV at this stage?

"Several Congressmen own broadcast properties. They won't let cable take over."

Wishful thinking. You can't pin down what most Congressmen own. But it's an even gamble that just as many own cable systems as own broadcast stations.

“I'm skeptical about direct satellite broadcasting, because of cost. It might be a way to serve rural areas through ground stations. The key (would be) to accommodate satellites to local broadcasting.”

**Robert E. Lee/Commissioner,
Federal Communications Commission**



"The networks. . ."

Forget it. Networks supply programs for distribution to the viewing public. Whether by air TV or cable, outlets won't affect their profit sheets. There are indications that cable may *enhance* profits. *Columbia Broadcasting System* already has bought a couple dozen cable systems in the U.S. and Canada; they're shrewdly hedging their bets.

"The Federal Communications Commission. . ."

Yes, the FCC has put some brakes on cable recently. But the FCC is highly vulnerable to the vagaries of politics. Its attitude today doesn't mean much four years from now—nor twenty.

Actually, the most valid FCC concern is over "concentration of media control." If a market has nine TV stations, they're owned and controlled by nine different companies. But a cable system, even with 20 channels, is in the hands of one company. A market as large as New York City has been divided up so at least four cable companies are involved. But smaller markets won't be. Here's a legitimate danger to deal with. A cable system under biased control would be a powerful propaganda machine.

One answer to this is a common-carrier concept. The cable operator is permitted only one channel for his own use. Whatever other channels are not carrying "network" or educational telecasts must be leased to non-owner cablecasters for their own programs. A whole channel could be leased, or merely time on a channel.

From what we can make out, only the public has any

“The leasing idea isn't impossible. It is already done with hotels, motels, and hospitals. There will definitely be changes in the means of getting instruments into the hands of the consumer, but I don't think they'll be that drastic.”

**B.S. Durant/former Chairman,
RCA Sales Corp.**

power to stop cable-TV. If viewers refuse to pay, no cable-TV.

But don't count too heavily on that happening. As limited as cable-TV offerings are today by comparison with what's in store, subscribers seem surprisingly ready to accept it. It's common for 40 to 50 percent of the TV homes in a wired community to sign up right away for installations. Viewers even go out and buy new TV sets—especially color—to take advantage of the numerous and (ostensibly) better signals.

We can't agree with the doubters. Good or bad, right or wrong, the television wave of the future looks like cable.

What happens 20 years from now depends a lot on political and economic factors. Predicting technical changes is easy by comparison.

The population of the U.S. by 1990 will have grown to about 300 million. Barring economic or political disaster,

the gross national product should have reached \$2 trillion. More than half the families in the country will be earning nearly \$20,000 a year (based on today's dollars). Everyone will have more leisure time, and there'll be more cultural and educational interests than there are today.

The wire-TV system will be a nationwide grid of coaxial cables, made up of regional systems. A cable will be able to carry 50 channels or so of TV. A few giant companies will own the big regionals; but there'll be a few hundred independent operators, mostly with small semi-rural systems that aren't economical for the biggies. These little systems will tie into the big ones for many of their programs.

Who will these giants be? Among the networks, *CBS* is already a cable company. Top cable operators are growing

“Discussing the future of broadcasting is a somewhat sensitive undertaking. Any projections would be inappropriate.”

**Vincent T. Wasilewski/President,
National Association of Broadcasters**

fast even now, merging small companies and starting new ones. Phone companies like the looks of cable too; *Continental Telephone* in St. Louis and *United Utilities* in Kansas City (Mo.) each own cable systems with nearly 50,000 subscribers. Publishers, looking for new ways to beat printing costs, are eying cable to distribute news, pictures, and other information; *Time, Inc.* has \$15 million invested in cable operations so far.

Watch for cable giants to evolve on the order of communications monopolies like *American Telephone and Telegraph, et al.* When that happens, you can look for even more serious effects than those we'll be telling you about later.

Regional or local systems will probably carry no more than 25 channels of television.

There'll be at least six national entertainment networks. Their programs may be fed to regional systems by s.h.f. satellites or by network cables. They'll offer a large variety of entertainment. What's carried at different times of the

THE TV SERVICE TECHNICIAN OF THE FUTURE

"The independent service technician won't exist under this system. He will, instead, be an important member of the cable organization. He'll be well-trained, respected, adequately paid.

"Many headaches of consumer servicing will be gone. The technician will still have customer-relations problems, but with much sting taken out. After all, with no repair bill to pay, a customer has a different attitude. If a set is a tough dog, the technician just leaves another or replaces whatever module tests bad. In the shop, sets will be reconditioned, updated with newer modules, and kept like new.

"Whereas today there are some 100,000 technicians, many poorly paid, by 1990 there will be 200,000, all well paid. Technicians who haven't kept up with technology and techniques will have long before left the field. The top-notch type of guy who becomes a successful shop owner now will then be service manager for a cable company—or he may be the owner of a small cable operation somewhere."

day will be determined by audience research, much as it is today. The six entertainment channels will still carry commercials.

There will be a national and international news channel, maybe fed alternately by two or three news services. This channel will operate 24 hours a day. A separate news chan-

“I feel it would not be appropriate to discuss (CATV, pay-TV, and domestic satellite services for broadcasters) for publication, at this time.”

**Leonard H. Goldenson/President,
American Broadcasting Companies, Inc.**

nel will be reserved for local interest—much like a town newspaper. The local news channel will also carry time, weather, and special bulletins, but no commercials.

At least six channels will be reserved for education. Four of them will be regularly programmed by a national education network. One may handle adult self-improvement, and another, professional studies. Or the six may carry school curricula by day and adult courses by night. Whether at home or in “resource” rooms at school, children will get a significant part of their instruction over these education channels.

Five channels will carry cultural cablecasts. Local schools, drama groups, churches, civic clubs, and libraries will use two of these, probably at no cost. Two will carry cultural telecasts generated by national groups like the Corporation for Public Broadcasting, the Metropolitan Opera, the Museum of Modern Art, and similar groups. One will be for cultural telecasts from overseas *via* satellite.

One channel will be for political activity and debate—with time divided up among national, state, local, or minority politics, or any far-out political philosophy. The years of political spoon-feeding we live in now will have created a strong desire to have all sides of major issues aired, no matter who holds a view or how little others may agree with it.

Of the remaining five channels, one will be for the cable company to program as it wishes, with commercials if it pleases; probably, fare on this channel will be largely local entertainment.

The other four will be leased to cablecasters who don't own systems; this is the common-carrier concept mentioned earlier. Users of these channels may offer entertainment, education, or whatever, with or without commercials. They

may even be used for pay-TV; a subscriber will pay a fee to the pay-TV operator for a descrambler to watch special programs.

Obviously, this has been an exercise in educated guesswork. Additional ways to use channels will develop, too. But you can surely begin to see why wire-TV is so likely to be the system by then.

About 80% of the U.S. population will live in the “top 100” television markets. That's where the concentration of cable systems will be. Another 10% will live in non-rural places that won't be hard to serve with cable.

But what about rural locales? Wire won't reach them economically. One cable-association executive suggests that Congress will pass an act resembling the Rural Electrification Act. (That's what finally brought electricity to virtually all the nation's rural areas.)

Here's a plausible alternative. By 1989, the two or three s.h.f. satellites will be technically sufficient to reach right into any home that has a suitable antenna and converter. They may already be feeding network TV to cable systems, as well as being used for education purposes. Instead of

“Cable, if left alone, will kill broadcasting as we know it today—especially pay-TV by cable, which is a direct and immediate threat to broadcast TV. But the FCC will prevent total wipeout, leaving at least the small markets for broadcasting.”

**Isaac S. Blonder/Chairman of the Board,
Blonder-Tongue Laboratories, Inc.**

buying cable service, rural viewers could spend their money on s.h.f. receiving gear. Even such curtailed service would be more than is available to them today.

One of the first casualties of tomorrow's television system may be today's way of distributing, merchandising, and maintaining television receivers. You can expect the giant companies to lease them to subscribers directly, maintenance included.

With today's rampant consumer complaints, the concept will be easy to sell. It won't necessarily be any better, actually, because ordinary people will still build, install, and repair the sets. But there are reasons it *could* be better. And the cable operator has a market that is psychologically ready.

The effect on manufacturers may be for the public good. There'll be fewer, and they'll build a limited number of standard models—some plain, some fancy. With repairs cutting into cable company profits, receiver quality will be top priority. Maintenance aids will be built in. Sets may cost more to build, but direct selling in huge lots will trim distribution and sales markups. Some giants may make their own sets. Consumer cost in the long run will be less—and for more dependable operation.

The independent service technician won't exist under this system. He will, instead, be an important member of the cable organization. He'll be well-trained, respected, adequately paid.

Many headaches of consumer servicing will be gone. The technician will still have customer-relations problems, but with much sting taken out. After all, with no repair bills to pay, a customer has a different attitude. If a set is a tough dog, the technician just leaves another or replaces whatever module tests bad. In the shop, sets will be reconditioned, updated with newer modules, and kept like new.

Whereas today there are some 100,000 technicians, many poorly paid, by 1989 there will be 200,000, all well paid. Technicians who haven't kept up with technology and techniques will have long since departed the field. The top-notch man who becomes a successful shop owner now will then be service manager for a cable company—or else he

A LOCAL 25-CHANNEL TV SYSTEM MAY PROVIDE:

- 6 National entertainment networks, with commercials
- 1 National and international news channel
- 1 Local news, time, and weather channel
- 6 Educational channels, including 4 on national networks
- 2 Local cultural channels
- 2 National cultural channels
- 1 International cultural channel
- 1 Political activity and debate channel
- 1 For use by cable company, for local entertainment
- 4 For lease to cablecasters, for pay-TV or other services

“The electronic box office (pay-TV) can deliver the products of the finest creative talents directly to the home more conveniently and more economically than any other method.”

**Joseph S. Wright/Chairman,
Zenith Radio Corp.**

may be the owner of a small cable operation somewhere.

To the viewer, who pays all the bills in the long run, the system described for 1990 will have countless advantages. Programs will be, if not better, at least more numerous and fit a broader range of tastes. Equipment will be more dependable and service more competent. Cost may well be no higher than it is today—perhaps even less. Rates will be tied to costs by Federal regulation, and there are many chances for substantial economies.

Whenever a writer ventures into electronics futurology, readers sooner or later expect some way-out technical predictions. This sort of thing has already been done over and over. Besides, the set makers like to surprise everyone. But, not to disappoint any readers who are interested, a few 1989 technical secrets can be revealed.

Twenty years is an awkward prediction cycle. TV is barely older than that. Yet, on the accelerating curve that traces electronic progress, 20 years of future bears little relation to 20 years of history. We shouldn't overcompensate, however.

Sets are the first thing most people ask about. They'll be big, and all color. They'll have thin screens, matrix-scanned. Size will be determined by viewing distance rather than by cost. New digital interlacing techniques will improve close-up viewing of large screens, within limits. A favorite size will be 3 by 4 feet.

Four-channel stereo television sound may be optional, to go with oversize screens. Three-dimensional television, though, will still be waiting for fiber-optic cables and laser-beam transmission. A few big local cable systems might offer this kind of service as a novelty, but it won't yet be part of the national wire system.

TV front-ends will have changed. The v.h.f. and u.h.f. TV bands will no longer have any significance. Much lower

frequencies will go better over the cable. Front-ends will be tuned by touch, probably with ten buttons on which you merely punch the numerals of whatever channel you want to watch. Tuning will be instant.

The cable will eventually carry all sorts of other services to and from your home. You've probably read about many of them. Not all of them will be in operation by 1989.

The huge school-age population will have made education top priority among these peripheral services. There won't be enough classroom space; some home instruction will be a necessity. But it won't be the insipid stuff that passes today for much of TV instruction.

Subliminal teaching lends itself handily to TV. Other high-speed programmed systems of teaching fit television formats. Pumping specific facts into a student's head can be

“We must look toward a day in which all usable frequencies will be crowded. When that happens, it would seem best to reserve radio transmission for those uses to which it is particularly adapted, such as communications with ships, airplanes, automobiles, and, in general, people on the move.”

**J.R. Pierce/Director of Research,
Communications Sciences,
Bell Telephone Labs**

done quickly then, leaving more time for teaching students to think and to put knowledge to work. Special technical gear will make these new education concepts work.

Yes, this is what you can expect the television industry to be like in 1990 . . . a mere 20 years from now. Of course, spokesmen in each segment of today's industry will have exceptions to take. But the louder they object, the less likely they are to hear the scratching finger that is writing on the wall. Every month, industry news heralds another step in the direction described. You'll recognize the trends if you watch for them.

Of course, you and the industry today can determine how true or how false these predictions prove. You have about 20 years to work out alternatives. ▲

WHERE CABLE-TV IS TODAY

Congress seems to be sitting on the issue of cable-TV expansion, evidently waiting for some kind of agreement among the various and powerful pressure groups that are involved with major issues. That isn't likely, but at least some compromises are expected before legislative action is undertaken. Major issues are:

Conditions under which cable can go into top-100 markets

Copyright and royalty payments

Pay-TV

Domestic-satellite policy

The Federal Communications Commission has laid down rules for cable-TV in top markets, but is willing to suspend them on application. Witness New York City and Los Angeles, which are getting cable systems. "Final" rulemaking is scheduled for December or early January. Final comments date is November 3rd.

Copyright legislation to affect all copyright law, but to finally include CATV, didn't get far at all in the 1969 session of Congress. It is in the works again for 1970 action,

but the outlook for passage is pessimistic. Maybe a watered-down, partial version will get through, but it is nigh impossible to guess its effect on cable operation. The National Cable Television Association expresses willingness of members to pay reasonable royalties, but Congress has to legislate to whom—and how much.

The FCC has approved over-the-air pay-TV. The approval is momentarily blocked by movie interests, in the courts. Meanwhile, however, subscription-TV principals are going ahead with plans. They are assured that, if the courts knock down the FCC decision, Congress will pass appropriate legislation. Pay-TV, insist its proponents, is inevitable.

At press time, no decision has been announced on domestic-satellite policy. Quite a bit hinges on the Intelsat negotiations now in progress. Educated guesswork says we'll have domestic satellites as we want them. FCC will then clear the way for satellite-to-home experiments. Hardware is already being put together. Besides, technological "fallout" from our space programs promises to cut the cost of lofting and operating communications satellites. And advanced communications capabilities seem to make domestic-TV satellites a foregone conclusion.

RECENT DEVELOPMENTS IN ELECTRONICS

Giant Camera for Multilayer PC Boards. (Top left) What is believed to be the world's largest camera used in the electronic industry has just been installed to help manufacture precision multilayer printed-circuit boards. The camera weighs six tons and is 28 feet long. It has an image accuracy of one-tenth of one mil (0.0001"). The copy board for photographing the printed circuit layout image is 60 inches by 80 inches. To eliminate external vibrations which would affect the image accuracy, the camera is mounted on a concrete pad measuring 38 feet by 17 feet by 6 feet deep requiring 285 tons of concrete. The atmosphere in the camera room is controlled to within 2 degrees and the relative humidity is maintained within 2 percent. A lighting box containing 32 fluorescent tubes is utilized to back-light the copy board. The camera is in the new west-coast plant of Cinch-Graphik.

Satellite Earth Station for Canadian TV. (Center) A new Canadian satellite earth station is being constructed at Ottawa. This experimental station will be used to test and evaluate a technique of receiving color-television signals in remote areas of Canada. Operating in the 4000-MHz range, the new station will be used with that nation's domestic satellite, due to be launched in 1972. There is considerable interest in the satellite in the United States. At a recent Audio Engineering Society banquet in New York, a domestic-satellite system was proposed by Dr. Frank Stanton, head of CBS, as a supplement to our TV network facilities. The owner and operator of these facilities, AT&T, subsequently expressed interest in participating in such a system, which would be able to provide considerably expanded TV programming in many sections of the country. Signals from a domestic satellite would be received by elaborate ground stations, possibly using antennas of the type shown. From these ground stations, the signals could be distributed to homes in the area either by radio or cable. Other proposals have been made to use domestic satellites to transmit TV signals directly to home receivers. The dish shown is at Northern Electric Labs.

Surveillance-Radar Radomes Being Tested. (Below left) The six scale-model radomes on the ground are among the configurations being tested for the U.S. Air Force's Airborne Warning and Control System (AWACS). The radomes of various shapes were used in trade-off studies of radome effect on radar and aircraft performance. The new surveillance radar, capable of "looking down" and separating moving objects from ground clutter, will be carried by the aircraft in a 30-foot diameter externally mounted radome. The shapes of the six radomes on the ground are, from left to right, symmetrical biconvex, symmetrical ellipsoid, two cambered ellipsoid variations, an aerodynamically tailored asymmetric, and cambered ellipsoid. Mounted over the scale-model radar on the 1/7th scale AWACS 707 jet aircraft is a symmetrical ellipsoid radome. The tests are being conducted at Boeing's 5000-foot-long antenna range located near Kent, Washington. The company is competing for the prime military contract.

Air Traffic Control Radar Shows Digits. (Top right) Another item from Ottawa this month concerns the evaluation at Canada's Dept. of Transport Air Traffic Control Center of the newest in ATC systems. The display shows the ground controller the location, identification, and altitude of planes by use of digits directly on the radar scope. Employing ground interrogators and airborne transponders built by AIL, the display should reduce the communications workload of pilots and controllers. The company has just been awarded a \$40-million contract for over 300 interrogators producing such a display for military air terminals in the U.S. and abroad.

Pipes for Electronic Organ. (Center) The world's largest installation of pipes for an electronic organ has been made at the Cathedral of Tomorrow in Cuyahoga Falls, Ohio. Three groupings of pipes are used with a Conn organ console in order to provide coverage in the 5000-person sanctuary. Tones are first shaped by the organ's voicing circuits and then amplified. Amplifier outputs are then fed to loudspeakers which radiate their sound into the pipes. Unlike acoustic pipes, these pipes do not require tuning or the use of shuttered expression chambers. Main organ pipe sets and speakers handle 400 watts of music power each; echo pipes handle 200 W.

Thick-Film Hybrid IC's for Car Radios. (Below left) A number of thick-film hybrid IC modules were used in 1969 car radios and the new 1970 models will be using even more. The modules use ceramic substrates on which are screen-printed thick-film conductors, resistors, capacitors, and crossover insulators. Discrete components are then attached to the IC chip. Three modules are available for use in AM radios: an r.f. module, i.f. module, and a.f. module. For FM sets there is an amplifier-limiter module and a stereo demodulator. The thick-film circuitry was fabricated by Du Pont, while the modules are in use in some Delco automobile receivers.

Thin-Film Spiral Inductor. (Below right) In addition to thick-film products shown at the left, thin-film products are in the news this month too. The spiral inductor shown here is one of a series of new miniature coils being sold by Motorola for use in hybrid IC's. The coils have "Q's" of 20 to 30, inductances from 28 to 230 nanohenrys, and self-resonant frequencies from 0.7 to 1.8 GHz. The inductors, fabricated on a 0.01-in. thick alumina substrate, use a proprietary conductor and special photoresist technique that make possible conductor thicknesses of 0.3 mil. Such thicker conductors have lower resistance, hence higher "Q." These chip inductors are the first products in a line of encapsulated thin-film passive parts. Resistors and capacitors will be available later.

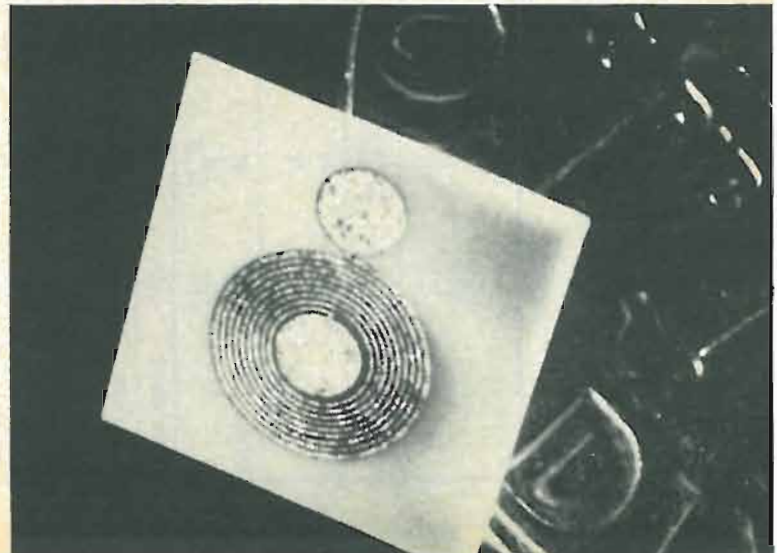
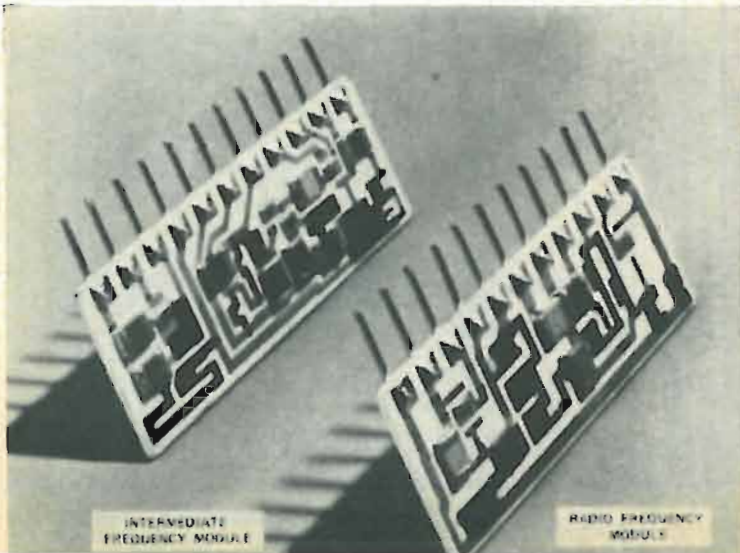
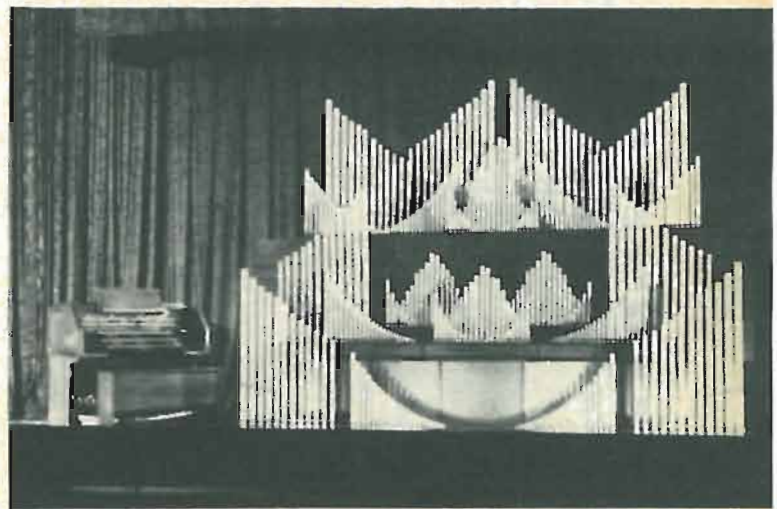

INTERMEDIATE FREQUENCY MODULE

RADIO FREQUENCY MODULE

DIRECTORY OF 1970 COLOR-TV CHASSIS

By FOREST H. BELT
Contributing Editor

MFR	CHASSIS	CRT1 SIZE	DESIGN ²	IC's	FINE-TUNE AID	V.H.F.3 TUNER	REMOTE CONTROL	QUICK WARMUP	DEGAUSSING ⁴	H.V. REG	NO.24 VIDEO I.F.'s	NO.24 CHROMA B'PASS	TYPE5 DEMOD	COLOR DIFF AMPS	HEATERS	
ADMIRAL	6H10 12H10 18, 20 19H10 15H10 —K10's 11H12	18, 20 18, 20 20 23 23 12, 14, 16 23	tube tube tube tube 7/252 tube		a.f.t. a.f.t. a.f.t.	tube tube tube xstr tube	7-function 7-function 7-function	Instant Play Instant Play Instant Play	auto auto auto auto auto	pulse pulse pulse pulse shunt	3 3 3 3 3X 3	2 2 2 2 2X 2	X-Z hi X-Z hi X-Z hi X-Z hi R-Y, B-Y X X-Z hi		parallel parallel parallel parallel series parallel	
AMBASSADOR (Allied Stores)	2907A 2914A	See JVC-Nivico 151 See JVC-Nivico 7208														
ANDREA	VXC-325-1 to 6 VXC-325-7	23 23	hybrid hybrid	sound sect, remote sound sect, remote	eye, meter, or a.f.t.	tube tube ⁶	7-function 7-function	auto auto	n.a. n.a.	n.a. n.a.	3 3	2 2	X-Z lo X-Z lo	yes yes	n.a. n.a.	
ARVIN	60K— 70K— 78K— 80K—	15 20 18 20, 23	tube tube tube tube	sound sect.	light	tube tube tube		auto auto ¹³ auto ¹³ auto	n.a.	n.a.	3 3 3 3	2 2 2 1	X-Z lo X-Z lo X-Z lo X-Z lo	yes series yes series parallel	19 series series series parallel	
BELL & HOWELL	2945	20	hybrid			tube		n.a.	n.a.	n.a.	n.a.	n.a.	n.a.	n.a.	n.a.	parallel
BROADMOOR	6911C 6915C 6918C	11 15 18	9/252 9/25 9/25	sound i.f. a.f.t. a.f.t. a.f.t.	a.f.t. a.f.t. a.f.t.	xstr xstr xstr	yes yes yes	auto auto auto	auto auto auto	pulse pulse pulse	3 3 3	2 2 2	X-Z X X-Z X X-Z X	yes series series	series series series	
CLAIRTONE	MSS 712 ¹		xstr ²⁰	four		xstr		n.a.	n.a.	n.a.	n.a.	n.a.	n.a.	n.a.	n.a.	n.a.
CONAR (kit) (N.R.I.)	600	18	tube			tube		none	none	pulse	2	1	R-Y, B-Y	G only	series	
CRAIG	6303-04	15, 18	tube		a.f.t.	tube	yes	auto	auto	n.a.	n.a.	n.a.	n.a.	n.a.	series	
DELMONICO	See JVC-Nivico															
ELECTROHOME	C6 C8	18, 20, 23 23	hybrid tube		a.f.t. ⁷ a.f.t.	tube varactor ⁶	wired	auto auto	auto auto	pulse pulse	3 3	2 2	R-Y, B-Y R-Y, B-Y	yes yes	series parallel	
ETHAN ALLAN (Baumritter)	See General Electric KE series															
GENERAL ELECTRIC	G1 G1 H3 KE	18, 19, 20 14 10 18, 20, 23	12/112 tube tube tube 16/52		a.f.t. a.f.t.	tube tube tube tube		auto auto manual auto	auto auto auto	pulse pulse pulse shunt	3 3 3 3	1 1 1 1	X-Z D X-Z D X-Z D X-Z D	yes series yes series parallel	series series series parallel	
HEATH (kit)	GR-180 GR-227 GR-295 GR-481 GR-581 GR-681	18 20 23 18 20 23	tube tube tube tube tube tube	a.f.t. a.f.t. a.f.t. a.f.t., remote a.f.t., remote	a.f.t. a.f.t. a.f.t. a.f.t.	tube tube tube tube tube	6-function 6-function 6-function 6-function	auto auto auto auto auto	auto auto auto auto auto	shunt shunt shunt shunt shunt	3 3 3 3 3	2 2 2 2 2	X-Z lo X-Z lo X-Z lo X-Z lo X-Z lo	yes yes yes yes yes	parallel parallel parallel parallel parallel	
HITACHI	CNA-25T CWA-200 CFA-450	18 12 14	hybrid xstr xstr	a.f.t.	a.f.t.	tube xstr xstr	yes	auto auto auto	auto auto auto	shunt 22 pulse	3 4X n.a.	1 2X n.a.	X-Z lo R-G-B D n.a.	yes 12 n.a.	series	
HOFFMAN	leaving color-TV business															
JVC-NIVICO	151 7208 7408 7438	18 14 18 18	tube 10/282 tube 12/272 12/282		a.f.t.	tube tube tube tube		auto auto auto auto ¹³	auto auto auto auto	shunt shunt shunt shunt	3 3 3 3	2 2 2 2	X-Z D X-Z D X-Z D X-Z D	yes yes yes yes	n.a. n.a. n.a. n.a.	
MAGNAVOX	T934 T936 T939 T94010 T947	19R ⁹ 14 18, 20 23 11	tube 9/202 tube tube 12/152	sound sound	a.f.t. a.f.t.	tube xstr tube tube xstr	Quick-Picture Quick-Picture Quick-Picture	auto auto auto auto	auto auto auto auto	pulse pulse pulse shunt pulse	3 3X 3 3 4	1 3X 1 1 2	R-Y, B-Y R-Y, B-Y R-Y, B-Y X-Z lo R-Y, B-Y	G only G only G only yes G only	n.a. series n.a. parallel parallel	

MOTOROLA	TS-91523 TS-921 TS-924 TS-930	20, 23 18, 19, 23 14 16	xstr tube tube hybrid	sound sect.	FTI/FTL ¹ FTI/FTL	xstr tube tube tube	7-function 4-function	yes	auto auto ¹³ manual manual	pulse pulse pulse pulse	3 3 3 3	R-B-G-D X-Z hi X-Z D X-Z lo	yes ^{1,2} yes yes yes	parallel series series n.a.
OLYMPIC	CTC-30, 31 CT911 CT400	22, 23 18 14	tube tube tube	eye	Rapid-On	tube tube tube	shunt, pulse pulse ¹⁰	3 3 3	auto auto auto	shunt, pulse shunt pulse ¹⁰	3 3 3	X-Z lo X-Z hi X-Z hi	yes yes yes	parallel series series
PACKARD-BELL	98C21 98C22 CO-372 CO-522-524 CO-622 CO-634	23 23 12 15 18 18	11/182 11/182 10/252 10/242 tube tube	{ CW osc. sound } sect.	a.f.t. a.f.t.	tube xstr xstr tube	optional VHF only 3-function	Instant Action Instant Action	manual manual manual manual auto ¹³	shunt shunt pulse pulse pulse	3X 3X 3 3 3 3	R-Y, B-Y X R-Y, B-Y X X-Z D X-Z D X-Z lo X-Z lo	yes yes 14 14 14 yes yes yes yes yes n.a.	parallel parallel n.a. n.a. n.a. series
PANASONIC	CT-23P CT-24W CT-64P CT-65D CT-93P CT-94T CT-95D CT-991	12 12 15 15 19 19 19 9	10/472 10/462 10/582 10/602 tube tube tube xstr	a.f.t. a.f.t.	yes yes yes yes yes yes yes	xstr xstr xstr tube tube tube xstr	5-function 7-function 8-function 10-function	yes yes yes yes	auto auto auto auto auto auto auto	pulse pulse pulse pulse pulse pulse pulse pulse	3 3 3 3 3 3 3 3	X-Z D X-Z D X-Z D X-Z D X-Z lo X-Z lo X-Z lo n.a.	14 14 14 yes yes yes yes yes n.a.	n.a. n.a. n.a. n.a. n.a. n.a. n.a.
PHILCO-FORD	19FT60 19KT40 20KT40 20KT41 200T87 200T88 200T89 200T90	14 18 18 18 23 23 23 23	8/252 8/252 8/252 8/252 16/122 16/122 16/122 16/122	CW osc CW osc CW osc	eye eye	xstr xstr xstr xstr xstr xstr	5-function 7-function	yes yes	auto auto auto auto auto auto	pulse pulse pulse pulse pulse pulse	3X 3X 3X 3X 3X 3X	X-Z X X-Z X X-Z X X-Z X X-Z lo X-Z lo X-Z lo	yes yes yes yes yes yes yes yes	parallel parallel parallel parallel parallel parallel parallel
RCA	CTC22 CTC36 CTC38 CTC40 CTC42 CTC47	14 18 20, 23 23 16 23	tube tube xstr xstr	a.f.t. a.f.t. a.f.t., sound a.f.t., sound sect. a.f.t., several	yes yes	tube tube hybrid xstr xstr ²⁵	5-function 7-function 8-function 10-function	yes yes	auto auto auto auto auto	pulse pulse shunt pulse ¹⁶ none	2 2 3X 3X 3X 4X	X-Z lo X-Z lo X-Z D R-B-G-D R-Y, B-Y D n.a.	yes yes yes yes yes yes n.a.	series series parallel series series
SETCHELL-CARLSON	no longer in consumer television													
SHARP	CU-50P CY-61P CN-62T	12 15 18	tube tube tube	a.f.t. a.f.t.	yes	tube tube tube	5-function 7-function	yes	auto n.a. n.a.	n.a. n.a. n.a.	3	X-Z D X-Z D X-Z D	yes yes yes	n.a. n.a. n.a.
SONY	Plans to introduce 12-inch Trinitron, but no information was supplied.													
SYLVANIA	D05 D06 D11 D121 ⁶	18 20 14 23	tube tube tube 9/282	a.f.t. a.f.t. a.f.t. a.f.t.	Instant-Color	tube tube tube xstr	10-function	yes	auto auto auto auto	pulse shunt pulse shunt	3 3 3 3X	X-Z lo X-Z lo X-Z lo X-Z D	yes yes yes yes	series parallel parallel
TOSHIBA	C6A, 7A, 8A C41A, 51A	15, 18 15	13/182 13/182	a.f.t.	yes yes	xstr xstr	Instant-Color	yes yes	auto auto ¹³	pulse ¹⁸ pulse ¹⁸	3X 3X	R-G-B D R-G-B D	yes yes	series series
WEBCOR	CTV-15 CTV-18	15 18	tube	a.f.t.	Instant-On	tube	Instant-On	yes	auto	shunt	3	X-Z lo	yes	n.a.
WESTINGHOUSE	V-2655 V-2656 V-5001	18, 23 23 14	tube 24/112 tube	on-screen bars	Instant-On	tube tube tube	Instant-On	yes	auto auto auto	pulse pulse pulse	3 3 3	X-Z lo X-Z lo R-Y, B-Y	yes yes yes	series series series
ZENITH	12A10C15 12A12C52 14A9-A10- 14A9C50, 51 16Z8C19	14, 16 23 18 20, 23 18	14/102 14/122 16/92 16/92 16Z8C19	demod demod demod demod	a.f.t. a.f.t. a.f.t. a.f.t.	tube tube tube tube	6-function 4-, 6-function 6-function 4-, 6-function	yes	auto auto auto auto	pulse ¹⁶ pulse ¹⁶ pulse ¹⁶ pulse ¹⁶	3X 3X 3X 3X	IC IC IC R-Y, B-Y	yes yes X yes yes yes	parallel parallel parallel parallel parallel

Information was not received from the following companies: Airline (Montgomery Ward), Channel Master, Curtis Mathes, DuMont-Emerson, Hayakawa, Penncrest (J. C. Penney), and Sears/Silvertone.

NOTES: n, a, = information not available; 1, viewable diagonal inches; 2, some hybrids show how many tubes/transistors, includes tuners; 3, all u. h. f. tuners are transistor; 4, auto = automatic; 5, lo = low level, hi = high level, D = diodes, X = transistors; 6, motor-driven, but push-button operated; 7, called "Electrolok"; 8, all varactor-tuned tuners are solid-state; 9, designation for 70-degree, 21-inch round CRT; 10, has a. t. c. (automatic tint control) which is Magnavox exclusive this year; 11, Fine Tuning Indicator and Fine Tuning Lock; 12, two stages for each color; 13, using thermal timer relay; 14, has X and Z amps, plus R, G, and B amps; 15, called Autolock Channel Tuning (a.c.t.); 16, has signal-seeker u. h. f. tuning; 17, some use thermal timer, 4K10 uses special circuit; 18, pulse-load type; 19, mainly series, but some fed in parallel by transformer; 20, modular construction on plug-in circuit boards; 21, only limited information available; 22, special parallel-resonance regulating circuit; 23, changes from last year's TS-915/919 are slight—most notable is "Fast Back" chassis layout (see text); 24, X = transistors instead of tubes; 25, uses unique diode switching for channel changing.

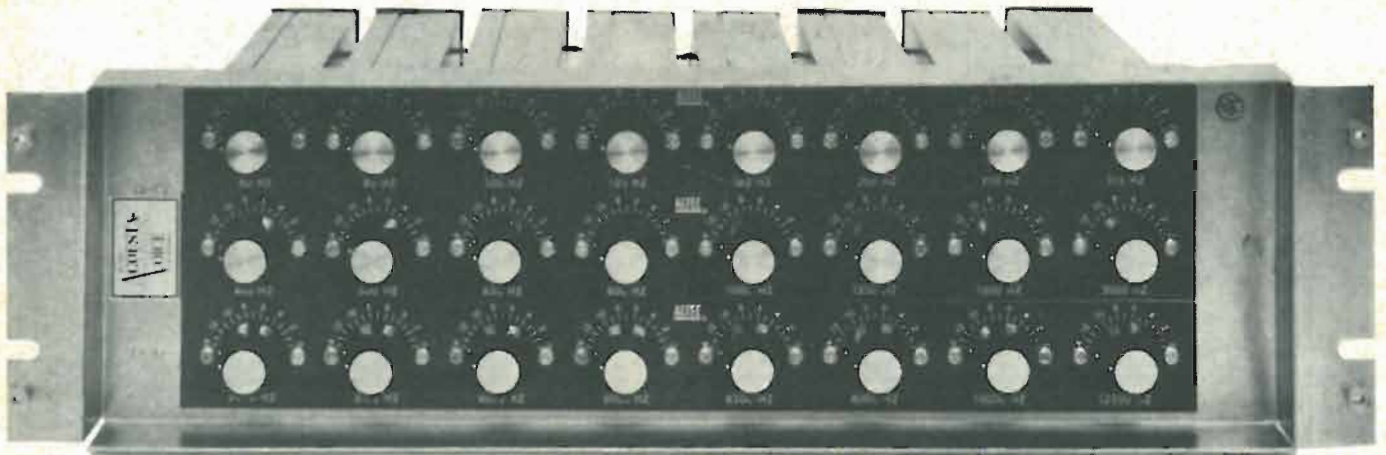

The Altec Lansing 24-filter Acousa-Voice equalizer. Each of the filters can be adjusted in 1-dB steps.

EQUALIZING the Sound System TO MATCH THE ROOM

Here's an equalizer system with 24 band-rejection filters that permits the hi-fi system to be matched to any room—whether an auditorium, concert hall, or at home.

By DON DAVIS and DON PALMQUIST/Altec Lansing (Div. of LTV Ling Altec)

HIGH-FIDELITY amplifiers can be purchased that are capable of maintaining a desired frequency response within ± 0.5 dB over the audible range. Recording microphones are available that have a frequency-response accuracy within ± 1.0 dB. Phonograph cartridges are available to the home music listener with ± 1.0 -dB variation in response. In fact, everything proceeds with commendable accuracy and inexorable control until the loudspeaker interfaces the sound system to the room, and the acous-

tics of the room interfaces the sound to the listener's ears.

Taking the worst-case variations from recording microphone through the various manufacturing processes and the entire playback chain, the loudspeaker may be fed a signal in the typical high-quality home-music system that is *electrically* accurate within ± 2 dB.

In spite of this most impressive technological achievement, the listener actually receives an acoustic signal at his ears that is typically ± 10 dB over the range of interest; and in the very best case, ± 4 dB. In several cases observed, the signal exceeded ± 15 dB in actual rooms with highly regarded high-fidelity equipment.

(Considered subjectively, a change of 3 dB is judged a "just noticeable difference." An increase in level of 10 dB is judged to be about twice as loud. Normal speech levels at a distance of about four feet from the talker measure between 70 and 76 dB.)

The blame for this condition can be almost equally divided between the loudspeaker and the room. This is true mainly because there are no real standards for the performance expected of either. Imagine how much easier the loudspeaker manufacturers' task would be if every listening room had the same shape, size, and absorption, with its loudspeaker placed in a standard location. This would mean that the manufacturer would build such a room at his factory and by placing measuring microphones at the "standard" listening position and the loudspeaker at its "standard" location, he could proceed with the optimum design to provide ± 1 -dB acoustic amplitude response at the listener's ears.

Until the housing industry decides that the audiophile market is of sufficient size to warrant such special measures and the required time cycle has elapsed to place everyone

Fig. 1. Acoustic response of the same speaker system in various rooms, different locations in the same room (both positions along the same wall but about 12 feet apart), and in an anechoic chamber.

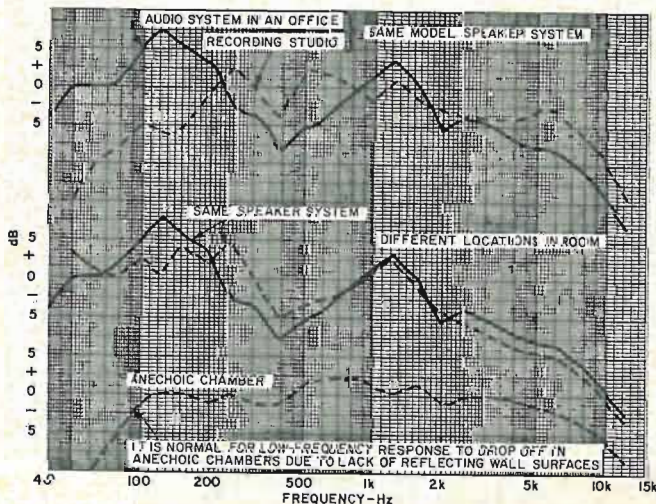

in his new environment, the problem remains with us.

Traditional Approaches to the Problem

Superficial thinking and knowledge about the acoustical properties of rooms have led some to assert that loudspeakers that exhibit uniform response in an anechoic chamber will continue to do so in a well-behaved acoustic environment outside the anechoic chamber. Such illusions are quickly dashed by a single session with a real-time audio-frequency spectrum analyzer and any high-quality loudspeaker in a typical recording-studio control, cutting, editing or re-mix room. Home living rooms are an even more rewarding environment for such study purposes.

An experimenter will quickly rediscover the over fifty years of observed "room effects" on the performance of a loudspeaker. Bass response will have "holes" in it, thanks to diaphragmatic absorption. This means that some large wall surface in an enclosed space acts as a giant diaphragm and passes the sound at that frequency out of the room by vibrating in resonance with the sound. "Peaks and valleys" attributable to standing waves resulting from the room's dimensions allow a build-up on wavelengths well within the audible range that first peaks the response and then cancels out, depending upon the listener's position in the room. Where the loudspeaker is placed in the room can have a profound influence on the response. For example, in the bass region, response can vary as much as 12 dB from a midroom location to a corner location.

Finally, the room shape and absorption characteristics will have their inexorable effects on establishing the ratio of direct-to-reflected sound at the listener's ears. Fig. 1 illustrates the response of the same loudspeaker system in an anechoic chamber, in different rooms, and at different locations within the same room.

Direct and Reflected Sound

In an anechoic chamber or out-of-doors, as we listen to a loudspeaker at some comfortable normal distance, say 10 or 20 feet, we hear predominantly direct sound. Most of the sound comes to us directly from the loudspeaker. When we go into an enclosed space, such as a living room, we encounter a situation where 10 or 20 feet from a loudspeaker we hear predominantly reflected sound. This means that most of the sound comes to us after first striking a wall or ceiling.

The "deader" a room of a given size, the larger the listening area where direct sound predominates. The "liver" the room is, the smaller is the area where direct sound predominates. Most listeners, whether at home with their hi-fi systems or at the concert hall listening to a live orchestra, sit in what is called the reverberant field where the reflected sound predominates.

Some experimenters have seized upon this aspect of the listening environment and attempted to control the ratio of direct-to-reflected sound in the room. Actually, what is desired is to reproduce in the home environment the same tonal balance the recording hall has in its reverberant field. To do this requires some method of adjusting, in each and every case, the frequency response of the reverberant field at the listener's position in the home to a uniform response, thereby allowing whatever balance the recording has to assert itself.

While different sounds can be produced by reflecting loudspeaker outputs off wall surfaces, accurate reproduction of a concert hall's acoustic environment comes from equalizing the loudspeakers used to produce essentially neutral interaction with the listening room. Then what is heard is a reproduction of the original environment.

Others have attacked the problem from another direction. They take into account the theoretical desirability of an imaginary, omnidirectional, pulsating sphere. However, all frequencies must radiate omnidirectionally, and this cannot be accomplished. To further compound the problem, a musical instrument does not radiate omnidirectionally (most have

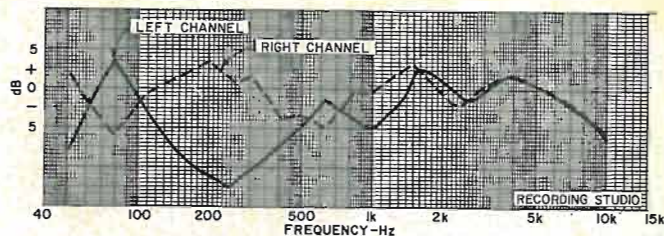

Fig. 2. Response of two identical loudspeakers in a recording-studio editing room prior to equalization. Measurements were taken at the control console operator's position. Differences in response in the 100- to 500-Hz region were dramatic on voices. Voices would appear to move rapidly from one channel to the other.

pronounced polar patterns) and, once in the reverberant field, one has difficulty telling direction in any case.

There Must be an Easier Way

During the past five years an idea was put forth that was first used to correct sound systems that had to operate in difficult acoustic spaces, such as cow-barn arenas, low-cost gymnasiums, or churches with poor acoustics. Both noise control and proper absorption materials had been neglected in many of these places. This idea was to use a highly refined, accurate, and rapid method of equalizing or adjusting the sound system to match the room rather than trying to adjust the room to match the sound system.

The history of sound-system equalization had its early beginnings in the work of Harry Kimball of MGM, Ercel Harrison of *Peerless Electrical Products* (a division of *Altec Lansing*), Wayne Rudmose of *Tracor*, and C. P. and C. R. Boner. In 1967 *Altec Lansing* produced the first fully adjustable, fully calibrated, critical-bandwidth, band-rejection equalizer design to permit matching the sound system to the room (see photo). The equalization process developed out of the use of critical-bandwidth filters is called "Acousta-Voicing®."

The equalizer (patent pending) consists of 24 constant-*k*, bridged-*T* band-rejection filters spaced at the standard $\frac{1}{3}$ octave center frequencies from 63 Hz to 12,500 Hz. These cross over at their respective "half-pad-loss" points, thereby allowing continuous shaping of a complete spectrum.

The term "Acousta-Voicing" is derived from the practice of voicing and regulating each pipe of an organ after it is installed in the room where it is to be used. The equalizer "tunes" the loudspeakers in the room where they are installed.

The system removes none of the usable program material, but rather brings into equality with the majority of frequencies those special frequencies that the room and sound system together actually tend to over-emphasize. As each over-emphasized tone is brought into equality with all the normal responding tones in the room, the sound quality is vastly improved. Highs and lows are in perfect balance, and the spatial effect in a multi-channel system is startling. (See Fig. 2.) Not only is the sound quality enhanced by being smoothed but now the original spatial relationships that prevailed at the original recording site are reproduced in sharp detail, scaled only by the relationship of the spacing of the recording microphones compared to the spacing of the monitoring loudspeakers.

The long-term effect on recording techniques remains to be seen, but it is possible to conjecture that when home systems are properly equalized, the recording engineer, knowing for the first time what the listener's environment actually is, can safely plan the final recording to sound its best under a "standard" listening situation.

Cost of Voicing

Voicing of a playback or reinforcement sound system to ± 1 dB final acoustic response at the listener's ears can be accomplished in 1½ hours per channel by a factory-trained engineer. This time is reduced to 10 to 15 minutes per chan-

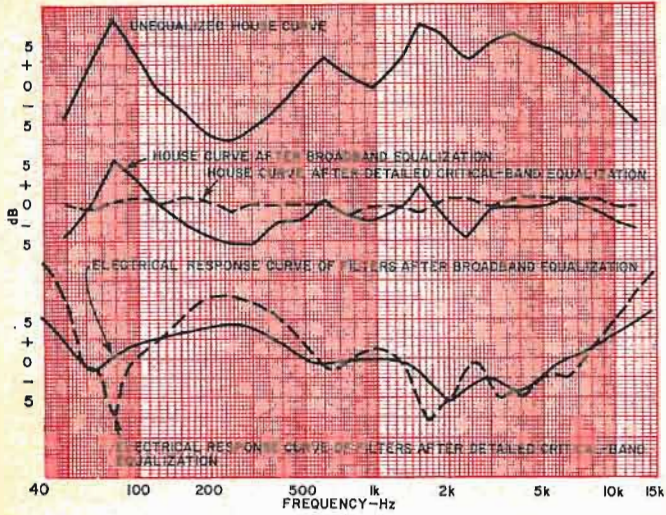

Fig. 3. Attempts to equalize a playback channel with broadband ($\frac{2}{3}$ -octave) filters compared to critical-band ($\frac{1}{3}$ -octave) filters.

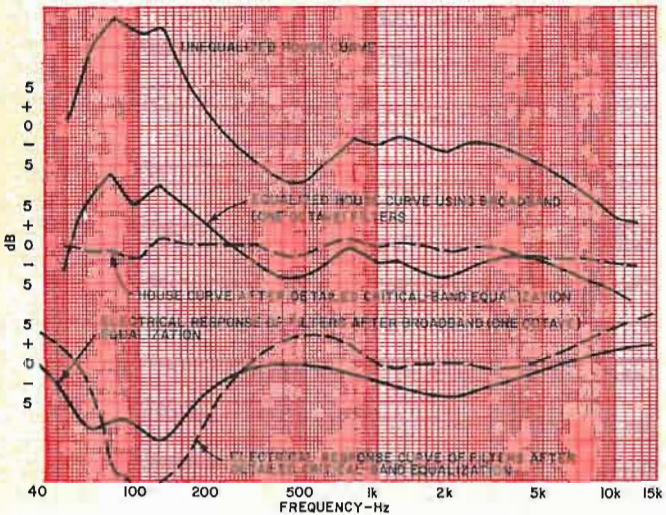

Fig. 4. The inadequacies of broadband equalization are again shown. This is what happened with a corner-mounted loudspeaker facing a wall of undraped floor-to-ceiling windows. The room "seized" the slight bass emphasis and exaggerated it considerably.

nel, after system set-up, with the use of a real-time audio frequency spectrum analyzer. The investment in test equipment is around \$10,000 and the cost to the customer is approximately \$1,500 per channel and up, depending on the complexity of the system. This is not restrictive for a large commercial installation, but it definitely is for all but the most elaborate home-music systems.

Considerable research has been undertaken to simplify the voicing process in order to reduce the cost for home music systems. Early work attempted to use first five controls with $1\frac{1}{2}$ -octave filters, followed by later tests using eight controls with $\frac{2}{3}$ -octave filters. While these allowed *different* sounds to be produced, they were not sufficiently detailed to actually improve the measured response. Unfortunately, they simply amounted to a more complicated set of tone controls.

It was determined that 24 critical-bandwidth filters spaced at the standard $\frac{1}{3}$ -octave center frequencies yielded optimum results. Any simpler equalizer could not provide equalization that corrected the problems measured without affecting adjoining frequency regions not requiring correction. See Figs. 3 through 5.

Equalizing in the Home

An intensive effort is being made to reduce the cost of the necessary 24-filter equalizer and to find a very simple but highly accurate and reasonably easy-to-learn tuning method.

it is expected that these particular goals will be met shortly.

The high-fidelity dealer will be instrumented for less than \$500 to "see" the interaction of the total system—the cartridge, loudspeaker, room—and the change in the house curve with each adjustment of the critical-bandwidth, band-rejection filters. He will be able to guarantee the music system to the customer with ± 1 dB acoustic response at the listener's ears. The voicing will be done at the customer's listening room in an hour per channel, and the total cost of the filters will be less than \$1,000 for a stereo system.

Fig. 6 is a diagram of where the equalizer is installed in the high-fidelity sound system. In altering a receiver, the technician should be aware that the output from the receiver's preamplifier will see a 600-ohm load and will often be capable of generating only 1 or 2 volts across it with low distortion. Most high-fidelity power amplifiers have input impedances in the region of 100,000 ohms and will require a termination resistor for the equalizer.

There is no need to "build out" the output of the preamp to 600 ohms but care should be taken to be sure to use a low-impedance output. The amplifier should be capable of reaching full output from .1 volt or less in order to meet the required gain overlap of 20 dB (if the preamp only put out 1 volt into 600 ohms).

It is obvious that only first-class equipment will easily adapt to voicing of this type. We suggest 50 watts as the minimum continuous power output to have available. This is because the equalizer is going to allow the system to use enormous power on a frequency-selective basis. This means that a signal can be sending the woofer 30 watts while the mid-range speaker may be receiving power on the order of .3 watt, even though equal sound pressure levels are being generated at both low and middle frequencies at the listener's ears. The 20 dB of equalization makes the difference. ▲

EDITOR'S NOTE: The lower-priced equalizer referred to above was demonstrated for the first time several months ago at the Los Angeles Hi-Fi Music Show. The equipment will be delivered shortly to selected hi-fi component dealers whose staffs will be trained to do the tuning.

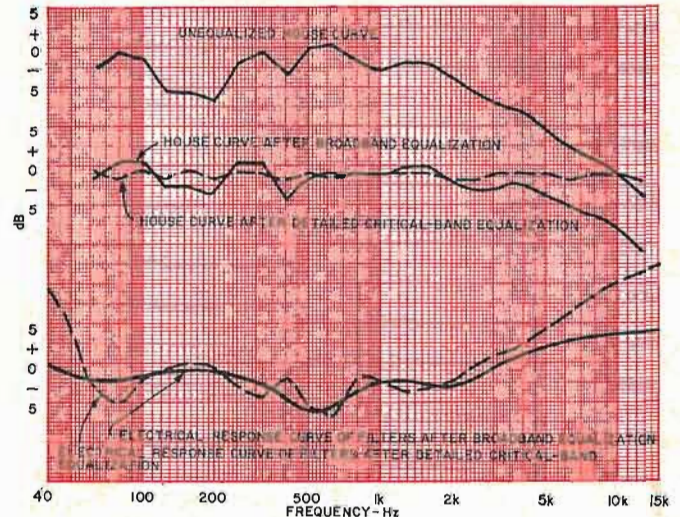
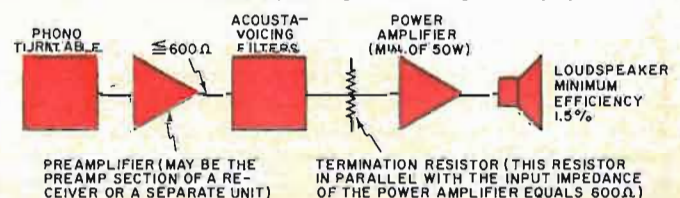

Fig. 5. The response curves of a relatively smooth system in which conventional tone controls can do much to restore overall balance. This type of system is difficult to equalize completely due to close spacing and steep slopes of irregularities.

Fig. 6. Installation of equalizing filters in high-fidelity system.



Scintillation Radiological Survey Meters

By J. G. ELLO

Radiation Measurements
and Instrumentation
Industrial Hygiene and Safety Division
Argonne National Laboratory

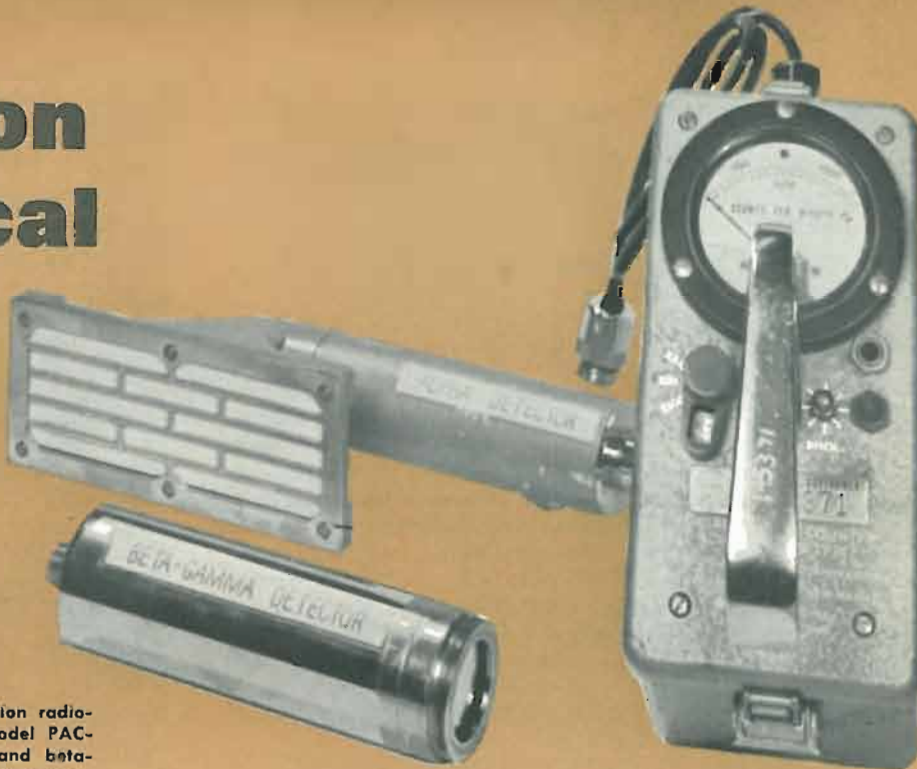

Fig. 1. Eberline scintillation radiological survey meter, Model PAC-15 shown with alpha and beta-gamma scintillation detectors.

The operation of radiological survey meters, specifically the scintillation type, is thoroughly discussed by the author. A complete description and maintenance techniques for a typical survey meter, the PAC-15, are also included in the article.

FOR a number of years, the nuclear instrumentation field has progressed at a steady pace, with many innovations in radiological detectors and their associated counting systems. Although many of the earlier types of survey meters, such as Geiger-Muller, ionization, and proportional counters (see *ELECTRONICS WORLD*, January, 1966) are still in wide use, they do not meet all present-day requirements. Along with the demand for sophisticated instruments is an ever-increasing demand for the nuclear instrument specialist. The author hopes that through this article he will help electronics technicians in the profession by increasing their knowledge of basic nuclear instrumentation.

Radiological instrumentation is now found in military, medical, and industrial fields as well as in research. This wide application of radiation has resulted in the development of new instrumentation and new types of detectors, such as thermoluminescent dosimeters, semiconductor detectors, and improved scintillation detectors.

Of the three types of detectors mentioned, the scintillation type is well established and in wide use in research and commercial work. The detector, with its photomultiplier tube (photo-tube), has a wide range of applications as compared to the Geiger-Muller or ionization types. It is particularly useful in accelerator studies where short resolving time and coincidence counting is required. In addition, the scintillator can measure the radiation energy and distinguish between types of radiation.

There are a number of scintillation-type counters used in the nuclear field which have the same principle of operation. In this article, the author discusses the *Eberline* survey meter, Model PAC-15, shown in Fig. 1 with its detectors. Among other manufacturers that produce scintillation survey meters are: *Nuclear Chicago*, *Ludlum Measurements*, and *Victoreen Instrument Corporation*. Selection of the *Eberline* instrument for discussion should not be construed as an endorsement of the meter, nor as an adverse criticism

of any of the meters used in the nuclear field today.

Scintillators

Scintillation counting is not new to the nuclear instrument field. With innovations in nuclear instrumentation, the scintillator has become a primary tool for the detection and measurement of *alpha*, *beta*, and *gamma* radiation.

Scintillation, by definition, is a spark, flash of light, or a twinkle of a star. The phrase "scintillation counting" goes back many years. Originally studied by Becquerl and Crookes, they found that some materials would emit flashes of light when exposed to nuclear radiation (similar to a radium watch dial). These flashes of light are referred to as "scintillations."

To make a scintillation detector, we must first have a phosphor material which scintillates when exposed to nuclear radiation. The phosphor should be able to absorb *alpha*, *beta*, or *gamma* radiation and thereby produce ionization and excitation within itself. For practical purposes, we could say that nuclear energy is converted to light energy. This fluorescent radiation or scintillation, as we shall see later, is what the photocathode of the photomultiplier sees and amplifies.

An ideal phosphor material is one which readily absorbs nuclear radiation, is highly efficient in converting nuclear energy to light energy (photons), has a fast scintillation decay, is transparent to its own scintillations, and has an emission wavelength matching the photocathode sensitivity of the photo-tube used.

At present there are five classes of phosphors (scintillation material). These are organic liquid and solid solutions, organic crystals, inorganic crystals, and noble gases. The type to be used depends on the type of radiation to be detected. For example, if *gamma* radiation is of interest, we may use an inorganic sodium-iodide crystal activated with a small quantity of thallium to create luminescent centers.



Fig. 2. Cross-sectional views of (A) gamma and (B) alpha scintillator packages showing physical and chemical makeup.

For *beta* radiation, an organic anthracene crystal may be used, and for *alpha* radiation, a very thin layer (powdered screen) of organic zinc-sulfide activated with silver is used.

For practical purposes, we can say there are three types of scintillation forms in use, that is, the phosphor material may be in a liquid, crystal, or powder form. Since we are discussing battery-operated survey meters, our interest lies in the latter two: the crystal state and powder scintillators.

An important property of a scintillator is the efficiency with which it converts nuclear energy to light energy, that is, the number of photons produced per nuclear event. The photons produced must pass through the scintillator to the photocathode to be counted. For this reason, the packaging of the scintillator is also of great importance.

Since the type of radiation to be detected determines the packaging technique to be used, we should review some of the basic properties of nuclear radiation.

Nuclear Radiation

Back in 1898, when Pierre and Marie Curie concluded that uranium gave off rays which were characteristic of that element and not related to its chemical state, they referred to this phenomenon as "radioactivity." As research work continued in the early part of this century, other elements were found to be radioactive which were also characterized by the emission of one or more of three types of radiation. The three types were named after the first three letters of the Greek alphabet.

The first, called *alpha* (α) rays or *alpha* particles, are helium nuclei each consisting of two protons and two neutrons with a positive charge. When ejected from a radioactive atom, the particle moves with considerable speed, approaching 20,000 mi/sec. It can only travel through 1 to 2 inches of air and is unable to penetrate a few sheets of newspaper.

The second type of radiation is called *beta* (β) rays or *beta* particles. The *beta* particle is emitted from the nucleus of a radioactive atom and has a mass and charge equal in magnitude to that of an electron. *Beta's* can travel several hundred times farther than the *alpha* particle and at speeds approaching the speed of light. A *beta* particle, with the same energy as an *alpha*, will move much faster and go farther before its velocity is brought to zero by collision with the atoms which it ionizes. In other words, a *beta* particle, which can pass through a number of sheets of newspaper, is easily absorbed (stopped) by a 1/4-inch sheet of Lucite even though its energy is the same as the *alpha* particle. This is logical since the mass of the *alpha* particle is approximately 7500 times greater than that of a *beta* particle.

The third type of radiation is referred to as *gamma* (γ) rays. Unlike *alpha* and *beta* radiation, *gamma* radiation does not consist of particles. It is a short-wavelength electromagnetic radiation of nuclear origin. It is emitted from a disintegrating atom when an excess of energy remains after the ejection of an *alpha* or *beta* particle. *Gamma* rays move at the speed of light and are similar to x-rays, therefore, they have a greater penetrating ability.

Protection against α and β particles can be obtained by a shield made of glass or a 1/4-inch thick plastic such as Lucite. However, with γ rays, a lead, steel, or concrete shield is necessary. The best protection against nuclear radiation is

to keep as far as possible from the source and limit exposure time.

Scintillator Detectors

As mentioned earlier, the packaging of a scintillation detector depends on the penetrating ability of the radiation to be detected. It can be packaged in many shapes and sizes with the primary consideration being given to the prevention of any light transmission from the outside. The diagram of Fig. 2A is a cross-section view of a packaged *gamma* scintillator. It incorporates sodium-iodide activated with thallium to form an *NaI(Tl)* crystal which is enclosed in a 0.0312-inch thick aluminum can. The inside of the can is coated with a very thin layer of aluminum oxide for the purpose of light reflection. The photo-tube end of the can is sealed with a 0.01560-inch thick glass, quartz, or Lucite window, referred to as a light pipe, and in this case, equal in area to that of the photocathode of the photo-tube. The scintillator package is then placed in a light-tight container housing the photomultiplier and its associated circuit, as seen in Fig. 1. When installing the scintillator package to the face of the photo-tube, it is necessary to have good optical contact between the two surfaces to minimize any reflection at the interfaces. The optical connection may be accomplished by sandwiching some transparent material, such as silicone grease, between the photo-tube and the light pipe.

A scintillator for detecting *beta* particles is packaged in a similar manner, except that a 0.1875-inch thick anthracene crystal is used in place of the *NaI(Tl)* crystal. Also, the aluminum can must have the end opposite the photo-tube removed and replaced by a 1-mil (one thousandth of an inch) thick aluminum foil, which acts as the *beta* window. The window permits the *beta* particle to come in contact with the crystal and is similar in design to the *alpha* scintillator window shown in Fig. 2B.

An *alpha* scintillator may be housed like the *beta* type, that is, like the *beta* scintillator, it needs a very thin light-tight window to allow passage of low energy particles. The aluminum can must have both ends open. The photo-tube end of the can has a light pipe attached for light transmission and is equal in area to that of the photocathode. The opposite end of the can, which is the *alpha* window, is constructed from a 0.25-mil thick opaque layer of aluminized Mylar. Directly under this Mylar window is the *alpha* scintillation material, consisting of a silver-activated zinc-sulfide powder *ZnS(Ag)*. A very thin layer of this powder has been specially fabricated as a decalomania scintillation screen. This screen is highly sensitive to *alpha* particles, that is, they are readily absorbed, whereas the *beta-gamma's* are not and go on through the screen undetected. The zinc-sulfide screen, as seen in Fig. 2B, adheres to the transparent Lucite light pipe. In some instances, the screen can be applied directly to the face of the photo-tube, thus obviating the need for a light pipe.

When an *alpha* particle penetrates the Mylar window, it strikes the *ZnS(Ag)* screen, which undergoes a change and emits a minute flash of light which is seen by the photo-tube and is amplified accordingly. This same phenomenon occurs in the radium dials of clocks and watches. Here a small amount of radioactive material, such as radium, is mixed with some zinc-sulfide so that the *alpha* particles are always colliding with it, thereby emitting light. This light can then be seen on the dials in the dark. By using a sensitive photoelectric cell, such as the photomultiplier tube, these scintillations can be converted into electrical energy as is done in the *alpha* scintillator.

Photomultiplier Tube

In the early stages of scintillation counting, an attempt was made to use an ordinary photo-tube. This particular tube may work fine in chain stores to open and close doors,

but it is unsatisfactory for scintillation counting. The drawbacks with this tube are its poor response toward faint light flashes and the high level of noise generated by its associated circuit. In 1944, it was decided to construct a special photo-tube which would be self-contained, consisting of a photoelectric cell followed by a high-gain amplifier that depended on the phenomena of photoelectric and secondary emissions. To understand this phenomenon, we should understand that electrons are held captive in various materials by means of the potential barrier and that to release them sufficient energy must be applied to these electrons so that they are able to cross this barrier. For example, if incident (primary) electrons bombard a material and transfer all or part of their energy to the electrons the material contains, they in turn would release additional electrons which causes so-called secondary emission.

By examining the basic configuration of a photomultiplier tube, shown in Fig. 3, we find it consists of four major interior parts: (1) The *photocathode*, which is a semi-transparent photosensitive film deposited on the inside of the flat end of the tube's glass envelope. This photosensitive material should be dependent on the light wavelength of the emission spectra of the scintillation material used. A sensitive material consisting of an alloy of cesium-antimony is widely used because of its sensitivity to light wavelengths up to about 6500 Å, which is well within the emission spectra of most scintillators. The main function of the photocathode is to convert light energy to electric energy by means of photoelectric emission, that is, to absorb photons and in turn release electrons. (2) The *electron optical element* or funnel, as it is more commonly called, acts as a guide to insure that all the electrons released by the photocathode are directed to the first dynode. When a proper voltage is applied to the funnel, it acts as a focusing electrode which accelerates the freed electrons to beam onto the first dynode; that is, all the freed electrons, irrespective of the emanating point on the photocathode, reach the first dynode. (3) The *dynode assembly*, the key factor of the photomultiplier tube, comprises the first dynode and all succeeding dynodes. The assembly may consist of from 6 to 14 dynodes, arranged in a cascade (ladder-like) configuration. By means of the secondary-emission phenomenon, each dynode is in itself an electron multiplier (current amplifier), thus the name, photomultiplier. The dynodes are constructed so that each one acts as an electron optical element for drawing the secondary electrons from one dynode to the succeeding dynode. To enhance secondary emission, an alloy of cesium-antimony, silver-magnesium, or copper-beryllium is coated on the dynodes. (4) The *anode*, sometimes called the collector, which collects all the electrons from the last dynode. The output from the anode of the photomultiplier is then coupled directly to the output counting circuit.

Fig. 4 is a schematic of the scintillation detector assembly consisting of a scintillator, photo-tube, and preamplifier. With reference to Fig 4, the action within the detector is as follows. Nuclear radiation (a) is absorbed by the scintillator (b) causing ionization, which is the conversion of nuclear energy into light energy (c), referred to as scintillation. By means of the light pipe (d) and reflector material (e), a large portion of the scintillation reaches the photocathode (f). By means of photoelectric emission, the freed electrons from the photocathode are funneled by the electron optical element (g) to the first dynode (h). At the first dynode, as well as the other dynodes, the secondary-emission phenomenon occurs. The freed electrons released by the first dy-

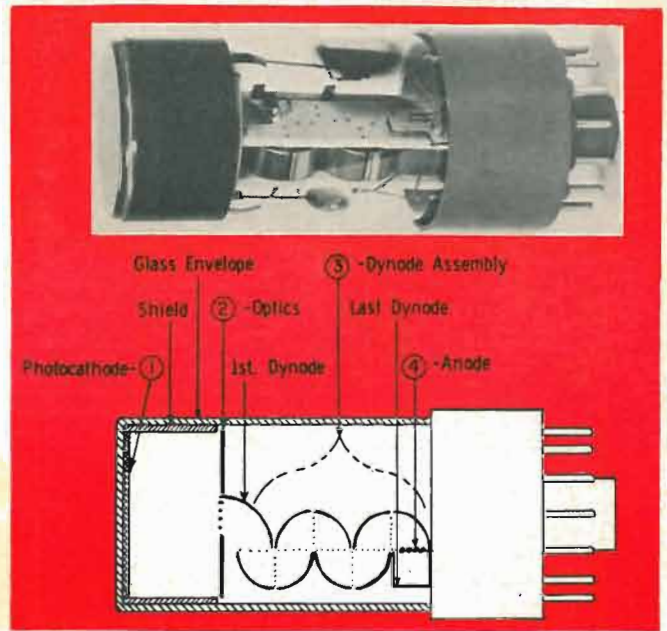

Fig. 3. Photograph and cross-sectional view showing the four major parts of a photomultiplier tube. The dynodes, by the secondary-emission phenomenon, act as electron multipliers.

node (i) are funneled to the second dynode. Upon impact, additional electrons are freed and, in turn, are attracted by the succeeding dynodes in sequential order. At each dynode, the number of freed electrons multiply by the electron-multiplication process. At the last dynode (j) all electrons are then funneled to the anode (k), producing an output pulse (l) which may then be coupled to its associated counting equipment via the preamplifier.

PAC-1S, Functional Operation

The PAC-1S (Fig. 1) is a commercially available scintillation counter built to meet governmental and commercial specifications and designed primarily for scintillation counting. The PAC is battery operated by five standard "D" cells or five RM-42 mercury cells and is referred to by such names as "Radiac," "Scint Pac," and the early models as "Poppy." Scintillation counters are widely used by governmental agencies, commercial and national laboratories, and many educational institutions. The PAC can be used with either an *alpha* or *beta-gamma* detector and is calibrated to present a meter reading from 0 to 2,000,000 counts-per-minute (CPM) of nuclear radiation in four range scales ($\times 1$, $\times 10$, $\times 100$, and $\times 1000$). Meter readings are indicated on a 0-20- μ A meter and an audio output phone jack is also included. Each meter count gives an audible click.

Fig. 4. Schematic representation of gamma scintillation detector showing functional relationship among scintillator, photomultiplier tube, and preamplifier.

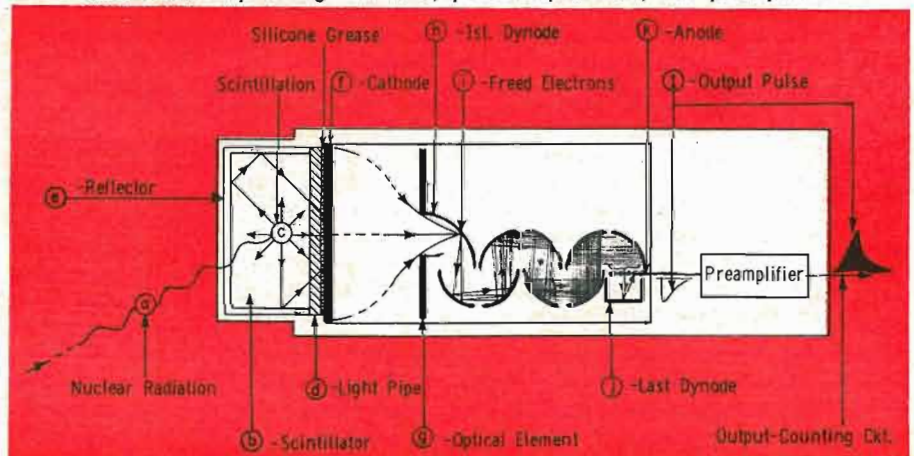

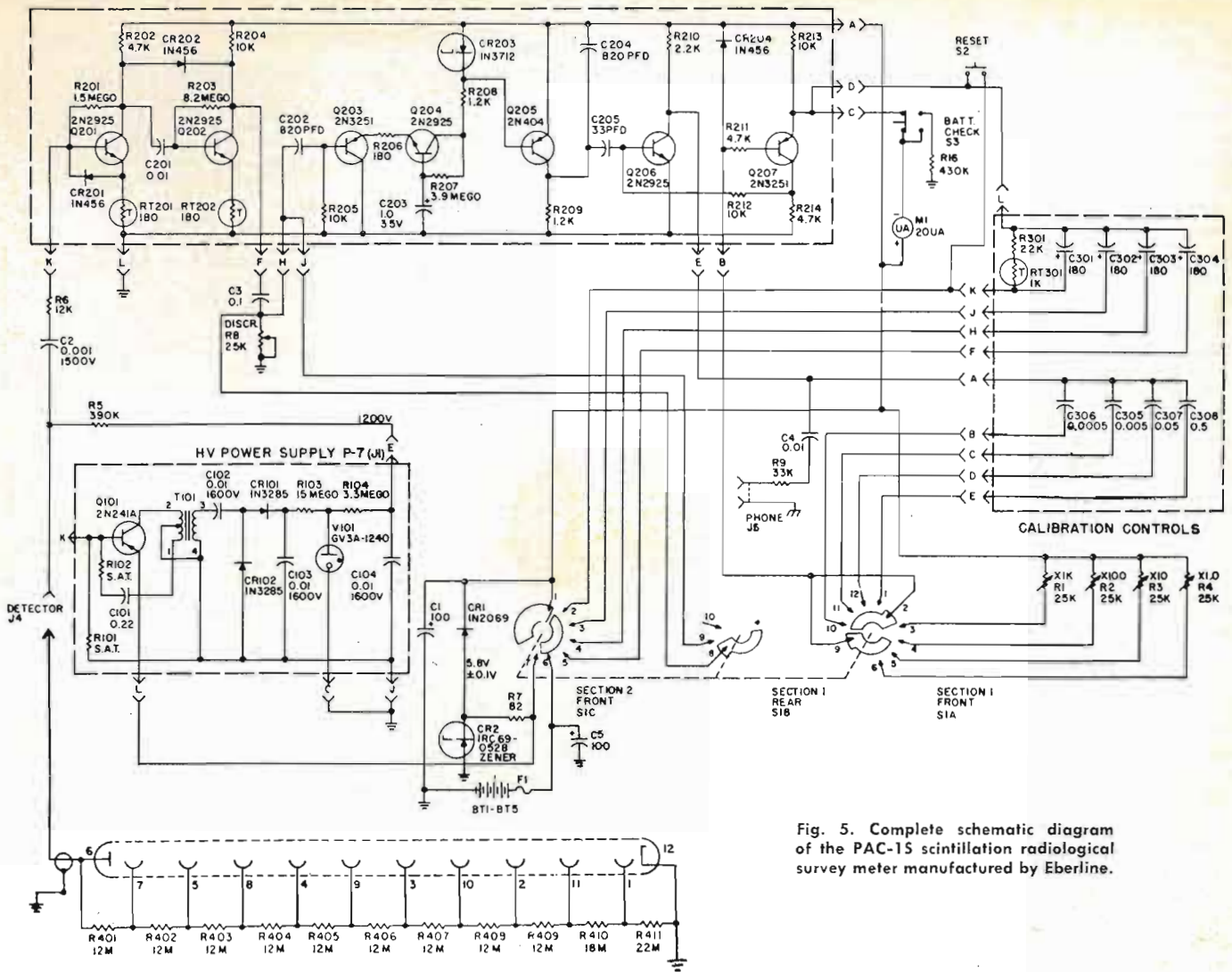

Fig. 5. Complete schematic diagram of the PAC-15 scintillation radiological survey meter manufactured by Eberline.

The electronic circuits are: a high-voltage supply for the detector, an amplifier, a pulse-height discriminator, and a trigger circuit. The panel-mounted controls (Fig. 1) consist of a range-selector combination "on-off" switch; a battery-check button that, when pressed, will indicate on the meter the battery supply condition; a "Reset" button which returns the meter pointer to zero; and a discriminator control, "Discr.," to determine the minimum size pulse to be accepted from the detector. In addition to the range-selector switch, each range has an internal calibration control as shown in Fig. 5.

Referring to the circuit diagram of Fig. 5 the basic operation of the PAC is as follows. Regulated high voltage is supplied by a blocking oscillator circuit made up of transistor Q101, transformer T101, and their associated components. The a.c. voltage produced by the oscillator induces a voltage in the secondary winding of T101. Capacitors C102 and C103 and diodes CR101 and CR102 make up the voltage doubler and filter network. The resultant detector high voltage is regulated at 1240 volts by corona regulator tube V101. Capacitor C104 further filters this voltage which is then applied to the detector voltage-divider network through resistor R5. The divider network consists of a series-resistor string (R401 through R411) which provides each photo-tube dynode with the proper voltage for electron multiplication.

When the detector is placed in a radioactive field and the proper regulated high voltage is applied to the detector, a negative-going output pulse will be coupled through capacitor C2 to the two-stage amplifier circuit, consisting of transistors Q201 and Q202 and their associated compo-

ponents. To compensate for temperature changes in the input components, the amplifier contains two temperature-sensitive resistors (RT201 and RT202) for stability. Diode CR201 is used to help prevent damage to the input transistor if the detector voltage should be shorted to ground. Diode CR202 is used to limit the amplitude of large input pulses. When panel-mounted discriminator control "Discr." (R8) is set at maximum, the over-all gain of the amplifier is approximately 250. The amplifier output is coupled to the pulse-height discriminator stage through discriminator control network C3, R8, and C202. Discriminator input transistor Q203 is a common-collector circuit and its output is directly coupled to transistor Q204. Resistor R205 provides the bias for Q203, and resistor R206 supplies a negative feedback between Q203 and Q204. Transistor Q204 is wired as a common-base circuit and drives tunnel diode CR203. The function of Q204 is to supply a current source to control the tunnel diode. When this current source reaches 1 mA, it drive the diode into a high-voltage state (negative resistance). This voltage is sufficient to saturate transistor Q205, which is normally cut off. Q205 will remain saturated as long as the diode is in the high-voltage state. When the diode current decreases sufficiently, the tunnel diode will revert to its normal state and Q205 will cut off.

If pulses are of minimum amplitude, the trigger circuit which is a monostable multivibrator composed of transistors Q206 and Q207 and their composite parts, will go into operation. In its quiescent state, both transistors are at cut-off (non-conducting). When a proper size positive-going pulse appears at the base of transistor Q206, it turns Q206 on (conducting) and this, in turn, sets the trigger

circuit into operation. With this action, a negative-going signal is developed across resistor R210 which is coupled through preselected timing capacitor C308 and resistor R211 to the base of Q207, causing it to conduct. This, in turn, generates a pulse across collector resistor R214 of Q207. A portion of this pulse is fed back to Q206 through resistor R212, thereby maintaining Q206 in saturation. This additional voltage also holds timing capacitor C308 in a charged state which, in turn, maintains Q207 in saturation. During the charging time of C308, the base of Q207 approaches the battery voltage, driving it out of saturation. During this time its collector voltage will also start to decrease, thereby causing Q206 to start out of saturation. At this point, Q207 will cut off, causing its collector voltage to drop to near-ground potential. This drop in collector voltage is coupled to the base of Q206 causing it to cut off. The time that Q207 conducts depends on the preselected timing capacitor (C305, C306, C307, or C308) and their associated resistors (R1, R2, R3, or R4) which are also preselected by the panel-mounted range selector (S1A).

During the conduction period of Q207, a current will flow through the indicating meter (M1), developing a voltage drop across it. This voltage will charge up one of the preselected meter integrating capacitors (C301, C302, C303, or C304). When Q207 stops conducting, the preselected integrating capacitor will discharge through the meter, maintaining an average meter reading. The same pulses affecting the meter are also applied to the phone jack (J5) for aural monitoring.

Maintenance

Many scintillation survey meters, although ruggedly constructed, are delicate instruments. Severe shock to them might result in damage to the microammeter movement, the photomultiplier tube, or cause the scintillator to crack. A word of caution: *the indicating meter is very delicate*. If it is necessary to make continuity checks, the meter should be shorted out by placing a wire across its terminals. The electronic components used in most survey meters are standard parts and can be checked readily by conventional means. It is good practice to remove the instrument from its case periodically and inspect for moisture, dirt, and battery-voltage contact corrosion. In due time the contacts become corroded and also electrodeposition action sets in, causing the survey meter to be erratic or fail to operate. When battery-operated instruments are to be stored, they should be kept in a dry place with batteries removed.

The scintillation detector is the most expensive part of the survey meter, therefore it should be handled with care. A single photo-tube may cost from \$25.00 to hundreds of dollars, depending on size. It is strongly recommended that photomultiplier tubes be stored in complete darkness and, when used in a survey meter, never be exposed to light when connected to the power supply. This is one of the main causes of failure of the *alpha* and *beta* scintillation detectors. The light-tight Mylar windows are very easily damaged by careless use, resulting in scratches or ruptured windows, thereby allowing excessive light to reach the photosensitive cathode. Whenever the window is damaged, the meter will indicate an excessively high reading or may saturate and give no reading at all. The damaged area can be repaired temporarily by applying a small amount of black lacquer over the damaged area, sealing the light out. It should be kept in mind that the lacquered area will not pass low energy particles such as *alpha*'s.

The scintillator is also expensive and should be handled with care. A scintillator can be affected by various conditions. For example, a false reading will be indicated on the meter if the scintillator is exposed to ambient light, mechanical strains, heating, and to certain chemicals. Some crystals may rupture when exposed to excessive temperature changes. A sodium-iodide scintillator, which is hygro-

ABNORMAL INDICATION	PROBABLE FAULT
No indication on meter	(a) connections, battery contacts; (b) batteries; (c) controls; (d) meter movement
Indicates high reading on all ranges	(a) contamination; (b) detector; (c) noisy cable; (d) calibration; (e) see last abnormal indication
Indicates low reading on all ranges	(a) calibration; (b) batteries; (c) high voltage is low; (d) detector
Indicates erratically	(a) connectors, battery contacts; (b) detector; (c) dirty insulators
Meter saturates (reads up then drops to zero)	(a) detector; (b) high radiation field
Resists proper calibration	(a) detector; (b) controls; (c) batteries
Incorrect reading when checked with check source	(a) calibration; (b) batteries; (c) detector
Indicates up-scale with no radiation present	(a) calibration; (b) detector; (c) high voltage too high

Table 1. Fault-location chart for scintillation survey meter.

scopic, must be hermetically sealed so as not to come in contact with moisture.

Other components that can cause erroneous readings are the detector insulators, high-voltage insulators, and the feedthroughs. The slightest contamination of these parts by perspiration, dirt, or oil will create leakage paths. If surface leakage is suspected, cleaning with 170-proof methyl alcohol is recommended.

False readings can also result if the *alpha* detector is exposed to high concentrations of *alpha* or *beta-gamma* nuclear fields or nuclear contamination of the detector. For example, in some cases, should the *alpha* scintillation detector be exposed to high levels of *alpha*, the detector light level becomes so great that the counting circuit cannot resolve the pulses, resulting in a zero or near-zero reading. As for the high levels of *beta-gamma*, an erroneous reading will result if *alpha* radiation is to be measured in an area also contaminated with *beta-gamma* radiation. If this kind of situation exists, the surface area of the detector should be blocked out with paper, this would then block out all *alpha* radiation. If the survey meter still indicates and the detector is not contaminated, one of two procedures should be used. (1) Measure the *beta-gamma* reading and subtract this value from the total *alpha*, *beta-gamma* reading, or (2) adjust the discriminator or sensitivity control until there is no *beta-gamma* indication on the meter (this makes the meter less sensitive). After the initial adjustment is made, be sure to check for *alpha* sensitivity with an *alpha*-check source. If the reading is lower than the calibrated value, all further *alpha* readings must be corrected by this factor. Upon completion of the survey, the meter should be recalibrated for a proper *alpha* reading. *Warning: Calibration of all types of survey meters should be done only by qualified personnel trained in the use of nuclear radiation.*

In addition to the above limitations, a fault-locating chart (Table 1) is included. It indicates some of the typical malfunctions encountered and their probable causes.

In general, most battery-operated survey meters have an accuracy of ± 10 to 20 percent of full-scale reading. They are designed to be used as indicators of radiation and not for absolute measurements. When purchasing any instrument, it is a good practice to read the instrument's maintenance/operator's manual. A person can learn a lot about the instrument from its manual. For example, operational instructions, theory of operation, diagrams, preventive maintenance, calibration curves and procedures, pictorial illustrations, parts list, and above all, instrument limitations are usually included in the manual. Most reputable manufacturers supply this information on request. ▲

Taming Radar Weather Clutter

By HOWARD L. McFANN

Project Manager

National Aviation Facilities Experimental Center, FAA

By using magnetic tape recorders to "capture" radar storm signatures, the FAA hopes, through test and evaluation programs, to improve control personnel's ability to identify and track air traffic in less-than-ideal weather conditions.



Air traffic control specialist for the FAA evaluates weather contours generated from recorded radar data. This data, collected from storms and aircraft, is evaluated so that in the future it will be easier for control personnel to differentiate aircraft from the various types of weather environments.

Fig. 1. FAA project engineer adjusting two-channel Ampex F-950 rotary head instrumentation tape recorder used in development of a processing subsystem for radar data to help traffic control personnel better identify aircraft during storms.



INCREASING congestion in the skies above our nation's airports and along the airways constantly challenges the air traffic control specialists of the Federal Aviation Administration. Charged with the responsibility for the safe and orderly flow of air traffic, they fulfill their duty to thousands of air travelers each day despite forces that conspire to complicate their job.

One of these forces is the presence of weather clutter on their radar indicators. The weather returns appear as noise that interferes with the radar signals from aircraft. As a result, it is often difficult to identify and track the air traffic.

FAA's Answer

But while everyone talks about the weather and few do anything about it, the FAA is developing a realistic answer to the problem by an aggressive program that seeks to improve the display of aircraft in clutter. The payoff will be to increase the capability of control personnel to direct air traffic in bad weather.

At the National Aviation Facilities Experimental Center (NAFEC) of the FAA in Atlantic City, New Jersey, officials are perfecting a radar digital-processing subsystem for weather and aircraft data. The subsystem is part of the automated National Airspace System (NAS) that will provide automated or semi-automated tracking and display of aircraft and radar weather clutter. Within a few years, it will be used throughout the nation to help direct the ever-increasing volume of air traffic.

There are two complementary airspace systems being developed. One will be the *enroute* system with a 200-mile range; the other a *terminal* system with a 60-mile range

(Fig. 3). The enroute system is now undergoing test at NAFEC and the first stage has been implemented at the Jacksonville, Florida, Air Route Traffic Control Center. Future plans call for installation of the terminal system at high-density sites throughout the country.

Instrumentation

As part of the instrumentation used to develop the system, *Ampex* wide-band magnetic tape recorders are used to record radar data representing storm signatures and aircraft during different weather environments. These tapes are later played back for analysis and system optimization. The recorders are rotary-head instrumentation recorders similar in design and bandwidth to professional video tape recorders. The NAFEC recordings are replayed as often as necessary to set up standards of comparison while testing system components. Before utilizing magnetic tape recording, storm signatures were impossible to simulate or record. As a result, tests could only be conducted in "live" conditions, and no standard of comparison could be established.

Storm Signatures

Storm data is made up of radar returns from particulate matter such as ice and rain in the air. Each storm has a characteristic signature which shows direction and indicates approximate intensity in terms of the density of the hydrometeors. Previously, conventional radar-indicating devices such as plan position indicators (PPI) and "A" scopes were used to study these storm signatures and their effect on aircraft signals in real time (Fig. 2).

Now, using magnetic recording, it is possible to reproduce with all its original intensity the storm data that has previously been recorded in the field. The characteristic signature of rarer disturbances such as hurricanes and tornadoes can be repeated at any time without waiting for another to occur. The highly accurate time base of the recorders reduce jitter problems to a negligible level so that the reproduced storm data can be used in digital detectors.

Recorded Data

Several types of radar data commonly recorded, both at Atlantic City and various field sites, are linear receiver output, logarithmic receiver output, moving target indicator, and beacon (ATCRBS) aircraft identification signals. In situations where NAFEC wants to record more than one type of data simultaneously, a two-channel recorder is used (Fig. 1). Radar data is presented to the recorder in the form of detected video made up of low-frequency clutter blocks and narrow pulses representing aircraft. The pulses may have a rise time as fast as 100 nanoseconds and repetition rates up to 1500 pulses per second. The radar triggers are multiplexed as negative spikes while the radar video is positive-going pulses. Thus, full utilization of each wide-band recording channel is permitted. During recording, input radar signals are paralleled into a PPI scope for monitoring.

To show radar antenna position, output from the two-speed positional servo system and an azimuth pulse generator are multiplexed and recorded on the subsystem's two auxiliary channels. A time code and voice-cueing signal also are recorded on the auxiliary channels to aid in identifying specific activities on the tape.

Data Processing

The recorder output is treated as a live radar source in two distinct test and evaluation programs. In one case, the analog radar signals are used as inputs to existing data processing and display hardware. By repeated playback, the equipment operating parameters can be optimized. The other use for the reproduced radar is in the computerized signature analysis. The recorded storm signals are processed by a multi-level quantizer for recording by the *IBM 7090*

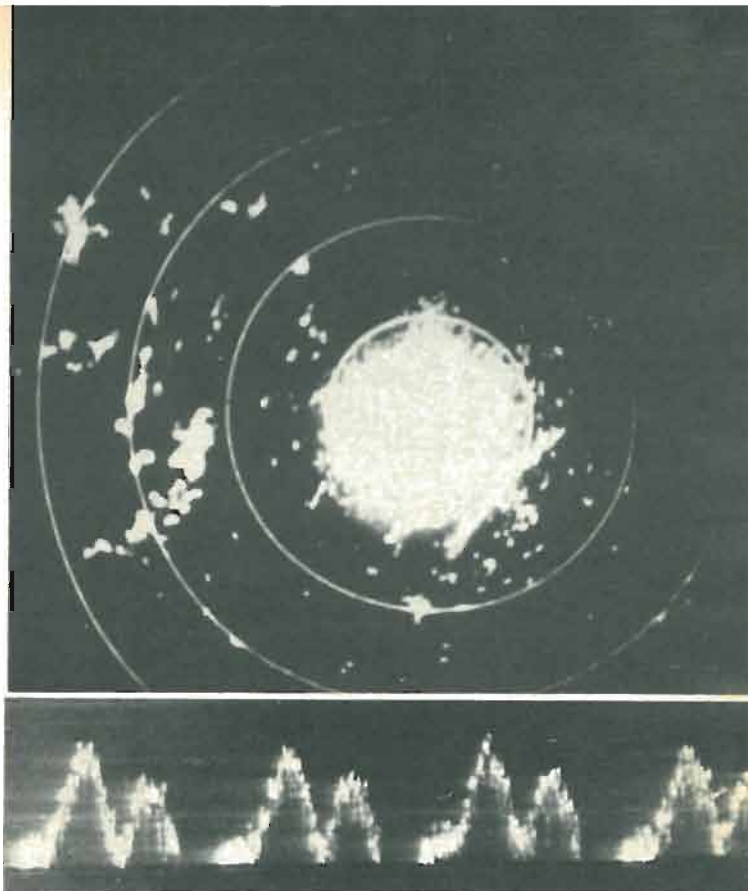

Fig. 2. (Top) A typical plan position indicator display of weather clutter. Magnetic tape recording now makes it possible to continuously repeat storm data to assist the FAA personnel in studying storm signatures' effect on aircraft. (Bottom) Single-sweep "A" scope display of weather formation.

computer. The resulting digital tape is then used in various analysis programs that determine essential characteristics such as range and azimuthal correlation coefficients, and power gradients.

Instant Weather

In effect, the illusive radar storm signatures have finally been captured. The NAFEC instrumentation, consisting of the *Ampex FR-950* tape recorder and the *IBM 7090* computer, provides instant weather for use in many of their test and evaluation programs. It is anticipated that this facility will be used with increasing frequency as more and more air traffic control engineers become aware of its capability. ▲

Fig. 3. FAA 60-mile range terminal radar system that will be used in conjunction with a 200-mile range enroute system to provide automated or semi-automated tracking and display of aircraft and radar weather clutter. The FAA has plans for automating such terminal radar systems at high density sites.



TV-FM LEAD-IN:

How to select the right kind of lead-in for your antenna. Complete rundown of all the various types now available, performance, cost.

IN some localities, an indoor TV or FM antenna works fine. But in most locations, you need an outside antenna to get a clean TV picture or good FM sound. To use an outdoor antenna, you need lead-in wire, to carry the r.f. signal from the antenna to the receiver. But you cannot simply connect any type of wire between the antenna and receiver. You have to use the right kind, and there are several types on the market. Here's how to select the right one for your installation.

Lead-in Requirements

To do the job properly, lead-in wire must meet certain requirements.

1. The lead-in must match the impedance of the antenna, and that of the receiver's antenna-input circuit. Most TV and FM receiving antennas are 300-ohm types, and most TV and FM receivers similarly have 300-ohm inputs. You can get either 300- or 75-ohm lead-in, and you can get transformers to match 300 ohms to 75, and *vice versa*.

2. The lead-in should attenuate the r.f. signal as little as possible (or cause as little signal loss as possible), because if the signal is too weak when it reaches the receiver, you'll get a snowy picture or a noisy FM signal. If you live in a high-signal area near the broadcast stations, this may be no problem. But if you live in a near-fringe or fringe area, you may need lead-in with the lowest possible loss. And color-TV and stereo-FM are even more sensitive to signal attenuation.

3. The lead-in should not add anything to the signal it gets from the antenna, that is, the lead-in itself should not pick up any direct r.f. signal, whether from TV or FM stations, or other radio signals, or noise (ignition or otherwise). If the lead-in does pick up other signals, such signals cause interference in the TV picture or FM sound. Of course, no lead-in is perfect, and all pick up *some* spurious signals. But some pick up less than others. If you live in a sparsely settled area, you won't have to worry much about unwanted lead-in pick-up, for there won't be much r.f. around. But if you live in an urban area, spurious r.f. and noise may be heavy in your neighborhood. Even if spurious r.f. and noise are no problem,

direct pick up of the TV signal by the lead-in causes ghosting to the picture or multipath distortion with FM.

4. The lead-in should be durable, since it's outside the house and exposed to wind, snow, ice, sun, rain, soot, and salt. All of these elements deteriorate the plastic insulation or jacket of the lead-in eventually; some go bad sooner than others. Also, with some lead-in types, rain, snow, and ice make the TV picture or FM sound worse. Obviously, long life is a desirable lead-in characteristic, as you have to replace the lead-in less often, and it costs you less in the long run.

5. The lead-in should be easy to install. A lead-in which is sensitive to nearby metal objects (6" or closer) is more difficult to install than one which is not, because most houses have such metal objects as rain gutters and downspouts on the eaves and corners, and you have to avoid them when running the lead-in. The same consideration applies to lead-in types which are sensitive to nearby a.c. lines. With some lead-in types, also, the use of metal-ring stand-off insulators can be detrimental to signals; you have to use nonmetallic stand-offs.

6. The lead-in should be reasonably priced. You can buy very good lead-in which will do quite well in meeting all the preceding requirements. But it may cost several times what more common types do.

Stereo-FM, Color-TV, and U.h.f.

All lead-in types attenuate the signal somewhat. This attenuation increases as the length of the lead-in does, and it also increases with the signal frequency.

Since the noise level is generally constant at the receiver r.f. input, the greater the signal losses in the lead-in, the noisier the signal, or the snowier the picture.

For good stereo-FM, you need a fairly clean r.f. signal, for noise degrades stereo separation by interfering with the relatively weak 19-kHz pilot and the stereo-AM sidebands around 38 kHz. Similarly, for good color-TV you also need a fairly clean signal, for noise easily degrades the 3.58-MHz color subcarrier and the color-difference signals. In both stereo-FM and color-TV, the additional information is multiplexed on the main carrier at a lower level than main-channel information, making it more susceptible to interference. Also, stereo-FM and color-TV receiver bandwidths are usually greater than those of mono-FM and black-and-white TV. The greater the bandwidth of any system, the more susceptible to noise that system is.

In the days of only mono-FM and black-and-white TV considerable lead-in loss was tolerated. Ghosts and noise weren't so noticeable. Today, unless you don't plan to enjoy stereo or color, you should install lead-in to handle both.

Fig. 1. Common types of lead-in include (A) flat twin-lead, (B) coaxial cable, and (C) shielded twin-lead cable.

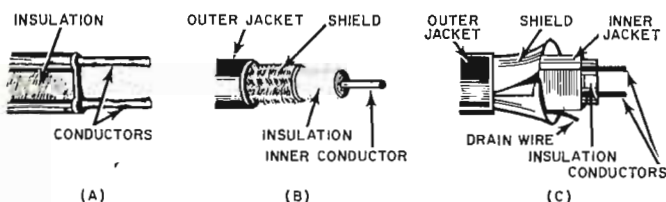

What Kind to Use?

By THOMAS R. HASKETT

U.h.f.-TV signals also make stringent demands on lead-in. V.h.f.-TV signals range from 54 to 216 MHz, while the u.h.f. band runs from 570 to 890 MHz. Since lead-in losses increase with frequency, this means that some types will work satisfactorily at v.h.f., but not at u.h.f.

Nearly every part of the country has at least one u.h.f. station on the air, and more are coming on every month. By federal law, all new TV receivers sold in interstate commerce must be capable of receiving both v.h.f. and u.h.f. Therefore, any new antenna installation should be all-channel.

Basic Lead-in Types

The most common type of TV-FM lead-in for many years has been ordinary *flat twin-lead*, as shown in Fig. 1A. It has a characteristic impedance of 300 ohms, to match the impedances of most antennas and receivers. It is balanced to ground (that is, neither side is grounded) and unshielded.

Less popular until recently is *coaxial cable* (Fig. 1B). Its impedance is in the range of 72-75 ohms. Since few antennas and receivers can match this impedance, transformers are usually required at both ends of the cable, to match the 300-ohm terminals. Coax is unbalanced (the outside conductor is grounded) and shielded. (Since the matching transformer used with coax converts a *balanced* line to *unbalanced*, it's often called a *balun*.)

More recently, a lead-in has been developed which combines the best feature of both twin-lead and coax. Called *shielded twin-lead* (Fig. 1C), it has 300-ohm impedance, is balanced to ground, and is also shielded.

As Fig. 2 shows, there are differences between coax and the two types of twin-lead in the distribution of the electromagnetic and electrostatic lines of force which surround the

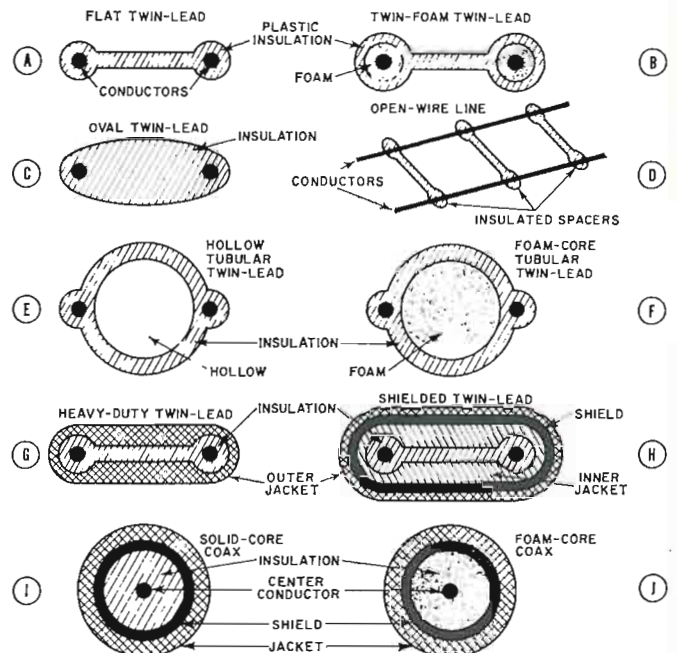
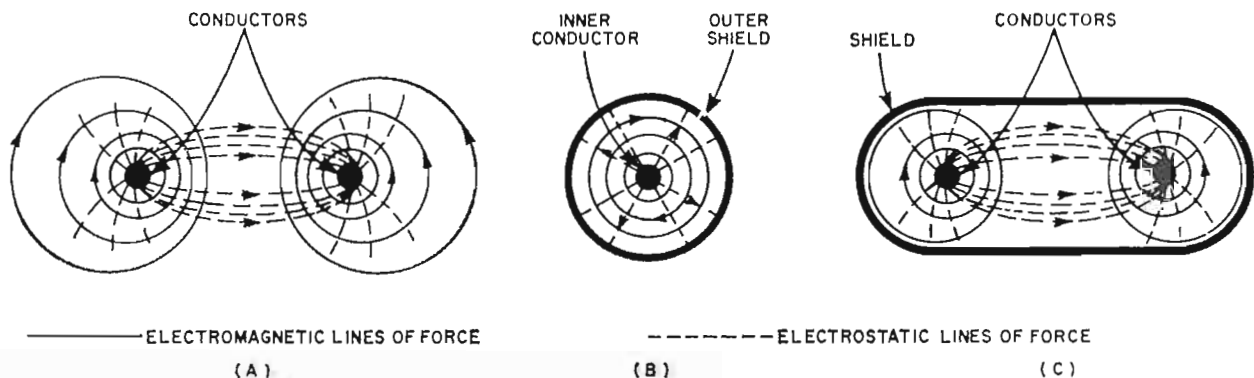

Fig. 3. Cross-sections of various types of lead-in.

conductors. These lines are produced by the current and voltage of the signal moving through the lead-in, and if the lines are disturbed, the signal may be impaired.

In ordinary twin-lead (Fig. 2A), many of the lines of force extend away from the conductors, which is why you cannot

Fig. 2. Magnetic fields (electromagnetic lines of force) and electric fields (electrostatic lines of force) in (A) flat twin-lead, (B) coax cable, and (C) shielded twin-lead.



Type of Lead-in	Signal losses in dB per 100 feet at:		
	100 MHz	500 MHz	900 MHz
Unshielded 300-ohm twin-lead			
Open-wire	0.5	—	—
Oval	0.9	2.6	3.9
Foam-core tubular	1.1	3.0	4.3
Flat	1.1	3.0	4.5
Twin-foam	1.1	3.5	4.5
Heavy-duty	1.2	3.5	5.1
Shielded			
300-ohm twin-lead	2.5	5.4	7.7
75-ohm foam coax	2.7	6.4	8.0
75-ohm RG-6/U coax	2.7	6.4	8.4
75-ohm RG-59/U coax	3.8	8.5	12.0

Table 1. Lead-in comparison by signal loss at the various frequencies indicated, under ideal conditions.

run twin-lead near metal objects. Coax overcomes this difficulty (Fig. 2B), as most of the lines are concentrated within the shield. The same is true of shielded twin-lead (Fig. 2C).

But there is a significant difference between coax and shielded twin-lead, regarding construction and performance. There are only *two* conductors in coax. In most types the outer conductor is a woven metallic braid; in others, it is a solid sheet of metal foil. The foil is slightly more effective as a shield. But since there are only two conductors, the shield carries current, which means that any interference is present in the signal circuit.

In shielded twin-lead, on the other hand, there are *three* conductors. The two inner conductors carry the signal and nothing more. The outer shield carries only interference. To install shielded twin-lead properly, you should tie the shield and drain wire to chassis or ground at the receiver only, and let it float at the antenna. Any interference picked up by the shield is thereby drained to ground at one end only, and doesn't get into the signal circuit.

Shielded twin-lead, then, is somewhat more immune to noise and spurious r.f. pickup than ordinary coax. This feature can be useful in high-noise locations.

Comparison of Lead-in Types

A number of different types of lead-in are available today. Fig. 3 shows cross-sections of these types.

Flat twin-lead (A) has been the most common type for many years because it's inexpensive. The conductors are surrounded by a polyethylene plastic insulator, which is available in either of two colors. Clear or white twin-lead is usable only indoors, where it blends with wall baseboards. It can't be used outdoors for the ultraviolet in sunlight rapidly deteriorates the poly. Brown twin-lead lasts longer outdoors, as the color keeps the ultraviolet light out. In *twin-foam twin-lead* (B), a core of foam poly surrounds each conductor. Foam poly is simply a mixture of polyethylene and air bubbles.

Since air has lower dielectric losses than poly, foam twin-lead has less loss than solid poly.

Oval twin-lead (C) was designed to keep contaminating moisture, soot, etc., farther from the lines of force surrounding the conductors. *Open-wire line* (D) has insulating spacers which maintain the conductors at the proper distance and keep the line impedance constant. Since the dielectric is chiefly air (except for the spacers), open-wire line has the lowest losses of all—at least when the insulators are clean and dry.

Hollow tubular twin-lead (E) is also designed to keep contaminating deposits away from the area between the conductors. The plastic insulator is formed in a tube, and since the core is hollow, the dielectric is mainly air. Unfortunately the hollow tube gathers moisture, which increases losses. In an effort to overcome this disadvantage, *foam-core tubular twin-lead* (F) was developed. The foam core gathers very little moisture.

Heavy-duty twin-lead (G), which is also called "jacketed" or "encapsulated," is surrounded by a tough, plastic, insulating jacket which resists the effects of weather and soot. *Shielded twin-lead* (H), as previously described, contains two conductors with insulation between, covered with a metal shield, and covered over-all with a tough, weather-resistant jacket.

Solid-core coax, at (I), as its name implies, has solid poly between the center conductor and the outer conductor (shield). Two types—RG-59/U and RG-6/U—are suitable for home installations; RG-6/U is slightly larger and has less loss. *Foam-core coax* (J) has an air-bubble-filled core which reduces losses. Most coax is covered with a weather-resistant, polyvinyl-chloride jacket.

Comparison by Signal Losses

Table 1 compares the various lead-in types by signal losses, at three frequencies. 100 MHz is roughly the middle

Type of Lead-in	Signal losses in dB at:		
	100 MHz	500 MHz	900 MHz
Shielded 300-ohm twin-lead	3	6	8
Heavy-duty 300-ohm twin-lead	5	8	9.5
Foam or RG-6/U coax, with two transformers	5	8.5	10
RG-59/U coax, with two transformers	7	11	16
Foam-core tubular 300-ohm twin-lead	10.5	16	20
Flat 300-ohm twin-lead	25	>35	>35

Table 2. Lead-in comparison by signal loss for a typical home installation. Naturally, these figures are only very approximate and will vary widely depending on the particular installation.

of the FM and the v.h.f. TV bands; 500 MHz is near the bottom, and 900 MHz near the top, of the u.h.f. TV band.

As mentioned before, open-wire lead-in has the lowest loss of any lead-in, roughly 1/4th of the lossiest type at 100 MHz, if it can be properly installed. Exact figures were not available at 500 and 900 MHz for open-wire, but average losses are around 2 dB for u.h.f. But open-wire lead-in is seldom used for TV or FM reception. It is difficult to install, not the least expensive, and highly susceptible to noise pickup, as well as losses if installed close to loss-inducing objects. It won't withstand weather conditions: you get a nice picture on a clear, dry day, but you may lose the signal when it rains or snows. Years ago, if the receiver were a great distance from the antenna, open-wire line was the only solution; any other type of lead-in would attenuate the signal too much. Today, you can use a mast-mounted preamplifier and conventional twin-lead or coax.

Losses for the other unshielded types are very similar. Unshielded-line losses increase roughly three times at 500 MHz, and roughly five times at 900 MHz. (Hollow tubular twin-lead isn't shown because it has been largely superseded by foam tubular type.)

Note that shielded lead-in losses are generally two to three times those of unshielded. But losses of shielded types don't increase as rapidly with frequency as those of the unshielded types. RG-59/U is the worst offender. With losses of 12 dB at 900 MHz, it is the least desirable in all-channel installations.

But the figures given in Table 1 were derived by measuring the various lead-in types under laboratory conditions, when the cables were dry and clean and removed from nearby objects. What happens to the various types at a typical home installation? The lead-in is run through stand-off insulators, perhaps routed through walls and near metal gutters or a.c. lines, and exposed to rain, snow, soot, and possibly salt spray. Inside the house, the lead-in may even be attached to walls with metal staples. All these factors cause greater losses in some types of lead-in than in others.

Table 2 compares the various types by losses in a typical installation. Shielded 300-ohm twin-lead has the least loss, followed by 300-ohm heavy-duty twin-lead. Foam-core coax isn't bad. All three are usable at u.h.f. Ordinary RG-59U 75-ohm coax works fairly well at 100 MHz, poorly at 500 MHz, and badly at 900 MHz. Foam-core tubular and flat 300-ohm twin-lead don't work as well at any frequency in this particular case, although foam-core tubular is better than regular flat twin-lead. Naturally, these figures will vary widely, depending on the kind of installation.

Coax suffers from an additional disadvantage in the typical installation. Very few antennas and receivers will work directly with 75-ohm coax. Thus you must use matching transformers, which add 2 or 3 dB of loss to the over-all cable figure. Table 2 coax-loss figures include approximately 2 dB of balun loss.

Noise Immunity and Durability

An unshielded line is more susceptible to interference pickup than a shielded one. Thus most coax picks up less interference than most twin-lead. But twin-lead is balanced to ground, avoiding hum pickup more than coax, which is unbalanced to ground. This disadvantage partially offsets the noise immunity of coax. Shielded twin-lead is both balanced to ground and shielded.

Some flat twin-lead isn't very durable, because the insulation deteriorates from the effects of the weather. When this happens, the insulation may fall apart, changing conductor spacing and line impedance. Standing waves are produced, causing ghosts on TV and loss of separation in stereo-FM. Oval and tubular twin-lead are a bit more immune than flat to such deterioration. The most immune types are heavy-duty and shielded twin-lead, and most coax. They are encapsulated in material impervious to weather and contamination.

Type of Lead-in	Approx. price per 100 ft
Unshielded 300-ohm twin-lead	
Flat	\$1.70
Hollow tubular	2.50
Heavy-duty	2.63
Open-wire	3.27
Twin-foam	3.68
Foam-core tubular	4.65
Oval	5.35
Shielded	
75-ohm RG-59/U coax	5.58
75-ohm foam coax	6.07
300-ohm twin-lead	10.15
75-ohm RG-6/U coax	16.80

Table 3. Comparison of various lead-ins by price. The price varies somewhat depending on quality and source.

To run ordinary flat twin-lead from antenna to receiver, you have to use stand-off insulators every 5 feet or so, and pull the line taut. Flat twin-lead whips easily in the wind and this flexing may break the conductors, requiring you to replace the line. It is also a good idea to twist the twin-lead in order to minimize noise and signal pickup.

If you use an ordinary metal-ring stand-off, you bring metal near the twin-lead, possibly causing ghosts. It's better to use all-poly-head types, which don't surround the line with metal. Also, you must run twin-lead carefully to avoid gutters and rain downspouts, for the same reason. You must likewise be careful when running flat twin-lead through the house wall so that it does not come too close to pipes and electrical wiring.

Oval and tubular twin-lead aren't much better than flat in this respect.

All shielded lead-in types are inherently easy to install, simply because you can run them nearly anywhere with no deleterious effects. The shield prevents nearby metal objects from disturbing line impedance, and minimizes noise pickup. You can use any type of stand-off to hold the line, and you can even tape it to the antenna mast, or run it inside pipe or conduit, which you should not do with most twin-lead. You must not deform shielded line—or any other type, for that matter. When you deform the line you change conductor spacing and you may possibly reduce signals and create ghosts.

Comparison by Price

After comparing various lead-in types on the basis of how well they perform, there remains the matter of price. There isn't much point in paying more than you have to, for your particular installation.

Table 3 compares the various lead-in types by price. The least expensive is flat twin-lead. Since most of the other types perform better, they cost more. Shielded types generally cost more than unshielded. RG-6/U, the most expensive, costs nearly 10 times as much as flat twin-lead.

Just as you cannot buy lead-in solely for its loss figure, or for its noise immunity, you cannot simply buy for price. You should consider all the previous criteria before making a choice. Even with flat twin-lead there are various qualities of insulation, several conductor sizes, and several conductor types (copper or copper-coated steel, for high strength) to choose from.

Over-all Lead-in Comparison

Table 4 shows an over-all comparison of six lead-in types, assuming a 100-foot run from antenna to receiver, some snow or rain, soot or other contamination, and a few metal objects and wiring near the lead-in.

Type of Lead-in	dB Losses @ 900 MHz	Noise Immunity	Durability, Contamination Immunity	Approx. Total Cost
Shielded twin-lead	8.0	Excellent	Excellent	\$10.15
Foam coax	8.5	Good	Excellent	12.25*
RG-6/U coax	10.0	Good	Excellent	22.98**
Heavy-duty twin-lead	9.5	Poor	Excellent	2.63
RG-59/U coax	16.0	Good	Excellent	11.76*
Foam tubular twin-lead	20.0	Poor	Good	4.65

*Includes cost of two matching transformers, average total price \$6.18

Table 4. Over-all comparison of a number of lead-in types for a typical 100-foot installation.

Shielded twin-lead is preferred in most installations. Its only drawback is price, which is moderate compared to the least and most expensive shown in the table. Shielded twin-lead has the lowest loss at u.h.f. under poor outdoor conditions, has excellent noise immunity, durability, and contamination immunity. It is also easy to install.

Foam coax is also good. The cost figure shown in Table 4 is a bit higher than for shielded twin-lead because it includes the cost of two baluns.

RG-6 U has only fair performance and is more than twice as expensive as shielded twin-lead. Thus it doesn't seem very desirable for a home installation.

Heavy-duty twin-lead is very inexpensive and durable, with excellent contamination immunity and moderate losses at u.h.f. in a typical installation. But it has poor noise immunity. If station signals are strong and interference and noise minimal at your location, heavy-duty twin-lead is probably a very good bet.

RG-59/U coax costs about the same as shielded twin-lead and performs as well, except it has less noise immunity and greater losses at u.h.f.

Similarly, foam tubular twin-lead has higher u.h.f. loss and is also susceptible to noise pickup.

Table 4 doesn't show the other lead-in types previously discussed, because they do not usually perform quite as well

in a stereo-FM, color-TV, all-channel installation. Oval, twin-foam, hollow-tubular, and flat twin-lead usually have higher u.h.f. losses in a typical installation, and are susceptible to interference pickup.

Although price is a factor in lead-in choice, don't forget one thing: The user has already invested \$300 to \$600 or more in a color-TV receiver; perhaps \$30 to \$60 in an antenna, and additional dollars for stereo-FM. Saving only a few dollars on lead-in cost may not be wise, for then the lead-in may be the weakest link in your equipment chain.

Antenna Preamplifiers and Multiset Couplers

In a fringe area, a high-gain antenna often picks up enough signal to provide a good picture or FM sound. But if the antenna is up on a tower, the downlead run may be long enough to negate the antenna advantage through line loss. And if you have noise and/or weather problems, the only solution is a mast-mounted preamplifier driving shielded line.

The preamplifier (or booster) is even more useful if you have more than one TV or FM receiver driven by the antenna, because to drive several sets you must connect them through multiset couplers which introduce additional signal losses. In this case, an amplified booster may be located at the point where the lead-in enters the house and individual lead-in runs made to the separate receivers. ▲

A listing of some representative lead-in types along with their manufacturers and catalogue designations.

Unshielded, 300-ohm, flat twin-lead Alpha 5150 Amphenol 214-056 Belden 8225 Columbia 1010 Lafayette 32T8912 Winegard 8200	Unshielded, 300-ohm, open-wire lead-in Allied 11C1473 Lafayette 32T3610
Unshielded, 300-ohm, twin-foam twin-lead Allied 11C1657 Columbia 5790 Durafoam Lafayette 32T3604	Shielded, 72-75-ohm coax, RG-59/U Alpha 9810 Amphenol 21-025 Belden 8241 Columbia 5750 Dearborn 59/U Lafayette 32T1715
Unshielded, 300-ohm, oval twin-lead Belden 8235	Shielded, 72-75-ohm foam coax, RG-59/U Alpha 9820 Amphenol 621-186 Belden 8228 Duofoil Columbia 1112 Dearborn 59/U Fmc CX-283-100 Jerrold Coloraxial Lafayette 32T3134 Winegard 2700
Unshielded, 300-ohm, hollow-core tubular twin-lead Columbia 1555 Lafayette 32T3608	Shielded, 72-75-ohm foam coax, RG-6/U Alpha 9006A Amphenol 21-330 Belden 8215 Winegard 2800
Unshielded, 300-ohm, foam-core tubular twin-lead Belden 3275 Celluline	Shielded, 300-ohm twin-lead Belden 8290
Unshielded, 300-ohm, heavy-duty twin-lead Alpha 5153 Amphenol 214-103 Belden 8230 Weldohm Belden 8285 Permohm Columbia 5050 Permaline Lafayette 32T3605	

Results of Japanese Tests on Color-TV Sets Made Public

By JAMES YAGI

OF the thirteen Japanese-made color-TV sets tested, *Japan Victor Co. (JVC)* and *National (Matsushita)* received top "A" ratings in most of the technical and "use" categories checked by the Japan Consumers Association and reported recently in the national press.

The Association was established in 1961 with government backing to provide consumer protection. This particular investigation was the first official one on color-TV sets manufactured in Japan. The actual tests were made by government inspection teams from the Ministry of International Trade and Industry and the Ministry of Welfare.

All Pass X-Ray Test

One of the most significant findings of the tests was that in all thirteen sets the rate of harmful x-ray emission was far lower than the specified standard. X-ray emission from the Japanese TV sets was far below that of some U.S. brands which have been under fire recently. Emissions from the picture tubes were measured from 0.01-0.08 mR/hr, far below the 0.5 mR/hr of the Electric Code Specification Standard.

A quick look at the test results below show that some of the most widely known and popular makes rated comparatively low in performance. However, according to one of the manufacturers, this only indicates the stringency of the Japanese inspection standard rather than that his set is inferior compared to the international norm. ▲

Official results on thirteen 18" Japanese color-TV sets.

Brand	Model	Resolution	Conv.	White Color	Image Dist.	Ad-just.	Sound	Image Bright	Color Qual.
National	TK-1100D	A	A	A	A	A	A	B	A
Sharp	C-D3	B	B	A	B	B	B	B	B
Columbia	C-81A	B	B	A	B	B	A	B	B
Sanyo	CT-900	B	A	A	B	B	A	B	A
Fuji	CS-900	B	B	A	B	B	B	C	B
Mitsubishi	CK-806	A	B	A	B	B	B	B	B
JVC	C-838	B	A	A	A	A	A	A	B
Sony	C-100	B	C	A	A	C	C	C	C
Toshiba	CVU	B	A	A	A	B	B	B	B
Onkyo	BCK	A	B	A	B	C	C	B	B
Hitachi	CN-700C	B	A	A	B	B	B	A	B
General	CCF	B	A	A	B	B	B	A	B
NEC	CT-520	B	B	A	B	B	B	B	C

A = Excellent; B = Good; C = Substandard

Telex writes new specs on sensitivity and ruggedness in headphones.



the Communicator Series

HIGH SENSITIVITY AND LOW OPERATING POWER. The new Communicator Series of headphones is designed around a dramatic new driver unit that requires only absolute minimal operating power. This added efficiency allows for a substantial increase in sensitivity without any increase in distortion, making the Communicator Series the most sensitive and versatile headphones available today.

RUGGED. CONSISTENT PERFORMANCE. Unlike the soft aluminum or paper cones in most of today's headphones, the Communicator's rugged new cone is made of special material that will provide peak performance without being affected by temperature or humidity. This means that you get consistent, high quality performance, day in and day out, under the most demanding communications conditions.

For more information on Telex's new Communicator headphones, contact your nearest Telex dealer or write.



PRODUCTS OF SOUND RESEARCH
TELEX[®]
COMMUNICATIONS DIVISION
9600 Aldrich Avenue South
Minneapolis, Minnesota 55420

CIRCLE NO. 104 ON READER SERVICE CARD



DELTA will tell you *everything!*—Complete Specs including schematics!



MARK TEN[®] SCR

CAPACITIVE DISCHARGE IGNITION SYSTEM

Now discover for yourself the dramatic improvement in performance of your car, camper, jeep, truck, boat—any vehicle! Delta's remarkable electronic achievement saves on gas, promotes better acceleration, gives your car that zip you've always wanted. Find out why even Detroit has finally come around. In five years of proven reliability, Delta's Mark Ten has set new records of ignition benefits. No re-wiring! Works on literally any type of gasoline engine.

- ▲ Dramatic Increase in Performance and in Fast Acceleration
- ▲ Points and Plugs Last 3 to 10 Times Longer
- ▲ Promotes More Complete Combustion
- ▲ Up to 20% Mileage Increase (saves gas)

KIT FORM **\$2995**
12V ONLY

ASSEMBLED **\$4495**
ONLY ppd.

MODEL 3000 FET VOM

Delta now offers a compact, versatile, and extremely sensitive VOM which combines FETs and ICs for extreme accuracy. Compact (6½"W x 8"H x 3½"D), portable. Wt. 3¾ lbs.

IN KIT FORM: Feedback network with pre-selected components to eliminate all final calibration. Ready to use when assembled!

NEW DELTA FEATURES:

- ▲ Mirror scale 200 A D'Arsonval meter
- ▲ Integrated circuit (IC) operational amplifier for extreme accuracy
- ▲ FET input stage with current regulator
- ▲ Two stage transistor current regulator and Zener diode on OHMS for absolute stability and accuracy
- ▲ Voltage clippers for protection of input stage

- ▲ Fully temperature compensated for low low zero drift
- ▲ Ten turns ZERO and OHMS adjust potentiometers
- ▲ Epoxy glass circuit boards and metal case
- ▲ Enclosed switches
- ▲ Uses readily available type AA cells
- ▲ Uses standard test leads for maximum flexibility and ease of measurement
- ▲ 10 Megohms input impedance

ONLY **\$7495**
ppd.

Only **\$5995**
ppd.



COMPUTACH[®]

Delta, pioneers in CD ignition who produced the fabulous MARK TEN[®], now offer a precise computer-tachometer which obsoletes any type tachometer on the market today! You achieve unbelievable accuracy in RPM readings due to the advanced, solid-state electronic matched components used in the computer, coupled with the finest precision meter in the world. Works on all 2, 3, 4, and 6 cylinder 2 cycle and with 4-6-8 cylinder—4 cycle 12 volt engines.

- ▲ 0-8000 RPM range
- ▲ Perfect linearity—zero parallax
- ▲ Adjustable set pointer
- ▲ Wide angle needle sweep
- ▲ Translucent illuminated dial
- ▲ Chrome plated die-cast housing
- ▲ All-angle ball & socket mounting
- ▲ Use it with ANY ignition system
- ▲ Meter: 3½" dia. X 3¾" deep
- ▲ Calibration kit included, no test eqpt. needed.

An exclusive computer-tachometer for precise RPM measurement in easy-to-build kit form! **\$2995** ppd.

KIT FORM ONLY

DP 9-B

DELTA: Please send me literature immediately.

I am enclosing \$_____ for items checked.

- Mark Ten SCR Kit Assembled
- Model 3000 FET VOM Kit Assembled
- Computach (Kit only)

Please ship immediately.

Name _____

Address _____

City, State _____ Zip _____

*My car is (Model) _____ (Year) _____

EW



DELTA PRODUCTS, INC.

P.O. BOX 1147 • GRAND JUNCTION, COLORADO 81501

TWO NEW BELL RINGERS FROM DELTA

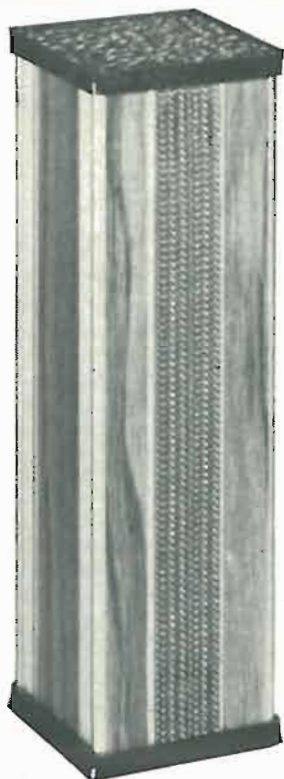

DELTALERT

Ultra Sonic Silent Sentry System

The all new economical-to-use DELTALERT, is more than a total motion detection and intrusion alert system. Use it as a convenience item to turn on lights, ring bells, alarms or monitor any area, indoors or out. Merely plug the system into any wall socket and plug the light, bell or alarm into the back of the unit. DELTALERT's **Extra Feature** variable sensitivity control and adjustable timing features provide you the most advanced sentry system on the market. Unit comes in handsome walnut finish, complete with 110-130V drop cord.

SPECIFICATIONS:

- ▲ Ultrasonic Frequency: 35 KHZ
- ▲ Area Coverage: 10-30 feet (depending on environmental conditions such as shape of area)
- ▲ Controls: On-Off Switch; Built in Timer; Variable Sensitivity Control
- ▲ Output: 110-130V at 1 Amp.
- ▲ Power Requirements: 110-130V, 60 HzAC

ONLY **\$5995**
For Complete Unit, Ready to Use ppd.

HIGH VOLT ANALYST

Complete Auto Analyzer

Delta brings you a new concept in automotive tune-up — The High Volt Analyst. A unique and complete auto analyzer, it provides all the primary advantages of a scope and yet is completely portable.

SPECIFICATIONS:

- ▲ Accuracy — Tachometer $\pm 2\%$ of full scale (all ranges) • Dwell Meter $\pm 1\%$ (both ranges) • OHMS Scale $\pm 5\%$ • Low Voltage $\pm 2\%$ of full scale • High Voltage $\pm 5\%$ of full scale
- ▲ General — Fully protected meter circuit* • Size: 6½W x 8H x 3½D • Weight: 3¾ lbs.
- ▲ Ranges — DC Volts 0-15V, 15KV and 45KV • OHMS: 0-1 Meg. (10K center scale) • Dwell: 4, 6 and 8 cylinders • Tachometer: 0-1500 RPM, 6000 RPM

*Batteries (8 Type AA cells) included. Comes complete with standard lead set, a special probe, and high tension lead.

\$7995 ppd.
Assembled

\$5995 ppd
kit form



DELTA: Please send me literature immediately.
I am enclosing \$_____ for items checked.

- DELTALERT
 High Volt Analyst, Assembled
 High Volt Analyst, Kit form

Please ship immediately.

Name _____ Dept. EW

Address _____

City/State _____ Zip _____



DELTA PRODUCTS, INC.

P.O. BOX 1147 • GRAND JUNCTION, COLORADO 81501



JOHN FRYE

To a large extent the human body "runs by electronics." Nerve impulses and even muscular contraction are electronic in nature.

ELECTRONICS AND THE BODY

WHEN Matilda, the office girl at Mac's Service Shop, came in the door this frosty January morning stamping the snow off her boots, she found her employer still wearing his hat sitting at her desk catching up on some belated year-end book work. She went on back to the service department to hang up her coat and park her boots, but when she flipped on the lights she let out a piercing shriek that brought Mac on the run.

"What the—" he started to say, and then began to chuckle as his eyes followed her shaking finger to a full-size cardboard skeleton hanging on the outside of the clothes-closet door.

"If this is that knot-headed Irishman's idea of a joke, I'll burn out his filaments," Mac threatened.

"It's no joke," Barney's voice said from the doorway behind him. "Golly, Matilda, I'm sorry old Charlie there gave you a start. Last night I came down here to try out a couple of ideas on an intermittent portable TV that gave me fits yesterday afternoon, and I brought Charlie along so I could be boning up on my bones—if you'll forgive the expression—while I was waiting for the set to cut out. I decided to leave him here so I could keep reviewing for a big test on bones and muscles that is coming up the last of the week."

"Hey, what's this about bones and muscles?" Mac demanded. "I thought it was psychology you were taking over at the university."

"Not now," Barney said. "I'm taking anatomy this semester. Getting hooked on this education thing is kind of like looking up a new word in an unabridged dictionary. The definition almost always contains other new words you have to look up. I found out that I couldn't really understand the functioning of the mind without a knowledge of the body in which it operates. The idea that mental processes all take place inside the skull is a layman's concept. The brain must be nourished by blood pumped by the heart, supplied with oxygen taken in by the lungs, and fed with a constant flow of information from the entire nervous system. What affects any of these colors the thinking. So, to get the most out of my psychology I have to study anatomy. But I'm glad I did because I am finding out that the human body comes a lot closer to being electronically operated than I ever imagined."

"Are you sure you aren't just seeing what you want to see?" Mac asked. "I never think of much electronic activity going on inside the body."

The Nerve Impulses

"No I'm not," Barney denied. "Actually, it is only in the last quarter of a century that we have begun to understand the important part electrons and ions play in physiology. You may remember a nerve impulse is actually a travelling electro-chemical change that sweeps along a nerve fiber. This fiber can be pictured as a tube of membrane with a concentration of positive potassium ions inside and a concentration of sodium ions outside. These two concentrations result in a potential difference of about 85 millivolts across the membrane of a resting nerve fiber, the inside being negative with respect to the outside. The membrane is readily permeated by the potassium ions but not normally by the sodium ions.

"But when a point on a nerve fiber is stimulated, that small portion of the membrane suddenly becomes permeable to the sodium ions, and they rush to the less-positive inside so fast they produce an overshoot and make the inside of that portion of the membrane about 35 millivolts positive with respect to the outside. This is called 'depolarization,' which you can see is a bit of an understatement. Anyway, this local change in potential produces a change in the permeability of the adjoining membrane so that the impulse travels along the nerve fiber.

"Behind the travelling impulse, the 'sodium pump' forces the sodium ions back outside the membrane and restores the *status quo*. Once more the inside is negative with respect to the outside, and that portion of the membrane is again impermeable to sodium ions. The effect is sort of like dragging your finger along a piano keyboard. Each key is depressed beneath your moving finger, but it springs back up as your finger moves on to the next key."

"What you're saying is that all the nervous activity of the body is in a large part electronic," Mac suggested.

"That's right, but *myelinated* nerve fibers depend still more on electronic action. These are large fibers that have insulating myelin beads strung along the outside of the membrane about every millimeter. Between beads, at points called the nodes of Ranvier, the membrane is exposed and a typical membrane depolarization can occur; but the membrane depolarization at one such point does not spread beneath the adjacent section of myelin sheath. Instead, electrical current goes around outside the myelin bead to the next node, causing it to become depolarized also. In this way the impulse jumps from one node to the next, and this *saltatory conduction*, as it is called, is thought to have two advantages: (1) the leapfrogging action increases the velocity of conduction, for a large myelinated fiber conducts impulses at a velocity of 100 meters a second, while small unmyelinated fibers conduct them at only .5 meter per second; and (2) the saltatory conduction prevents the depolarization of large areas of the membrane and makes less work for the sodium pump, thus decreasing the energy needed for impulse transmission."

"Matilda's myelinated nerves must have been acting when she saw Charlie," Mac said with a teasing grin, "because it was only a fraction of a second after she flipped the light switch until I heard her scream."

"Never mind the wise cracks," Matilda said, turning red. "I'm convinced, Barney, that ions do more for the nervous system than pink pills, but what else do they contribute to the body's functioning?"

The Muscles Too

"They get into the muscle act, too," Barney continued. "A motor nerve impulse does not actually go into the muscle but stops short at a *neuromyal junction* on the muscle's exterior. This consists of the nerve ending, or *endplate*, and a small space between it and the plasma membrane of the muscle fiber. When an impulse reaches the endplate, the latter secretes a chemical called *acetylcholine* into the space beneath. This renders the plasma membrane permeable and

sodium ions flow in. If the influx is great enough to produce a sufficient endplate potential, an impulse is initiated that travels along the muscle fiber just as a nerve impulse travels along its fiber."

"Do the sodium ions make the muscle contract?" Matilda asked.

"No, but along with them calcium ions also enter the fiber, and it's believed the latter cause the actual contraction. You see a section of skeletal muscle fiber, called a *sarcomere*, consists of paralleled heavy *myosin* and thinner *actin* filaments interleaved much as if you took a bundle of large white soda straws and into each crevice between the white straws, at both ends, inserted two thinner colored straws, leaving the inserted ends a few inches apart. It's thought muscle contraction causes the actin filaments to slide in among the myosin filaments the way a piston slides into a cylinder. This shortening action of the muscle occurs, it is postulated, because the calcium ions react with adenosine triphosphate (ATP), the major chemical energy source of the body, so as to create an electrostatic attraction between the two kinds of filaments, making them slide together."

"Well," Mac observed, "you've made your case for nerves and muscles; but how about the bones? Doesn't electronics do anything for Charlie?"

Even the Bones

"But of course! When continued stress is applied to a bone, it enlarges and strengthens in such a way as to accommodate that stress. There is good reason to believe this occurs because the stress produces a piezoelectric effect in the bone just as it does in a crystal. This could occur at the junctions of hydroxyapatite crystals and collagenous fibers in the bone matrix. At any rate, electrically negative regions appear to be associated with bone formation and electrically positive regions with bone destruction. If old Charlie over there had been bow-legged as a child, the inside of his tibias would have been compressed and the outside stretched by supporting his body weight. This would have caused bone to be deposited on the insides and removed from the outsides over the years until he could end up with the nice straight gams he has now—and quit tugging at your miniskirt, Matilda!"

"If there's one thing I can't stand, it's a fresh kid," Matilda said, "and this is not a miniskirt. Take him in hand, Mac."

"Okay, Buster, is that the end of electronics in the body?"

"Oh by no means! Electrons play a very important part in the metabolism of the hundred trillion cells of the body, especially in the creation of energy from carbohydrates, proteins, and lipids. This involves the creation of ATP, the release of energy packets by the stepped breaking down of ATP, and the resynthesis

of ATP from the fragments and from food sources. I'm talking now about the Emden Myerhoff Scheme and the Krebs Cycle, both of which are pretty hairy unless you're a biochemistry major—which I certainly am not. But I know that the acts of storing chemical energy and freeing it for use by the muscles, nerves, and the cells themselves involve continuous complicated rearrangements of electrons and ions.

Biological Delay Line

"Oh yes! Before I shut up, I want to mention an interesting biological delay line that exists in the heart. As you probably know, the heartbeat is triggered by its pacemaker, the sinoatrial node in the upper or atrial chambers of the heart. The impulse spreads over the atrial walls, causing them to contract, and reaches the atrioventricular node, a channel of specialized tissue located at the junctions of the upper and lower chambers of the heart. This tissue conducts impulses about 1/2 as fast as tissue in the atrial walls, and since the atrial walls are separated from the ventricles by insulating tissue, the impulses must pass through the delaying A-V node. The result is the atria, the primer pumps, have time to complete their contractions before the major pumps, the ventricles, start their strong contractions."

"I knew if I waited long enough you'd get around to something I could talk on," Mac said. "Hewlett-Packard recently came out with what I'd call a second-generation heart-patient monitor, called an arrhythmia monitor, designed to detect and give warning of heart beat irregularities that occur *before* the onset of such life-threatening events as cardiac arrest or fibrillation. The instrument continuously and tirelessly examines electronically the electrical output of the heart for irregularities such as premature beats or widened QRS waves, both indications of ectopic beats, or beats not triggered by the S-A node. It counts and records these beats and sounds an alarm if they exceed a pre-set number in sequence or per minute."

"That's a good example of how knowledge of the electrical activity inside the body can be used to keep the body 'turned on,'" Barney observed. "But let me say this: that anatomy course has done a lot to reduce my ego. It's easy for a technician who keeps boning up—excuse me, Charlie!—on semiconductors, color TV, CATV, lasers, computers, holograms, and stereo broadcasting to mistake himself for a pretty smart cookie; but a single frustrating session in an anatomy lab watching the excised gastrocnemius muscle of a frog twitching under electrical stimulation and realizing how little he *really knows for certain* about what is going on in that tiny jumping muscle and its nerve cuts his bloated egotism down to size!" ▲

ALWAYS INSIST

ON

CQC*



*CONTROLLED
QUALITY
CRYSTALS

for your Communications

THE

"ON-CHANNEL"

CRYSTALS by

CRYSTEK



NOW YOU CAN

ZIP-ORDER

THE CQC CRYSTALS YOU WANT

Your electronics dealer has new, fast, direct-factory ZIP-Order Purchase Certificates to enable you to get CRYSTEK CB, Monitor or Amateur Controlled Quality Crystals mailed direct to you promptly. Ask about them.

CRYSTEK

formerly

TEXAS CRYSTALS

Div. Whitehall Electronics Corp.

1000 Crystal Drive
Fort Myers, Florida 33901

4117 W. Jefferson Blvd.
Los Angeles, California 90016

CIRCLE NO. 140 ON READER SERVICE CARD



ANOTHER SONAR FIRST!

**CRYSTAL CONTROLLED • BASE OR MOBILE
24 CHANNELS
FM MONITOR
RECEIVERS**

designed for POLICE, FIRE, MUNICIPAL DEPTS. Commercial, Industrial & Other Unlimited Uses NEW—SONAR EXCLUSIVE! 24 channel professional receivers, engineered to satisfy the most exacting requirements for the professional user. Features: unique turret switching design • Exceptional sensitivity and selectivity • Crisp audio sound • Narrow band operation • Noise free squelch • Solid state for reliable operation at high temperatures • Operates from 117VAC and 12VDC • Heavy gauge construction • Fits into smallest vehicle.

FR-2512 / FR-2513 \$169.95
(25-50MHz) / (150-175MHz)
Comes with AC and DC power cables, mounting bracket, less crystals. Crystals \$5.00 ea.

SONAR RADIO CORPORATION
73 Wortman Ave., Bklyn, N.Y. 11207
Please send information on Model FR2512/13 FM Monitor Receivers. Dept. 520

Name _____
Address _____
City _____ State _____ Zip _____

CIRCLE NO. 106 ON READER SERVICE CARD



**SONAR
AUTO-SCAN
FM MONITOR
RECEIVERS**

AUTOMATICALLY SCANS 8 PRE-PROGRAMMED CHANNELS—WITH PRIORITY CHANNEL FEATURE
designed for: Police, Fire & Municipal Depts. County, State & Federal Agencies, Commercial & Industrial Applications, Other unlimited uses A highly dependable performer with superior professional features. AUTO-SCAN searches and locks automatically on any of 8 pre-programmed channels. Priority Channel locks to the exclusion of other signals • Mobile Callbacks are heard because of carrier delay • Designed for rugged use over wide temperature range • Narrow band operation • Operates from 117VAC and 12VDC, negative or positive ground • Noise free squelch • 8 crystals.

FR-2514 / FR-2515 \$189.95
(25-50MHz) / (150-175MHz)
Comes with AC and DC power cables, less crystals. Crystals \$5.00 ea.

SONAR RADIO CORPORATION
73 Wortman Ave., Bklyn, N.Y. 11207
send information on Model FR2514/15 AUTO-SCAN FM Monitor Receivers. DEPT. 520

Name _____
Address _____
City _____ State _____ Zip _____

CIRCLE NO. 100 ON READER SERVICE CARD
58

EW Lab Tested
(Continued from page 6)

reduces noise on weak stereo signals at the sacrifice of some separation but without affecting frequency response.

With its advanced design, one would expect the KT-7000 to be a good performer, and it is. The IHF usable sensitivity was a high 1.8 microvolts with steep limiting and a measured harmonic distortion of only about 0.5 percent. This is the residual level of our signal generator. Frequency response was as flat as we have ever measured on an FM tuner, within ± 5 dB from 30 to 15,000 Hz. Stereo separation clearly showed the benefits of the superior i.f. bandpass characteristics of the tuner, being exceptionally uniform over a wide frequency range. Separation was between 25 and 32 dB from 30 to 8000 Hz, and was still a good 15 dB at 15,000 Hz.

In listening tests, we were immediate-

ly aware of the superior qualities of the KT-7000. It has a definition and clarity that are matched by very few tuners we have used, and both are distinctly superior to those of many tuners whose measured performance does not differ greatly from that of the KT-7000. The interstation-noise muting works well, although there is still a slight burst of distorted modulation just as the circuits switch on or off. The selectivity was most impressive, permitting us in many cases to receive clear signals from weak stations only 200 kHz removed from much stronger stations. Credit this also to the crystal i.f. filters.

Price of the Kenwood KT-7000 is only \$249.95 including walnut side panels. Most FM tuners that are comparable to the KT-7000 are considerably more expensive, and even if they include AM coverage, it is frequently of inferior quality. On the other hand, the AM sound of the KT-7000 was quite acceptable to our "hi-fi-tuned" ears. ▲

Scott S-15 Speaker System

For copy of manufacturer's brochure, circle No. 2 on Reader Service Card.

RECENT H. H. Scott "controlled-impedance" speaker systems have been designed especially for transistor power amplifiers. Most such amplifiers cannot drive a load of much less than 4 ohms without either damaging the output transistors or tripping their protective circuits. Some speaker systems with a nominal 8-ohm rating actually present a much lower impedance at certain frequencies. Scott's design limits the minimum impedance of the complete speaker systems, over its full frequency range, to a safe value.

The Scott S-15 is typical of that company's new models. It is a medium-priced bookshelf system, measuring 23 1/4" wide x 11 1/4" high x 9" deep. Its compact size and its 24 1/2-pound weight make it usable on bookshelves without reinforcement of the shelf supports.



The S-15 is a three-way system. The 10-inch acoustic suspension woofer, with a 26-Hz free-air resonance, handles fre-

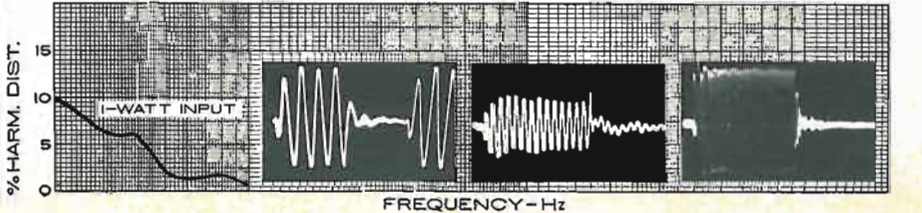
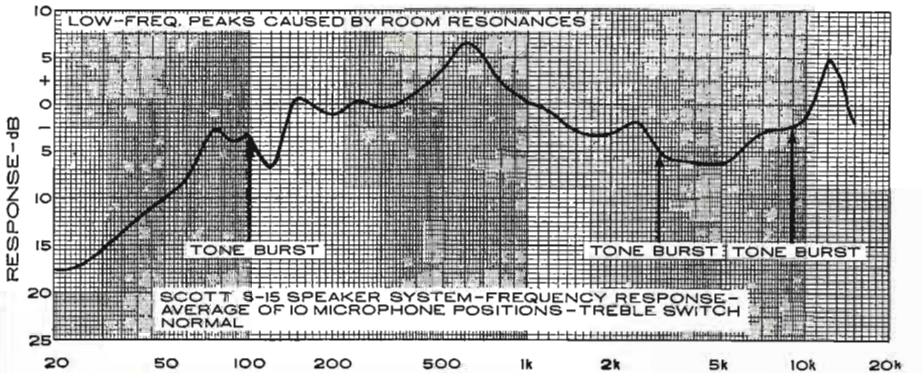

quencies up to 750 Hz. The middle frequencies are radiated by a 4¹/₄-inch cone speaker. Above 3800 Hz, a 3-inch cone speaker takes over. A three-position toggle switch in the rear of the cabinet provides a moderate increase or decrease of the output level above 750 Hz.

In our tests, we averaged the speaker's output as measured at ten locations in the room to produce a single response curve. There were moderate peaks at 600 and 12,000 Hz. (*The latter has occurred with a number of other speakers and may be caused by diffraction effects with the particular pickup microphone being used.—Editor*) These could have been at least partially corrected with the high-frequency level switch in its middle position. The low-frequency response fell off at 6 dB per octave below 70 Hz. The averaged measured frequency response of the S-15 was ± 6.5 dB from 65 to 15,000 Hz. This is typical of many moderately priced speaker systems (and some costing considerably more) we have measured in the same room.

Although the low-frequency output was not particularly strong, the harmonic distortion at a 1-watt drive level was very low—less than 2 percent down to 50 Hz, 6 percent down to 30 Hz, and 10 percent at 20 Hz. Probably the output at the lowest frequencies would have been enhanced with corner mounting of the speaker, but we tested it in a mid-wall location such as would normally be used with a system of this type. Because of its low distortion in the bass, the S-15 is potentially an excellent low-frequency reproducer, and it could be satisfactorily equalized by an amplifier whose tone controls provide moderate bass boost without affecting the higher frequencies. Although the S-15 does not have the palpable lows of some comparably priced speakers, we believe its sound would satisfy almost anyone except a pipe-organ buff. The absence of over-emphasis in the lower and middle bass enables it to reproduce the human voice with greater naturalness than many speakers that favor the bass.

The tone-burst response of the S-15 was outstandingly good, except for a single frequency in the vicinity of 1200 Hz, where we found some ringing. Occurring as it did at one frequency only, it could not be heard when listening to program material.

The Scott S-15, being relatively small, light, and unadorned, may not look like a \$120 system to admirers of cabinet work. However, be assured that it definitely performs like one. Its sound is clean and balanced, and it can be listened to for hours without strain or fatigue. This is a necessary quality in any good speaker system—and the S-15 passes this test with ease.

The S-15 is used in Scott's "top-of-the-line" 2505 compact music system (\$530). It sells separately for \$119.95. ▲

This advertisement is neither an offer to sell, nor a solicitation of an offer to buy, any of these securities. This offering is made only by the Prospectus.

October 30, 1969



275,000 Shares

Lea-Ronal, Inc.

Common Stock
(\$1 Par Value)

Price \$21.50 per Share

Copies of the Prospectus may be obtained in any State from only such of the undersigned as may legally offer these securities in compliance with the securities laws of such State.

Walston & Co., Inc.

Allen & Company <small>Incorporated</small>	Bache & Co. <small>Incorporated</small>	Bear, Stearns & Co.	Clark, Dodge & Co. <small>Incorporated</small>
Dominick & Dominick <small>Incorporated</small>	Francis I. duPont, A. C. Allyn, Inc.	Goodbody & Co.	
E. F. Hutton & Company Inc.	Shearson, Hammill & Co. <small>Incorporated</small>	Shields & Company <small>Incorporated</small>	
Blair & Co., Inc.	Butcher & Sherrerd	Courts & Co.	
H. Hentz & Co.	Hirsch & Co., <small>Incorporated</small>	C. E. Unterberg, Towbin Co.	

CIRCLE NO. 102 ON READER SERVICE CARD

ABOUT YOUR SUBSCRIPTION

Your subscription to ELECTRONICS WORLD is maintained on one of the world's most modern, efficient computer systems, and if you're like 99% of our subscribers, you'll never have any reason to complain about your subscription service.

We have found that when complaints do arise, the majority of them occur because people have written their names or addresses differently at different times. For example, if your subscription were listed under "William Jones, Cedar Lane, Middletown, Arizona," and you were to renew it as "Bill Jones, Cedar Lane, Middletown, Arizona," our computer would think that two separate subscriptions were involved, and it would start sending

you two copies of ELECTRONICS WORLD each month. Other examples of combinations of names that would confuse the computer would include: John Henry Smith and Henry Smith; and Mrs. Joseph Jones and Mary Jones. Minor differences in addresses can also lead to difficulties. For example, to the computer, 100 Second St. is not the same as 100 2nd St.

So, please, when you write us about your subscription, be sure to enclose the mailing label from the cover of the magazine—or else copy your name and address exactly as they appear on the mailing label. This will greatly reduce any chance of error, and we will be able to service your request much more quickly.

FOREDOM MINIATURE POWER TOOLS

for the Professional Technician

Drill, grind, debur, polish, sand, cut, drive screws and nuts. No other tools can perform the range of intricate, precision operations you can do with FOREDOM.



SEND FOR COMPLETE MINIATURE POWER TOOL CATALOG 250.



THE FOREDOM ELECTRIC COMPANY
A DIVISION OF BLACKSTONE INDUSTRIES, INC.
Bethel, Connecticut 06801

CIRCLE NO. 136 ON READER SERVICE CARD

We pack your electronics course with kits to make your training fast. You'll enjoy every minute of it.



Your NTS success package

Choose a career in electronics: Computers. Color TV Servicing. Automation. Communications. Whatever the field, NTS has a complete home-study package to get you to the top *faster*. 10 thorough training courses. Each includes *everything* to give you the *working* knowledge required of successful technicians.

NTS Project-Method Training is the practical way to learn elec-

tronics. It's a proven combination of lessons and the best professional kit equipment available. NTS provides the *biggest selection of kits ever offered in home-study . . . all at no extra cost*. You'll construct these exciting kits to fully understand electronic circuits, components, and concepts. Our Project-Method lets you build skills by putting theory into practice . . . by working with your hands, as well as your head.

The NTS "learn and practice" approach makes training at home really easy. All it takes is a few hours a week . . . whether you're starting from scratch or in advanced courses. This is the all-inclusive success package that put thousands of men into the best paying jobs . . . or into their own business. If "just a living" isn't good enough for you, now is the time to get something better going for you!

NTS COMPUTER ELECTRONICS

This is the future. And it's happening now. The number of computers will *increase many times* in the next few years.

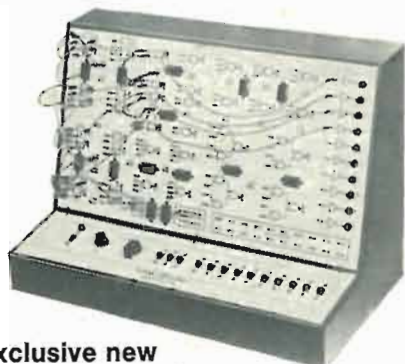

Exclusive new Compu-Trainer®

NTS offers a solid grounding in computer operation, wiring, data processing and programming. One of the 10 important kits included is our exclusive Compu-Trainer®. It's a fully operational computer logic trainer — loaded with integrated circuits — the first ever offered in home study. It introduces you quickly to how, what, when and why of computers . . . from theory to practical servicing techniques. This unit is capable of performing 50,000 operations per second. And it's sent at no extra cost.

NTS COLOR TV SERVICING

This is a broad, easily understood

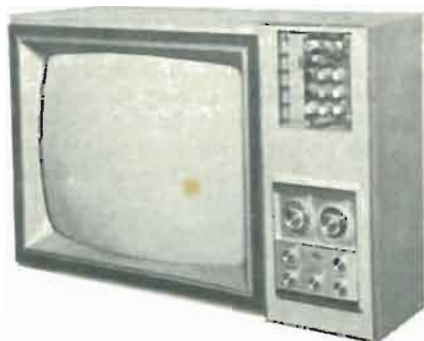

**COLOR TV
295 SQ. IN. PICTURE**

program designed to make you a complete home-entertainment service technician. Included, at no extra cost, is a color TV that has more features than any

set on the market. You also learn all about stereo, hi-fi, multiplex systems, and become a specialist in Color TV Servicing. Kits also include AM-SW radio, solid-state radio, field-effect transistor volt-ohmmeter, electronic tube tester,

NTS AUTOMATION/ INDUSTRIAL ELECTRONICS

You're trained in the "push-button" electronics that keep industry going and growing . . . from relay type controls to highly advanced systems essential to production. You receive 16 kits including a 5" wide band oscilloscope, and the new NTS electronics lab: a fascinating NTS exclusive experimental laboratory. A complete workshop which makes you familiar with solid-state, miniature, and integrated circuits.



**5"
Oscilloscope**

NTS ELECTRONIC COMMUNICATIONS

The use of 2-way radio systems in private and commercial applications is skyrocketing. NTS prepares you for the big-money opportunities in the field of transmitting and receiving equipment. *Your tuition will be refunded in full if you cannot pass the FCC exam for a 1st Class Commercial Radio-Telephone License within*



5 Watt AM Transmitter & Receiver

six months after successfully completing this course. You build valuable kits including Amateur-Phone 6 Meter VHF Transceiver, solid-state Radio, and a field-effect transistor volt-ohmmeter.

CLASSROOM TRAINING AT LOS ANGELES

You can take classroom training at Los Angeles in sunny Southern California. NTS occupies a city block with over a million dollars in facilities devoted exclusively to technical training. Check box in coupon.

NATIONAL TECHNICAL SCHOOLS

World-Wide Training Since 1905
4000 South Figueroa Street
Los Angeles, Calif. 90037, U.S.A.

APPROVED FOR VETERANS

Accredited Member: National Association of Trade and Technical Schools, National Home Study Council.

**TODAY, MAIL
COUPON
FOR FREE
COLOR
CATALOG
AND SAMPLE
LESSON.**



NATIONAL TECHNICAL SCHOOLS
4000 S. Figueroa St., Los Angeles, Calif. 90037

Please rush Free Color Catalog and Sample Lesson, plus information on field checked below. No obligation. No salesman will call.

- MASTER COURSE IN COLOR TV SERVICING
- COLOR TV SERVICING
- MASTER COURSE IN TV & RADIO SERVICING
- PRACTICAL TV & RADIO SERVICING
- MASTER COURSE IN ELECTRONIC COMMUNICATIONS
- FCC LICENSE COURSE
- MASTER COURSE IN ELECTRONICS TECHNOLOGY
- INDUSTRIAL AND AUTOMATION ELECTRONICS
- COMPUTER ELECTRONICS
- BASIC ELECTRONICS

Name _____ Age _____

Address _____

City _____ State _____ Zip _____

Check if interested in Veteran Training under new G.I. Bill.

Check if interested ONLY in Classroom Training at Los Angeles. Dept. 240-010

WAVE FORM ANALYSIS & PEAK FM MODULATION



all for LESS MONEY!

The Lampkin 205A FM Modulation Meter accurately indicates PEAK modulation on mobile transmitters. To shoot trouble visually, use your own general-purpose oscilloscope at the 205A rear jack output. This makes a low-cost, highly effective test combo — and a well-rounded shop — all for less money.

Lampkin pioneered the PEAK voltmeter for FM modulation indication.

Like to see the complete specs? Mail coupon today!

Use this coupon for FREE booklet "How To Make Money in Mobile-Radio Maintenance" and information on Lampkin meters.

Name _____
Address _____
City _____ State _____ Zip _____

LAMPKIN LABORATORIES, INC.
MFM Div., Bradenton, Fla. 33505

**WORLD'S
FINEST
5-CORE
SOLDER**

**ERSIN
MULTICORE**

**NEW EASY
DISPENSER
PAK ONLY 59¢**

BUY IT AT RADIO-TV PARTS STORES

TEST EQUIPMENT PRODUCT REPORT

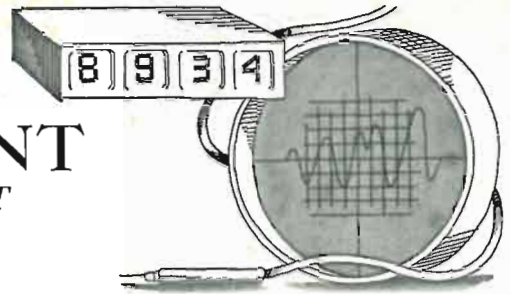

Triplett Model 5000 Digital Panel Meter

For copy of manufacturer's brochure, circle No. 3 on Reader Service Card.



will illuminate a figure "1." This display is then referred to as a 3½-digit type readout.

The accuracy of the reading is within 0.1 percent of full-scale, ± 1 count. By adding suitable series or shunt resistors, the basic panel meter can be converted into a voltmeter or ammeter. For example, the unit can be made to indicate full-scale readings of 1.000 V, 10.00 V, 100.0 V, 10.00 μ A, 1.000 mA, 1.000 A, or other values. The display is non-blinking and has a movable decimal point, automatic polarity, and over-range indicators.

FOR a good many years, *Triplett* has been a leading manufacturer of v.o.m.'s and other test equipment which use conventional, analog meters. But within the past few years, with the widespread use of digital circuits, the digital meter has grown in popularity. Such a meter indicates its reading by means of a display of discrete digits rather than by the movement of a pointer over a printed scale. The digital instrument gives precise readings that don't depend on the angle from which you view the pointer. Also, the same digital signals that produce the display of numbers are frequently available to produce a printed readout, or for other computing and control functions. Although simple to read, even by completely inexperienced personnel, the innards of a digital meter are far more complex and far more expensive than an analog meter movement.

Now joining the ranks of digital meter makers is *Triplett* with its new Model 5000. This is not a complete digital voltmeter instrument but is actually a digital panel meter that fits into a rectangular opening measuring about 4½ in by 2¾ in. The meter has a full-scale range of 100.0 millivolts which is displayed on a row of three Nixie readout tubes. To produce the left-hand digit, a neon lamp

The panel meter uses the dual-slope integration technique to convert an unknown analog voltage into a digital number. Basic operation consists of creating a ramp voltage with the unknown input voltage and then changing the direction of the ramp with a reference voltage. A precise measurement is then made of the time required to return to zero. Integrated circuits are used for the circuitry.

The meter has binary coded decimal (BCD) and decimal outputs to drive remote display or printer units. No added converters are required to operate these remote displays. The 1000-megohm input resistance reduces loading and improves reading accuracy. Reading rate is six readings per second.

Since the designers expect the meter to be installed in a panel where rear access might be difficult, they made the meter adjustable and serviceable from the front. The panel bezel is simply removed and the chassis is pulled out of the case, allowing the case to remain mounted on the panel.

The panel meter operates from its own self-contained and highly regulated 117-volt a.c. power supply. The instrument weighs less than 6½ lbs.

Price of the Model 5000 is \$300 for the regular unit. It is also available at somewhat lower cost with some of the special features omitted. ▲

B&K Model 162 Transistor Tester

For copy of manufacturer's brochure, circle No. 4 on Reader Service Card.

TRANSISTOR testers seem to be coming out thick and fast from the test-equipment manufacturers. All the

new testers have been designed with the FET in mind, so that these important semiconductors can be adequately



tested along with the conventional bipolar transistors.

The most recent such tester that we have seen is the new B&K Model 162. This instrument performs both in-circuit and out-of-circuit tests on transistors. It also tests diodes, unijunction transistors (UJT's), SCR's, and triacs.

A special balancing circuit is used to permit balancing out circuit impedances as low as 6 ohms for the in-circuit *beta* test. The tester has a current capability of up to 1 ampere in order to fully test power transistors and power FET's. *Beta* readings are from 1 to 5000 and five selective current ranges are provided. The manufacturer makes a point of the use of a front-panel socket for FET transistors to minimize the possi-

bility of damage due to static charges.

Three leakage tests are provided with the new instrument. These are tests for I_{CBO} (collector-base leakage current with the emitter circuit open), for I_{CEO} (collector-emitter leakage current with the base circuit open), and for I_{CES} (collector-emitter leakage current with the base shorted to the emitter). By providing all three leakage-current tests, we can detect avalanche-mode breakdown.

The instruction manual provided with the transistor tester is somewhat unusual. It is referred to as a "programmed instruction guide." The manual is compact (about 4 by 6½ inches), spiral-bound, plastic-covered, and contains 45 pages. It can be clipped to the back of the tester and its pages are on an easel-like support on the top of the unit. This makes it convenient to refer to any page in the manual while using the instrument. The booklet has been prepared to cover a single operating test per page, in order to simplify the setting up of the tester for the various transistor checks.

The Model 162 operates from two D-cells, which are soldered into place, hence the tester is completely portable. Test leads are stored in a compartment at the rear of the unit. The Model 162 measures 9 in by 7¼ in by 4 in deep and it weighs 6 lbs. Price is \$99.95. ▲

Sencore CG18 Color-Bar Generator

For copy of manufacturer's brochure, circle No. 5 on Reader Service Card.



SENCORE now has a line of three solid-state color-bar generators for the TV technician. You pay your money and you take your choice. The simplest and least expensive, at \$84.40, is the Model CG19, called the "Little Caddy Bar" because it is small enough to fit in the tube caddy. The most versatile and most expensive, at \$169.95, is the Model CG153, called the "Color King." In the middle is the CG18, the "Color Cadet" at \$129.95, which is the subject of our column this month.

The Model CG18 provides the usual color bars, horizontal lines, vertical lines, cross-hatch, and white-dot patterns required for setting up and converging a color-TV receiver. The size of the dots is adjustable from the front panel. Output is provided on any one of five TV channels, from channel 2 through 6.

The manufacturer has also increased the range of the timer adjustments. This range is double that of earlier Sencore color-bar generators. These adjustments are located on the front panel for convenience, but, since they are seldom used, they are in the form of screw-driver-operated controls.

Several useful and unusual features are worthy of special note. The case of the instrument, with its carrying handle and compartment for leads, has a mirror in the cover. This helps the technician keep his eyes on the color-tube screen while he is making back-chassis adjustments on the color set. There is also a meter at the bottom of the front panel that is used to check on the conditions of the eight C-cells that power the generator. Finally, there is an automatic shut-off that cuts off power when the lid is replaced. This is an excellent idea for the technician who forgets to turn the generator off, or in case someone else accidentally turns the unit on. Pilot lights are usually not used in battery-operated generators since the pilot light would consume more power than all the transistors (in this generator only 14 to 18 mA at 12 V). Thus, the automatic shut-off performs a useful function.

The Model CG18 measures 9½ in by 7¾ in by 3¾ in deep and it weighs 7 lbs. ▲

MR. SCA OPERATOR

NEED A RELIABLE SOURCE FOR HIGH QUALITY, LOW COST SCA RECEIVERS, OR SCA DEMODULATOR UNITS?

A new and proven sub-carrier demodulation scheme using old established principles is now practical due to recent component developments and mass production. The resultant reduction in cost is passed on to you.



MODEL SCA-6137 SINGLE FREQUENCY FM RECEIVER. Size: 12" x 5½" x 4½". Price: \$69.95 (Quantity 1-9)

SCA-6137 FM Receiver Features:

- Range: 88 to 108 MHz • Frequency Field Adjustable • All Solid State Devices • RF Stage
- 3 IF Stages • Automatic Frequency Control
- Two 67 KHz Amplifier Stages • 67 KHz Ratio Detector • Adjustable Muting • Main/Sub-Carrier Switch • One Watt Audio Output • 4" Monitor Speaker • Provision for External Speaker • 117 Volt AC Operated.

Also available: SCA-3 sub-carrier demodulator PC Card with muting control. Size: 2½" x 3" x ¼". Operates on 6 to 12 Volts DC at 6 ma. Available from stock. Price: \$39.95 (Quantity 1-9)

Quantity discounts and detailed specifications are available to SCA operators.

Send orders and inquiries to:

JanZac Company; P.O. Box 177;
Stamford, Conn. 06904

KenZac Company; P.O. Box 66251;
Houston, Texas 77006

CIRCLE NO. 125 ON READER SERVICE CARD

QUALIFY FOR YOUR FCC RADIOTELEPHONE LICENSE!

ICS has successfully trained thousands. Study at home, at your own speed, with the detailed personal attention of your highly qualified instructor. No time lost commuting to classes, or waiting for a class to catch up.

Course material includes detailed information on various FCC examinations and typical FCC examination questions, with answers explained in detail. Covers preparation for First, Second and Third Class tickets. Study one . . . or all three.

Your tuition refunded—or additional instruction provided—if you fail to pass your FCC exam after completing ICS instruction.

Don't wait—for full information send the coupon today.

ICS, Scranton, Pa. 18515

ICS International Correspondence Schools
Division of Intext D7747M

Mail to ICS, Scranton, Pa. 18515

Rush me free details on your warranted Radiotelephone License qualifying program.

Name _____ Age _____
(please print)

Address _____

City _____ State _____ Zip _____

Occupation _____

I am a veteran; tell me how I qualify under the new GI Bill.

CIRCLE NO. 129 ON READER SERVICE CARD

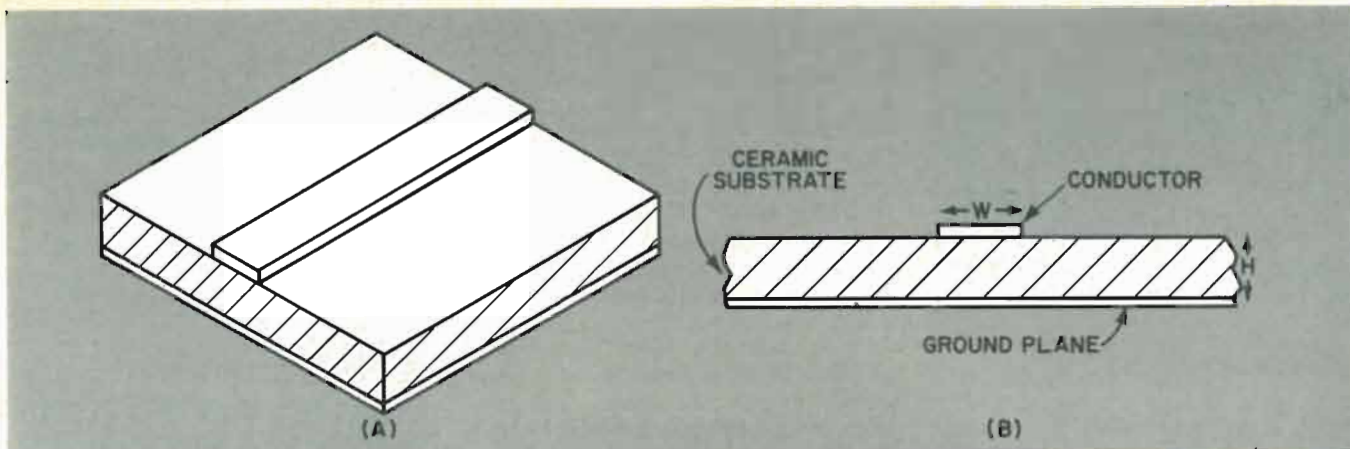

Fig. 1. Thin films of a flat, rectangular conductor strip deposited on side of a ceramic substrate with a conductive ground plane on the other side make up the microstripline circuit.

Microstripline Parameters

By LEON SALES/ Lockheed Electronics Co.

Having advantages of small size and light weight compared to microwave "plumbing," the microstripline technique is being widely used in airborne microwave and radar systems in conjunction with hybrid microelectronics.

WITH hybrid integrated circuits expanding into microwaves, microstripline circuitry is rapidly assuming an important role, particularly in airborne phased-array radar systems.

In this article microstripline will be defined, its advantages and disadvantages assessed, and design techniques examined. These techniques are also applicable to the design of waveguide and coaxial components in microcircuitry, such as filters, transformers, couplers, and cavities.

What is Microstripline?

Microstripline (Fig. 1) may be defined as a wire above a ground plane, being analogous to a two-wire line in which one of the wires is the ground-plane image of the actual wire. In practice, the wire that is employed, rather than being

round, is actually rectangular in its shape and almost flat.

The insulation is alumina ceramic (Al_2O_3). Other insulating materials are available to the designer: crosslinked polystyrene, irradiated polyolefin, glass-reinforced PTFE, and others. The choice of alumina ceramic is a trade-off, a particularly good one since its dielectric constant, which is on the order of 10.2, allows for a reduced size of stripline. Other considerations are low losses, good reaction to thermal cycling, and ease of machining.

The ground plane, which covers the entire underside of the ceramic insulation (or substrate) and the conductor are deposited on the substrate by photoelectric forming. The deposition process consists of a thin initial layer of vacuum-deposited nichrome or chromium, then electroplating a layer of copper, followed by a layer of gold which acts as a protective coating. Another technique omits the copper layer and allows the gold to be plated directly on the nichrome or chromium. Thus, the principal conductor is gold rather than copper. This process may be considered a thin-film technique. Thick-film techniques are also employed.

Producing Desired Impedance

Suppose a 50-ohm line is to be deposited on a ceramic substrate. The impedance (Z_0) of a microstripline is determined by the ratio of the width of the line (W) to the height of the dielectric (H) and the dielectric constant (E_R) of the insulating material.

Design equations employing the above parameters are complex and best handled by computer. However, a series of design curves derived by H. Caulton and H. Sobel's (of RCA) equations have been constructed. These curves are for a ceramic substrate, where $E_R = 10.2$, and where H is 0.025 inch. Other curves for other heights of substrates and other dielectric materials can be derived.

From the curve of Fig. 2 the readout obtained shows that a 50-ohm line should have a width (W) of 0.023 inch. How-

Fig. 2. Microstripline impedance vs line width for a dielectric constant of 10.2 and for a ceramic thickness or height of 0.025 inch. Line widths are given in thousandths of an inch.

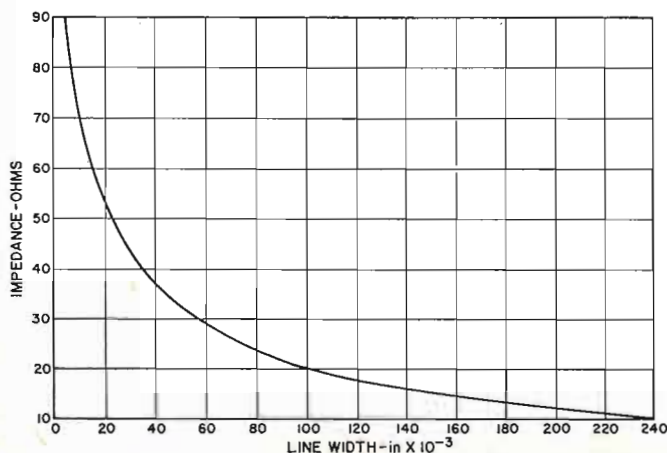

ever, a correction factor is needed. The above readout applies to lines having zero thickness so that the horizontal axis really shows W_{eff} rather than W . The need for a correction factor arises from the fact that a line of zero thickness exhibits a different Z_o than a line possessing a finite thickness. This correction factor (ΔW) must be applied to the parameter W_{eff} obtained from the curve. In this case, with a 0.001-in line to be deposited, ΔW comes out to a value of about 0.001 in. Thus, the width of the line should be: $0.023 - 0.001 = 0.022$ inch.

If a line possessing a critical length (quarter-wave line, half-wave line, etc.) is to be deposited, a dielectric problem is encountered. A microstripline effectively exists in a two-dielectric media environment; the ceramic substrate and the air above it. This situation results in a complex effect on wave velocity.

To compensate for this phenomenon, a correction factor multiplier (K) is applied to the length of the line. Again, employing equations by Caulton and Sobol and resulting computer data, a curve has been derived from which K may be found (Fig. 3). This correction factor is on the vertical axis and is shown as λ / λ_{TEM} , where λ is the wavelength in air and λ_{TEM} is the wavelength in the ceramic substrate that is being used as the example in this article. From the curve, K has a value of 1.23 for a 50-ohm line. Thus, at 3.0 GHz, $\lambda = 10.0$ cm, and $\lambda/4 = 2.5$ cm. This quarter wavelength is then multiplied by K : $2.5 \times 1.23 = 3.075$ cm, which is the actual length of line deposited.

To calculate the attenuation of the stripline, another curve has been derived and plotted as loss vs impedance, Fig. 4. The attenuation is expressed algebraically as $\alpha_c F^{-1/2} \times 10^6 = L$, where L is the value read on the vertical axis of the curve, F is the frequency in Hz, and α_c is loss in dB/in.

For a line having a Z_o of 50 ohms, $\alpha_c F^{-1/2} \times 10^6 = 2$. When this equation is simplified to:

$$\alpha_c = \frac{2}{(1/\sqrt{F}) \times 10^6}$$

and solved, $\alpha_c = 0.11$ dB/in at 3 GHz.

Advantages and Disadvantages

The advantages of microstripline are very attractive to the designer. Two obvious ones are its weight and size. A 4-to-1 hybrid divider-combiner, a circuit effectively combining four amplifiers in parallel (solid-state amplifiers are inserted at the arrows), is shown in Fig. 5. The wider lines have a Z_o of 50 ohms and the narrow lines a Z_o of 70 ohms. These narrow lines are quarter-wave lines at $F = 3.3$ GHz. Note the circuit's size; it weighs only about 0.2 ounce including the connectors.

Another advantage simplifies quality-assurance problems. This is the accuracy of microstripline circuit reproduction in any quantity. Since it is "constructed" by a photoelectric process, once the initial circuit is processed additional circuits are as easily produced as "prints from a negative."

Microstripline may also be employed as a lumped two-plate capacitor. The mathematics are similar to that of the commonly used paralleled-plate capacitor. The ground plane is considered as one plate and the other plate is deposited on the substrate.

There is a serious limitation to the size of a capacitor that can be deposited in microstripline. It must be of small value; otherwise it would occupy a large area. If large values are mandatory, discrete components are employed. These are in the nature of capacitor chips that are soldered directly to the stripline.

It should be pointed out that soldering to gold is a vexing problem. Gold is easily and rapidly dissolved in tin-lead solders. It has been found that the use of indium solder circumvents this problem.

Inductances in the microwave region may also be made in stripline circuitry. These take the form of a shorted line less

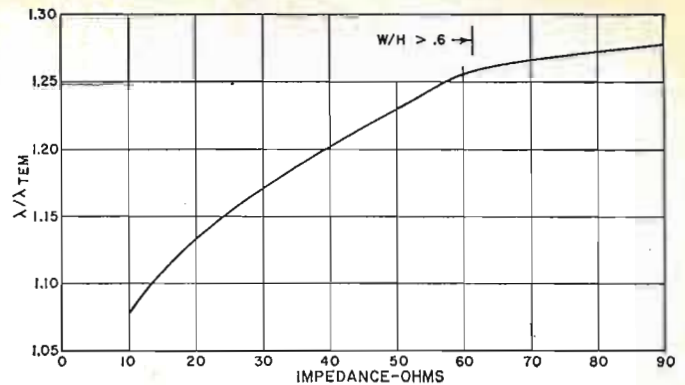

Fig. 3. Actual wavelength of a given section of microstripline is greater than wavelength in free air as shown here.

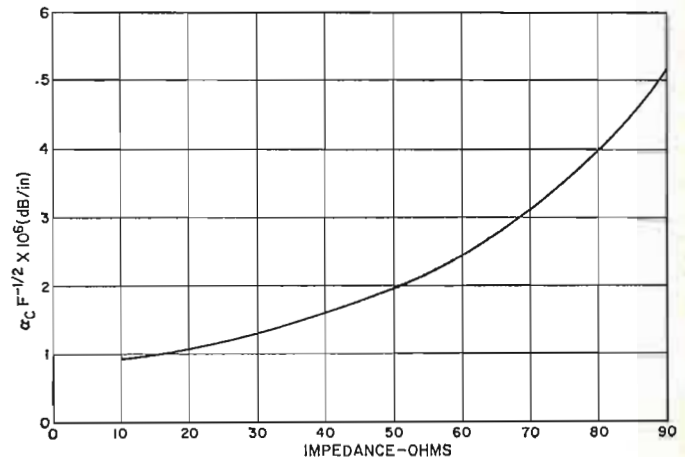

Fig. 4. Attenuation for microstripline at various impedances.

than a quarter-wavelength long at the operating frequency.

A difficulty arises in microstripline circuitry that is common to it and r.f. cable, particularly in the microwave region. This is that the bending of lines in sharp right-angle configurations is taboo. Two low-loss methods of bending microstripline employ a mitered 45° bend and a smooth round bend. Both have voltage standing-wave ratios of less than 1.1. The choice generally rests with the processing people as to which technique to employ, the criterion being the ease with which it fits into their particular process.

Microstripline has been on the electronic scene since the early 1950's. Its utilization, until just a few years ago, was limited. But its recent appearance in radar, coupled with the great strides made in microwave transistors, has generated a new boom in its use. ▲

Fig. 5. A 4-to-1 hybrid divider-combiner, which effectively combines four amplifiers (inserted at the arrows) in parallel. These amplifiers may simply be microwave transistors.

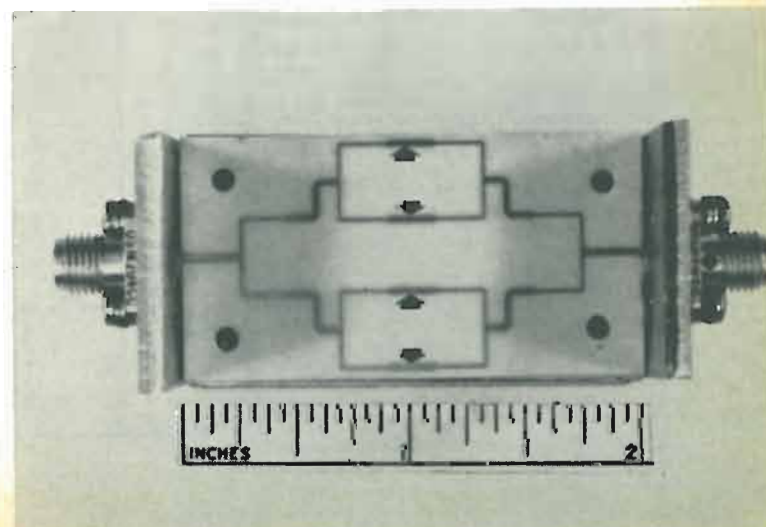

CLEAN YOUR TUNER THE PROFESSIONAL WAY! WITH TUN-O-FOAM



The pros know how to clean TV tuners so they really work. That's why more than 5 million tuners a year are cleaned, lubricated and restored by TUN-O-FOAM.

TUN-O-FOAM foams into the tightest places, melting away gunk and dirt. Then, it keeps on cleaning and lubricating contacts every time the channel is changed.

It's the only tuner cleaner that carries a six month guarantee. Try TUN-O-FOAM TODAY. It's easy to use and your set will play like new again.



**1260 RALPH AVE.
BROOKLYN, N.Y. 11236**

FOR EXPORT: ROBURN AGENCIES INC., NEW YORK, N.Y.
IN CANADA: PERFECT MANUFACTURING LTD. MONTREAL 8, CANADA

CIRCLE NO. 144 ON READER SERVICE CARD

Olson ELECTRONICS FREE Catalog

Fill in coupon for a FREE One Year Subscription to OLSON ELECTRONICS Fantastic Value Packed Catalog — Unheard of LOW, LOW PRICES on Brand Name Speakers, Changers, Tubes, Tools, Stereo Amps, Tuners, CB, HI-FI's, and thousands of other Electronic Values. Credit plan available.

NAME _____
ADDRESS _____
CITY _____ STATE _____
GIVE ZIP CODE _____

If you have a friend interested in electronics send his name and address for a FREE subscription also.

OLSON ELECTRONICS

545 S. Forge Street, Akron, Ohio 44308

CIRCLE NO. 119 ON READER SERVICE CARD

IC 12- to 6-V CONVERTER

By E. A. SACK / General Manager

Molecular Electronics Div., Westinghouse Electric Corp.*

Inexpensive IC voltage converter that permits operation of all transistorized, portable, 6-volt battery-operated equipment from the 12-volt battery source of any vehicle.

PORTABLE transistor radios and tape recorders are frequently designed for 6-volt operation, which is normally supplied by internal batteries. When battery-operated equipment is used continuously, the cost of battery replacement becomes prohibitive. However, when operating 6-volt portable equipment in a car or boat, normal battery attrition can be avoided by using the available 12-volt battery in the vehicle. Therefore, a practical method must be found to provide a stable 6-volt output from a 12-volt supply.

To use a simple voltage-dropping resistor to supply the 6 volts from a 12-volt source is both impractical and unsafe, inasmuch as the current drain of transistorized units varies widely with function and control settings. Practically, a regulated voltage converter that provides a steady 6-volt output, independent of equipment drain or fluctuations in the 12-volt source, is required.

A new integrated circuit (IC) manufactured by Westinghouse, offers an ideal, inexpensive solution to this problem. With this IC, plus a few additional components, a regulated voltage converter can be constructed that provides ample current for all types of portable, transistorized equipment.

Fig. 1 is the circuit diagram of the WC109T integrated circuit used in the voltage converter. When 9 to 24 volts are applied to the input, pin 9, transis-

tors Q5 and Q6 regulate the output voltage at pin 7 to the precise level called for by the voltage "feedback" to terminal 11. Regulation is accomplished by means of the IC's internal network which not only holds the output constant, independent of the output circuit, but also adjusts for any variation in the input voltage level. This IC is fully temperature-compensated. In addition, transistor Q7 can be used to limit the output current to a safe level in case of an overload or short circuit. A silicon controlled rectifier, SCR1, although not used in the 12- to 6-volt converter, is also built into this versatile IC for use in other applications.

Fig. 2 shows the complete voltage-converter including the IC with its required external circuit. Resistor voltage divider, R2-R1, sets the output to 6 volts by feeding back a portion of the output voltage to pin 11 of the IC. The 300-pF capacitor, C1, stabilizes the IC at high frequencies. Resistor R_{CL} sets the current level at which the IC "shuts itself off" in case of overload or short circuit.

The author has built several models of the 12- to 6-volt converter. One model, which is capable of supplying up to 200 mA, was constructed in a 2 $\frac{3}{4}$ " \times 2 $\frac{1}{8}$ " \times 1 $\frac{5}{8}$ " "Mimibox." The IC "can" in this model, pointed out by the pencil in

*Was formerly with Westinghouse but is presently Vice-President and General Manager of the Integrated Circuits Div. of General Instrument Corp.

Fig. 1. Schematic diagram of the Westinghouse integrated circuit used in constructing the inexpensive 12- to 6-volt regulated-voltage converter.

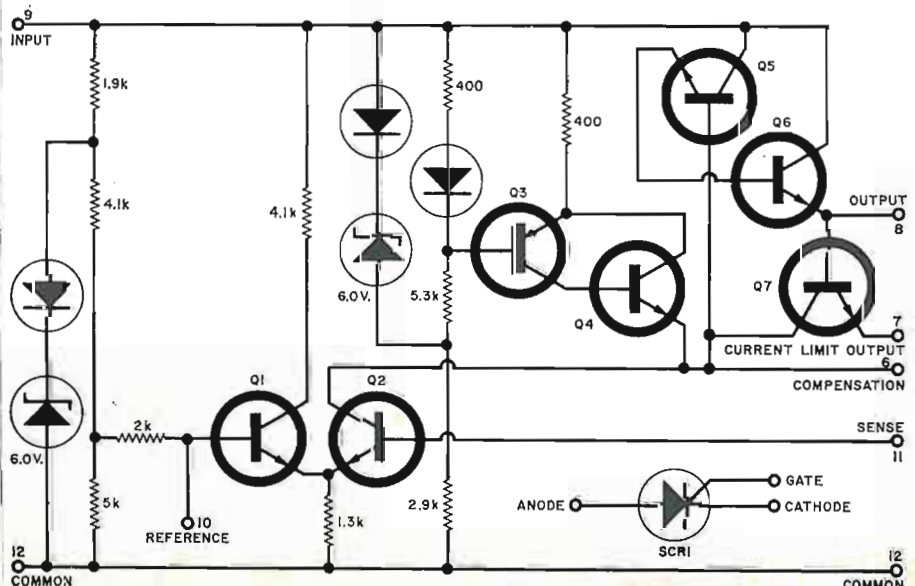

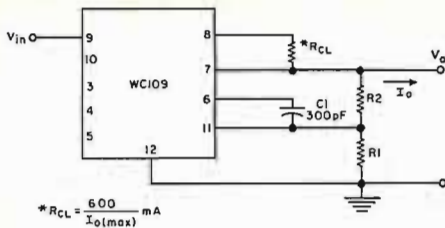

Fig. 2. Diagram of complete voltage converter showing IC and external circuits.

Fig. 3, is mounted directly against the chassis so that the aluminum case serves as a heat sink. An R_{CL} of 3 ohms is required. Parts placement is not critical except for the IC itself which should make good contact with the chassis for maximum heat transfer.

Another model of the 12- to 6-volt converter has been built into the body of a cigarette-lighter plug such as the one shown in Fig. 3. Plugs of this type are available at auto supply stores and have sufficient space in the screw-on cap to house all of the components used in the converter. An R_{CL} of 6 ohms was selected for this model to limit output current to 100 mA, which is the maximum allowable without overheating the IC housed in the confined space of the plug's shank.

It is interesting to note that the total price of the IC, which contains over 20 components, is little more than the cost of a single transistor or zener diode. The electronic technician benefits from using these modern components as they become increasingly available at surprisingly low prices.

(Editor's Note: The WC109T IC may be obtained from local electronic parts distributors or from either of the following sources: Customer Service, Integrated Circuit Division, General Instrument Corp., 600 W. John St., Hicksville, N.Y. 11802 or Canadian Westinghouse, Ltd., P.O. Box 510, Hamilton, Ontario, Canada.

Fig. 3. Model of the converter built by the author. Converter is capable of supplying output currents up to 200 mA. IC is indicated by pencil. Cigarette-lighter plug housing is shown in foreground.

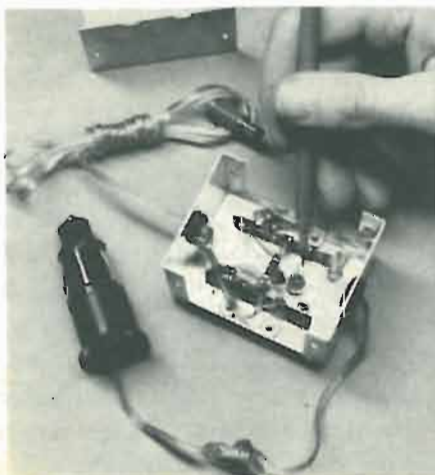

Need high temperatures in tiny places?

The amazing Little Torch is so tiny it can throw a flame of 6300°F. through the eye of a needle. It solders, brazes, welds and heats with exacting precision in the smallest places; uses oxygen and acetylene,

hydrogen, propane, natural gas or Mapp. It's available with five tips ranging in size from one large enough to weld 16 ga. steel to one small enough to weld .002" copper wire. For free brochure write to:

The "Little Torch"



Instrument
DIVISION



Dept. 133-0, 2633 S.E. 4th St., Minneapolis, Minnesota 55414
CIRCLE NO. 137 ON READER SERVICE CARD

Build this pipelike Schober Recital Organ for only \$1850!*

You couldn't touch an organ like this in a store for less than \$4,000—and there never has been an electronic instrument with this vast variety of genuine pipe-organ voices that you can add to and change any time you like! All four families of formal pipe tones are present in variety to delight players of classic and religious music. Yet you can change the entire organ for popular and theatrical sounds, or plug in special voices for baroque, romantic, or modern repertoires. If you've dreamed of the sound of a large pipe organ in your own home, if you're looking for an organ for your church, you'll be more thrilled and happy with a Schober Recital Organ than you could possibly imagine—kit or no kit.

You can learn to play it—and a full-size, full-facility instrument is easier to learn on than any cut-down "home" model. And you can build it, from Schober Kits, world famous for ease of assembly without the slightest knowledge of electronics or music, for design and parts quality from the ground up, and—above all—for the highest praise from musicians everywhere.

Send right now for the full-color Schober catalog, containing specifications of all five Schober Organ models, beginning at \$499.50. No charge, no obligation. If you like music, you owe yourself a Schober Organ!



* Includes finished walnut console. (Only \$1446 if you build your own console.) Amplifier, speaker system, optional accessories extra.

The Schober Organ Corp., Dept. RN-73
43 West 61st Street, New York, N.Y. 10023

- Please send me Schober Organ Catalog and free 7-inch "sample" record.
- Enclosed please find \$1.00 for 12-inch L.P. record of Schober Organ music.

NAME _____
ADDRESS _____
CITY _____ STATE _____ ZIP _____

CIRCLE NO. 110 ON READER SERVICE CARD

**“He’s a good worker.
I’d promote him
right now if he had
more education
in electronics.”**



Could they be talking about you?

You'll miss a lot of opportunities if you try to get along in the electronics industry without an advanced education. Many doors will be closed to you, and no amount of hard work will open them.

But you can build a rewarding career if you supplement your experience with specialized knowledge of one of the key areas of electronics. As a specialist, you will enjoy security, excellent pay, and the kind of future you want for yourself and your family.

Going back to school isn't easy for a man with a

full-time job and family obligations. But CREI Home Study Programs make it possible for you to get the additional education you need without attending classes. You study at home, at your own pace, on your own schedule. You study with the assurance that what you learn can be applied to the job immediately.

CREI Programs cover all important areas of electronics including communications, radar and sonar, even missile and spacecraft guidance. You're sure to find a program that fits your career objectives.



**IN-DEPTH
 COVERAGE OF
 SOLID STATE
 ELECTRONICS**
 ...including
 integrated circuits!

You're eligible for a CREI Program if you work in electronics and have a high school education. Our FREE book gives complete information. Mail postpaid card for your copy. If card is detached, use coupon at right or write: CREI, Dept. 1101A, 3224 16th St., N.W., Washington, D.C. 20010.

**CREI, Home Study Division
 McGraw-Hill Book Company
 Dept. 1101A, 3224 Sixteenth Street, N.W.
 Washington, D.C. 20010**

Please mail me FREE book describing CREI Programs. I am employed in electronics and have a high school education.

NAME _____ AGE _____

ADDRESS _____

CITY _____ STATE _____ ZIP CODE _____

EMPLOYED BY _____

TYPE OF PRESENT WORK _____ G.I. BILL

- I am interested in
- Electronic Engineering Technology Computers
 - Space Electronics Nuclear Engineering Technology
 - Industrial Automation NEW! Electronics Systems Engineering



APPROVED FOR TRAINING UNDER NEW G.I. BILL

SOLID-STATE V.O.M.

By JIM ASHE and JOHN EISENBERG

Design of an instrument with minimum drift and good linearity. Field-effect input transistors and a true difference amplifier make the instrument unique.

TWO problems face the designer of a really good instrument. One is the matter of active devices whose properties are almost always nonlinear and vary from one device to the next; the other is unavoidable changes in device characteristics with temperature, supply voltage, and aging.

Here is a relatively simple high-resistance, solid-state meter circuit whose linearity is limited only by the meter movement characteristics. It measures d.c. voltages from 150 millivolts full-scale to 1500 volts full-scale and resistances from 10 ohms to 1 megohm. It requires few specialized parts and it's simple to build. Once assembled and calibrated, its stability and drift resistance are excellent.

The Drift Problem

An elementary, but often used, method of reducing unwanted drift is to provide a drift in the opposite direction, usually from a non-signal-carrying active device in a circuit similar to that of the signal device. This works, after a fashion, but it is not really suited to accurate, reliable instrument design.

A better technique is to develop a circuit that is blind to its own drifts; typically, a difference amplifier biased from a constant-current generator. This circuit configuration has additional advantages. Nonlinearities tend to balance out and the output is an almost perfectly linear function of input.

Two other methods for reducing drift and improving linearity are to use large, regulated power supplies and to choose devices having a very high input resistance. All three of these techniques are used in this ohmmeter: true difference amplifier, large supply voltages, and field-effect input transistors.

The simplified schematic of Fig. 1 shows how the meter circuit works. A constant-current generator regulates the current to Q1 and Q2 at 3 mA, by maintaining a fixed voltage across Q3's emitter resistor and transferring the resulting current to its collector terminal and the difference amplifier. If either Q1 or Q2 needs more current, the other has to get by with less. Now suppose a small d.c. signal is applied to Q1, as in making a voltage measurement. As the transistor's current changes, the other transistor's current must change in the opposite direction. Thus, input-output nonlinearities will balance out.

During normal operation both transistors are warmed a few degrees by current flow in the circuit. The base-emitter voltage of both devices rises slightly, increasing base and collector currents. Collector voltages are slightly reduced; but since this change occurs equally at both collector terminals, the meter does not indicate a change in its zero points.

The actual circuit (Fig. 3) operates in a similar manner. But, each transistor in Fig. 1 is replaced by a combined FET and bipolar transistor, the constant-current generator has moved to the collector side of the transistors and a current source has been added in its place. Calibrating pots

R23 ("Volts") and R24 ("Ohms") and a reversing switch have also been added.

Voltage ranges are determined by the 150-mV full-scale sensitivity of the calibrated circuit and by the voltage divider resistors R1 through R9. This arrangement is appropriate for d.c. measurements only.

The ohmmeter circuit is a simple variation of the voltage-divider idea. An ordinary "D"-size cell supplies 1.5 volts d.c. through a series resistance consisting of some or all resistors R10 through R16. Fig. 2 shows how the ohmmeter works. In effect, the unknown resistance is compared with the ohmmeter resistances. If R_x is shorted, the meter reads zero volts or zero ohms. If R_x is infinitely large, the entire battery voltage appears across the ohmmeter terminals, giving full-scale reading. And when R_x equals the value of the series resistance (10 ohms on the lowest resistance range), the meter reads one-half full-scale.

An ohmmeter calibration curve can be calculated very easily. The equation for R_x in Fig. 2 is the familiar voltage-divider equation turned inside out to show resistance rather than output voltage.

Power Supply

Bipolar supply voltages (Fig. 3) are provided from a sin-

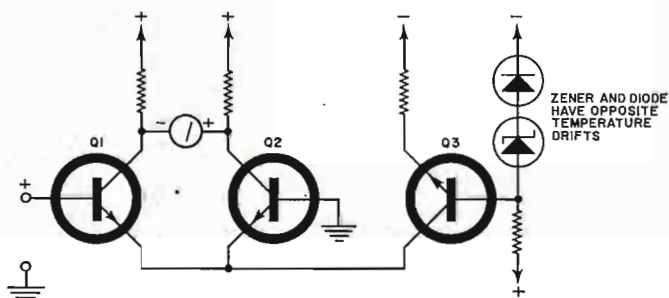
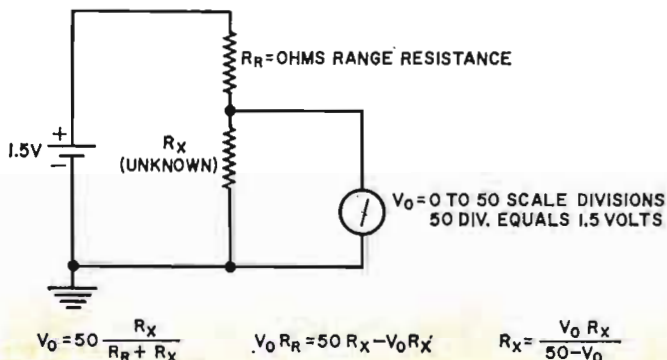

Fig. 1. Simplified circuit of difference amplifier and constant current source. The amplifier is impervious to its own drifts.

Fig. 2. This schematic shows the ohmmeter's divider feature. The equations included are used to calculate calibration points.



gle transformer through two emitter-follower regulators. Most of the instrument's power is dissipated in the form of zener current. The transformer and rectifier can be replaced by a pair of batteries, but the emitter-follower regulator should be retained to avoid calibration errors from battery aging.

Supply voltages (± 15 volts) are not critical, but deserve respect because they indirectly determine the circuit's operating points. Two half-wave rectifiers, D3 and D4, rectify the 24-volt transformer output, feeding two large filter capacitors. Current drain is only a few mA and ripple is small. The d.c. output voltage is regulated down to 15 volts by two emitter-follower regulators referenced to a pair of inexpensive G-E zener diodes. Capacitors across the diodes control any zener noise. C6 and C7 are output filters.

Construction and Calibration

It is relatively easy to build the linear meter. A 3" x 5" x 10" aluminum box can be used. The right-hand half of the box could be used for power-supply components and the relatively large meter. There is more than enough room in the left half for the controls, circuit boards, and the 1.5-volt ohmmeter battery.

Just about all of the solid-state meter's components can be mounted on pre-punched terminal boards. This serves to make a neat assembly and reduce wiring requirements.

While construction is not critical, there are a few areas where the builder should take special care. Transistors Q2 and Q4 should be heat-sinked for stability. Diodes D1 and D2 should not be replaced with so-called equivalent types. These devices are especially chosen for the direction of their temperature drifts. The 1N914 has a slightly negative temperature drift, the 1N750A a positive drift, thus the two cancel. However, the relatively expensive 2N2497 FET's (priced at \$6.45 in single quantities) can be replaced by Type 2N2386 (about \$3.75). They differ only in transconductance. Resistors R21 and R28 (3300 ohms) and R22 and R29 (8200 ohms) should be matched pairs. Incidentally, the 50-microampere meter should have large scale-divisions if the circuit's linearity and stability are to be put to best use.

Meter calibration is easy. Use an accurate low-voltage source (about 1.35 volts) as a check. Adjust the voltage reading to the correct value by varying the resistance of the R23 voltage calibrator. If the meter movement is linear and the circuit's resistors stable, this calibration should be good at all voltage ranges.

The resistance function is similarly checked. Short the test leads to verify meter zero. Then adjust the "Ohms Calibrate" pot to read full-scale with the ohmmeter's terminals open. This reading should be in agreement with the calibration curve. ▲

Fig. 3. The complete schematic diagram and parts list for the solid-state volt-ohmmeter and its regulated power supply.

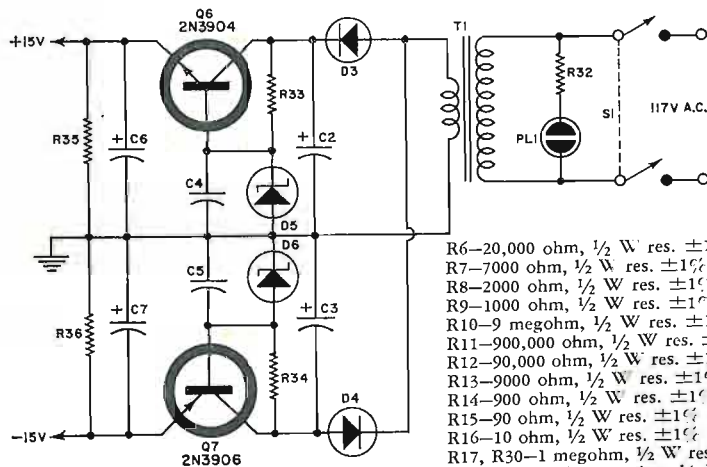

- R1—7 megohm, 1/2 W res. $\pm 1\%$
- R2—2 megohm, 1/2 W res. $\pm 1\%$
- R3—700,000 ohm, 1/2 W res. $\pm 1\%$
- R4—200,000 ohm, 1/2 W res. $\pm 1\%$
- R5—70,000 ohm, 1/2 W res. $\pm 1\%$

- R6—20,000 ohm, 1/2 W res. $\pm 1\%$
- R7—7000 ohm, 1/2 W res. $\pm 1\%$
- R8—2000 ohm, 1/2 W res. $\pm 1\%$
- R9—1000 ohm, 1/2 W res. $\pm 1\%$
- R10—9 megohm, 1/2 W res. $\pm 1\%$
- R11—900,000 ohm, 1/2 W res. $\pm 1\%$
- R12—90,000 ohm, 1/2 W res. $\pm 1\%$
- R13—9000 ohm, 1/2 W res. $\pm 1\%$
- R14—900 ohm, 1/2 W res. $\pm 1\%$
- R15—90 ohm, 1/2 W res. $\pm 1\%$
- R16—10 ohm, 1/2 W res. $\pm 1\%$
- R17, R30—1 megohm, 1/2 W res.
- R18, R35, R36—3300 ohm, 1/2 W res.
- R19—5000 ohm carbon pot
- R20—200 ohm carbon pot
- R21, R28—3300 ohm, 1/2 W res. (matched $\pm 5\%$)
- R22, R29—8200 ohm, 1/2 W res. (matched $\pm 5\%$)
- R23—20,000 ohm carbon pot

- R24—500,000 ohm carbon pot
- R25, R27—3900 ohm, 1/2 W res.
- R26—1600 ohm, 1/2 W res. $\pm 5\%$
- R31—4700 ohm, 1/2 W res.
- R32—100,000 ohm, 1/2 W res.
- R33, R34—1000 ohm, 1 W res.
- C1, C4, C5—0.01 μ F, 100 V disc capacitor
- C2, C3—1000 μ F, 50 V elec. capacitor
- C6, C7—22 μ F, 25 V elec. capacitor
- PL1—Ne-2A pilot light
- T1—Trans. 24 V at 2 A (UTC FT-18 or equiv.)
- S1—D.p.d.t. switch (power)
- S2—S.p. 9-pos. switch ("Volts")
- S3—S.p. 7-pos. switch ("Ohms")
- S4—4-pole, 3-pos. switch ("Ohms, — Volts, + Volts")
- B1—1.5 V "D" cell
- D1—1N914 zener diode
- D2—1N750A zener diode. (No substitutions for either zener).
- D3, D4—1N1692 diode, 100 p.i.v., 500 mA
- D5, D6—Z4XL16A zener diode, 16 V, 1 W
- Q1, Q5—2N2497
- Q2, Q4—2N3391A
- Q3, Q7—2N3906
- Q6—2N3904
- M1—50- μ A meter

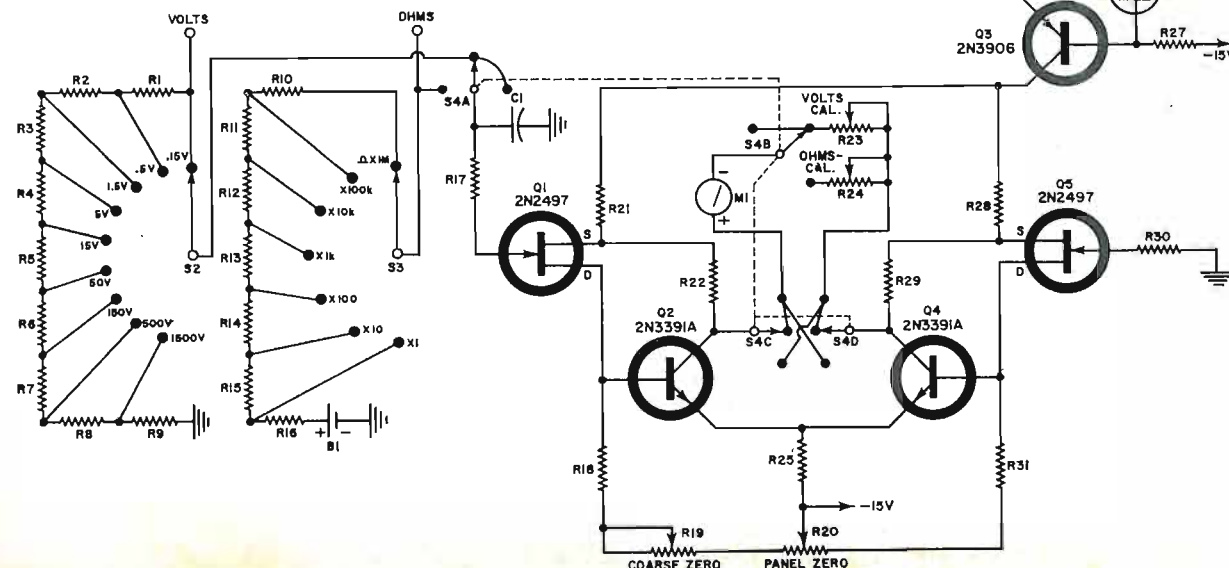

More New Kits From

Introducing The Advanced New Heathkit 60-Watt AM/FM/FM Stereo Receiver

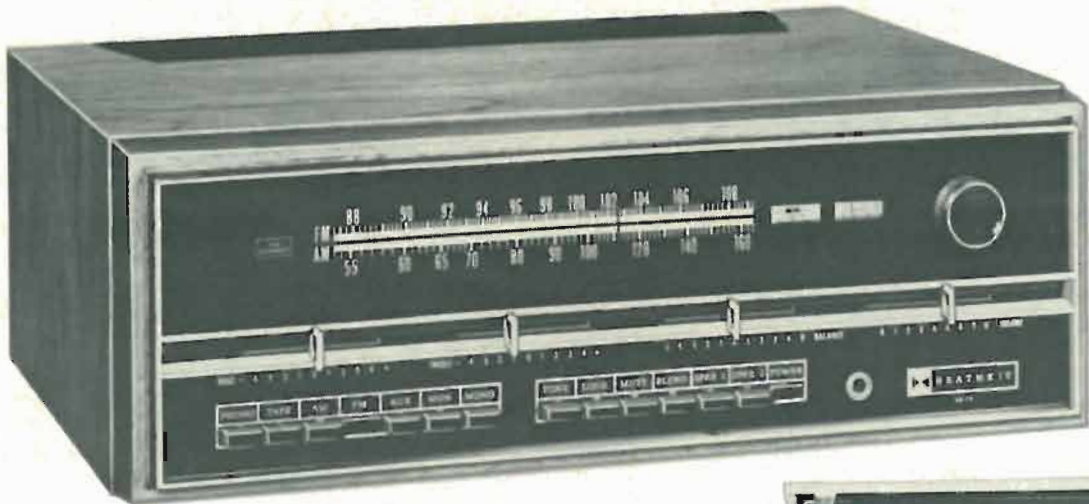

Heathkit AR-19

\$225.00*

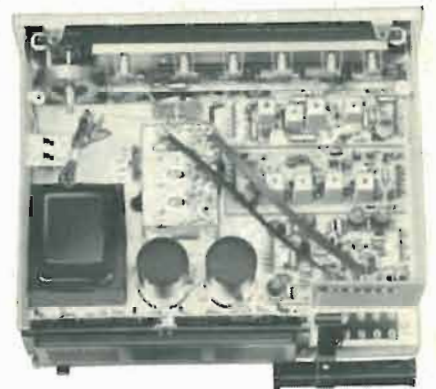

Third In The New Generation Of Superb Solid-State Receivers From Heath . . . And Low In Cost

- Advanced solid-state circuitry with 108 transistors, 45 diodes and 5 integrated circuits • 60 watts music power output at 8 ohms • Less than 0.25% Harmonic & IM Distortion at any power level • Frequency response from 6 to 35,000 Hz • Direct-coupled, transformerless outputs for lowest distortion and phase shift • Dissipation-limiting circuitry protects outputs from damage even with a short circuit • Assembled, aligned FET FM tuner has 2.0 uV sensitivity to give you more listenable stations • Ball-bearing inertia flywheel tuning for smooth, accurate station selection • Preamsembled, factory aligned FM IF circuit board speeds assembly and eliminates IF alignment, gives 35 dB selectivity • Multiplex IC circuit provides inherent SCA rejection • Pushbutton Mute control attenuates between-station FM noise • Blend control reduces on-station FM noise with a push of a button • Tone-flat pushbutton disables bass & treble controls for perfectly "flat" response • New linear motion controls for volume, balance, bass & treble • Individually adjustable level controls for each input including tape monitor eliminate annoying volume changes when switching sources • Switches for two separate stereo speaker systems for stereo sound in two different locations • Center channel speaker capability • Two front panel tuning meters give exact station selection • Stereo indicator light • Front panel stereo headphone jack • 300 & 75 ohm FM antenna inputs • High fidelity AM reception • Built-in AM rod antenna swivels for best reception • Massive power supply includes section of electronically regulated power • New Heath modular plug-in circuit board design speeds assembly, aids servicing • Built-in Testing facilities aids construction, simplifies servicing • Circuit board & wiring harness construction for easy, enjoyable 25 hour assembly

Ahead of its time . . . those who want to hear stereo high-fidelity as it will sound in the 70's can begin right now, at a modest price, with the Heathkit AR-19. Its design is an extension of the advanced circuitry concepts first introduced in the AR-15. These receivers are truly of a new generation . . . they've expanded audio engineering horizons and set the pace for the 70's.

Field Effect Transistor And Integrated Circuit Design. The AR-19 uses advanced semi-conductor circuitry . . . including five integrated circuits, with a total of 108 transistors and 45 diodes. The pre-assembled FM tuning unit uses an RF field effect transistor to provide high sensitivity and low cross modulation with no overloading

on strong local stations. In the AM RF circuit also, field effect transistors give superior sensitivity and large signal handling capacity.

Ideal For Most Home Stereo Installations. The AR-19 is just right for the medium and high efficiency speaker systems that are so popular today. It can form the nucleus of a fine stereo system . . . and will probably be the most attractive part, thanks to its rich oiled pecan wood cabinet and to the "Black Magic" front panel. The scale and dial readings appear only when the power is on.

Features To Aid The Kit Builder. All 8 circuits of the AR-19 snap in and out in seconds. Think of the resulting convenience and ease of assembly! In addition, the AR-19 has built-in test circuitry . . . two test probes with the front panel meter for indications. With it, the user can check out circuit parts without the need for expensive external test equipment. Proper use of this feature is fully covered in the manual.

Don't Wait For Something Better To Come Along . . . it'll be a long wait. Up-grade your stereo system now, with this outstanding receiver value.

Kit AR-19, 29 lbs. \$225.00*
Assembled AE-19, cabinet, 10 lbs. \$19.95*

PARTIAL AR-19 SPECIFICATIONS — AMPLIFIER: Continuous power output per channel: 20 watts, 8 ohms. **IHF Power output per channel:** 30 watts, 8 ohms. **Frequency response:** (1 watt level) —1 dB, 6 Hz —35 kHz. **Power bandwidth for constant 0.25% THD:** Less than 5 Hz to greater than 30 kHz. **Harmonic distortion:** Less than 0.25% from 5 Hz to 20 kHz at 20 watts rms output. Less than 0.1% at 1000 Hz at 1 watt output. **IM Distortion:** Less than 0.25% with 20 watts output. Less than 0.1% at 1 watt output. **Hum and noise:** Phono input, —65 dB. **Phono input sensitivity:** 2.4 millivolts; overload, 155 millivolts. **FM: Sensitivity:** 2.0 uV, IHF. **Volume sensitivity:** Below measurable level. **Selectivity:** 35 dB. **Image rejection:** 90 dB. **IF Rejection:** 90 dB. **Capture ratio:** 2.5 dB. **Total harmonic distortion:** 1% or less. **IM Distortion:** 0.5% or less. **Spurious rejection:** —90 dB. **FM STEREO: Separation:** 35 dB of midfrequencies; 30 dB at 50 Hz; 25 dB at 10 kHz; 20 dB at 15 kHz. **Frequency response:** ±1 dB from 20-15,000 Hz. **Harmonic distortion:** 1.5% or less @ 1000 Hz with 100% modulation, 19 kHz & 38 kHz. **Suppression:** 50 dB. **SCA Suppression:** 50 dB. **AM SECTION: Sensitivity:** Using a radiating loop, 130 uV/VA @ 1000 kHz. **Selectivity:** 25 dB at 10 kHz. **Image rejection:** 60 dB @ 600 kHz, 60 dB @ 1400 kHz. **IF Rejection:** 60 dB @ 1000 kHz. **Harmonic distortion:** Less than 2%. **Hum & noise:** —40 dB.

New Heathkit 100-Watt AM/FM/FM-Stereo Receiver

World's finest medium power stereo receiver . . . designed in the tradition of the famous Heathkit AR-15. All Solid-State . . . 65 transistors, 42 diodes plus 4 integrated circuits containing another 56 transistors and 24 diodes. 100 watts music power output at 8 ohms — 7 to 60,000 Hz response. Less than 0.25% distortion at full output. Direct coupled outputs protected by dissipation-limiting circuitry. Massive power supply. Four individually heat sunk output transistors. Linear motion bass, treble, balances and volume controls. Push-button selected inputs. Outputs for 2 separate stereo speaker systems. Center speaker capability. Stereo headphone jack. Assembled, aligned FET FM tuner has 1.8 uV sensitivity. Two tuning meters. Computer designed 9-pole L-C filter plus 3 IC's in IF gives ideally shaped bandpass with greater than 70 dB selectivity and eliminates alignment. IC multiplex section. Three FET's in AM tuner. AM rod antenna swivels for best pickup. Kit Exclusive: Modular Plug-In Circuit Boards . . . easy to build & service. Kit Exclusive: Built-In Test Circuitry lets you assemble, test and service your AR-29 without external test equipment. The AR-29 will please even the most discriminating stereo listener.

Kit AR-29, (less cabinet), 33 lbs. \$285.00*
 AE-19, Assembled oiled pecan cabinet, 10 lbs. \$19.95*



Kit AR-29
\$285*

New Heathkit Deluxe 18-Watt Solid-State Stereo Phono

Looks and sounds like it should cost much more. Here's why: 16-transistor, 8-diode circuit delivers 9 watts music power per channel to each 4 1/2" high-compliance speaker. Speaker cabinets swing out or lift off . . . can be placed up to 10' apart for better stereo. Has Maestro's best automatic, 4-speed changer — 16, 33-1/3, 45 & 78 rpm. It plays 6 records, shuts off automatically. Ceramic stereo cartridge with diamond/sapphire stylus. Has volume, balance & tone controls. Changer, cabinet & speaker enclosures come factory built . . . you build just one circuit board . . . one evening project. Wood cabinet has yellow-gold & brown durable plastic coated covering. This is a portable stereo you can take pride in.

Kit GD-109, 38 lbs. \$74.95*



Kit GD-109
\$74.95*

New Heathkit 80-10 Meter 2 KW Linear Amplifier

Incomparable performance and value. The new SB-220 has 2000 watts PEP input on SSB & 1000 watts on CW and RTTY. Uses a pair of Eimac 3-500Z's. Pretuned broad band pi input coils. Requires only 100 watts PEP drive. Solid-state power supply operates from 120 or 240 VAC. Circuit breaker protected. Safety interlocked cover. Zener diode regulated operating bias. Double shielded for max. TVI protection. Quiet fan — fast, high volume air flow. Also includes ALC to prevent over-driving. Two meters: one monitors plate current; the other is switched for relative power, plate voltage and grid current. Styled to match Heath SB series. Assembles in about 15 hours.

Kit SB-220, 55 lbs. \$349.95*



Kit SB-220
\$349.95*

New Heathkit

Solid-State Portable
 Fish-Spotter



Kit MI-29
\$84.95*

Costs half as much as comparable performers. Probes to 200 ft. Spots individual fish and schools . . . can also be used as depth sounder. Manual explains typical dial readings. Transducer mounts anywhere on suction cup bracket. Adjustable Sensitivity Control. Exclusive Heath Noise-Reject Control stops motor ignition noise. Runs for 80 hrs. on two 6 VDC lantern batteries (not included). Stop guessing — fish electronically.

Kit MI-29, 9 lbs. \$84.95*



Kit MI-19
\$69.95*

New Heathkit Solid-State Depth Sounders

Let its flashing indicator light guide you through strange waters . . . day or night. Sounds to 200 ft. Has Noise Rejection and Sensitivity controls. Operates from your 12 VDC boat battery. Sun-shielded dial. All solid-state.

Kit MI-19-1, (with thru-hull transducer), 7 lbs. \$69.95*

Kit MI-19-2, (with high speed transom mount), 7 lbs. \$69.95*



NEW
FREE 1970 CATALOG!
 Now with more kits more color. Fully describes these along with over 200 kits for stereo hi-fi, color TV, electronic organs, guitar amplifiers, amateur radio, marine educational CB, home & hobby. Mail coupon or write Heath Company, Benton Harbor, Michigan 49022.

HEATH COMPANY, Dept. 15-1
 Benton Harbor, Michigan 49022

a Schlumberger company

Enclosed is \$ _____, plus shipping.

Please send model (s) _____

Please send FREE Heathkit Catalog.

Please send Credit Application.

Name _____

Address _____

City _____

State _____

Zip _____

*Mail order prices; F.O.B. factory. Prices & specifications subject to change without notice.

CL-373

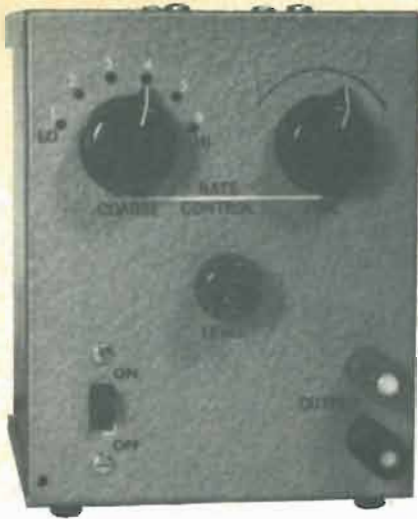

Over-all view of SCS pulse generator. Unit is housed in 5" x 4" x 3" cabinet.

SCS Positive-Pulse Generator

By FRANK H. TOOKER

Using an inexpensive silicon controlled switch, this circuit can produce pulses over a wide range of repetition rates.

ELECTRONIC counters, tachometers, and other devices using computer-like circuitry are becoming so numerous that instruments not usually found on the average lab bench now have actual need to be there. One such instrument is the pulse generator, an oscillator which puts out signals having a sharp, spike-like waveform. The majority of counters, tachometers, and so on, use such pulses in the course of their normal operation. Furthermore, the majority of such devices employ silicon *n-p-n* semiconductors, thus most of them require pulses with positive polarity.

The instrument shown in the photo and Fig. 1 produces positive-going pulses of spike waveform, with a repetition rate continuously variable from 2 to 25,000 pulses per second. The very slow repetition rates, available at the lowest setting of the range switch, are especially valuable in design work, experimenting, and troubleshooting. With them, ade-

quate time is available to check the sequence of events in a stage being tested, during the interval between pulses. A number of pulse generators do not have this range.

How It Works

Repetition rate is determined by the resistance-capacitance values in the anode circuit of the silicon controlled switch, Q1 in Fig. 1. Without these components, *i.e.*, with the anode open-circuited, the SCS operates as an *n-p-n* bipolar transistor, with its gain limited by degeneration, due to the unbypassed resistor in the cathode circuit.

If, under this circumstance, a large value resistor is connected in the anode circuit—between the anode and the positive side of the power supply—and the value of this resistance is gradually decreased, regeneration takes place and, as a result, the gain of the *n-p-n* increases. Quite soon in the course of this process, the setup becomes unstable. At this point, the SCS switches into its on-state.

If a capacitor is connected between anode and ground, current flowing through the anode resistor will be diverted to charge the capacitor and the SCS switches "off." As the capacitor charges, however, and the potential across it increases, a point is reached where the setup again becomes unstable. At this point, the SCS switches "on," discharges the capacitor through cathode resistor R6, and switches "off" again. The capacitor then recharges through the anode resistor, and the cycle repeats. The result is a train of spike-like pulses developed across the cathode resistor.

This, in simple terms, is how the SCS positive-pulse generator operates. Its performance is somewhat similar to that of a unijunction transistor although, for a number of applications, it is more flexible to work with.

The turn-off characteristic of the SCS is not nearly as rapid or as clean as its turn-on. A step or "back porch" develops on the waveform near the conclusion of turn-off. This may be seen in an oscilloscope trace of the output waveform when the instrument is being operated at its highest repetition rates. At all except the highest rates, the porch is removed by differentiation.

In the positive-pulse generator, coarse

Fig. 1. Complete schematic and parts list for SCS positive-pulse generator.

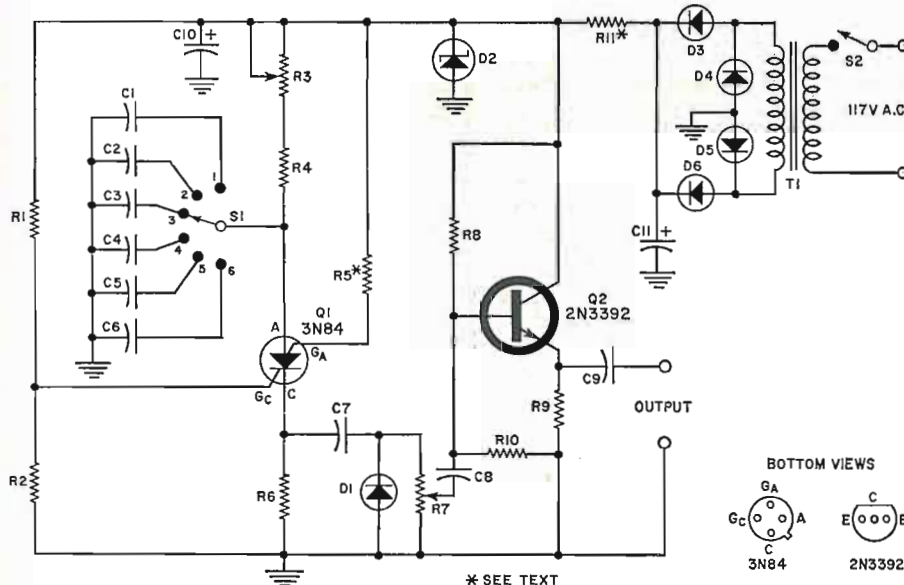

- R1—82,000 ohm, 1/2 W res.
- R2—15,000 ohm, 1/2 W res.
- R3—350,000 ohm linear-taper pot
- R4—56,000 ohm, 1/2 W res.
- R5—6800 ohm, 1/2 W res. (see text)
- R6—1000 ohm, 1/2 W res.
- R7—10,000 ohm linear-taper pot
- R8—220,000 ohm, 1/2 W res.
- R9—3900 ohm, 1/2 W res.
- R10—330,000 ohm, 1/2 W res.
- R11—120 ohm, 1/2 W res. (see text)
- C1—2.0 μ F, 100 V Mylar capacitor
- C2—0.47 μ F, 100 V Mylar capacitor
- C3—0.1 μ F, 100 V Mylar capacitor
- C4—0.022 μ F, 100 V Mylar capacitor

- C5—0.0047 μ F, 100 V Mylar capacitor
- C6—0.001 μ F, 100 V Mylar capacitor
- C7—0.01 μ F, 100 V Mylar capacitor
- C8—0.047 μ F, 100 V Mylar capacitor
- C9—0.22 μ F, 100 V Mylar capacitor
- C10—200 μ F, 10 V elec. capacitor
- C11—150 μ F, 15 V elec. capacitor
- S1—S.p. 6-pos. shorting-type miniature rotary sw.
- S2—S.p.s.t. slide switch
- T1—Miniature power trans. 12 V at 10 mA
- D1—1N191 computer diode
- D2—10 V, 400 mW zener diode
- D3, D4, D5, D6—1N34A diode
- Q1—3N84 silicon controlled switch
- Q2—2N3392 transistor

selection of the repetition rate is obtained by setting the range switch, S1, while fine and continuously variable control is obtained by setting potentiometer R3.

Capacitors C1 through C6, associated with the range switch, have a maximum step-to-step ratio no greater than 5, while R3 provides a resistance variation ratio of 6. Thus, there is adequate overlap of the repetition rate when going from one step of the range switch to the next one. The step ratio of 5 makes it unnecessary to use a vernier potentiometer in series with R3.

In an individual instrument, component tolerances affect the range of repetition rates to a certain extent. The lowest available repetition rate, for example, might be somewhere between 1.8 and 2.2 pps, assuming an accumulated tolerance of 10%. For most practical applications of the instrument, however, such variations are of no particular consequence.

Output from the SCS is taken at the cathode. Capacitor C7 and the resistance of potentiometer R7 differentiate Q1's output signal, thereby removing the "back porch" from the turn-off side of the waveform, at all except the highest repetition rates. Diode D1 reduces to a very low level the negative-going residue of the differentiation process. Potentiometer R7 is the output level control.

The signal at the slider of R7 is fed to the base of transistor Q2 via capacitor C8. Q2 operates as an emitter-follower to decouple the differentiator and to provide the instrument with a reasonably low output resistance. The signal fed to the output terminals is taken at the emitter of Q2 via capacitor C9. Maximum amplitude of the output pulse is about 4 volts at 1000 pps.

Construction

The prototype instrument is assembled in a 5" x 4" x 3" aluminum box, with most of the small components mounted on a printed-circuit card. Range capacitors C1 through C6 are mounted on a separate piece of phenolic and located adjacent to rotary switch S1.

R.f. wiring techniques are recommended in assembling the generator if it is to perform at its best. If difficulty is encountered in getting the SCS to operate over the full range of R3, that is, if pulsing ceases near either end of the adjustment, increasing or decreasing the value of the anode-gate resistor, R5, will cure it. The value of R5 given in the parts list is a compromise value which permitted several 3N84's in the author's possession to operate as required in the circuit. Thus, in the average assembly of the instrument, the value of R5 need not be adjusted.

Increase the value of R5 if pulsing ceases near the maximum-resistance

(lower-frequency) setting of R3; decrease it if pulsing ceases near the minimum-resistance (higher frequency) setting. It is inadvisable to use a larger value potentiometer for R3, since doing so may exceed the range which the SCS can accommodate and, in this event, no value of R5 can provide satisfactory operation at both ends of the adjustment.

The instrument is operated from a built-in miniature a.c. power supply, the internal resistance of which helps to limit d.c. flow through zener diode D2. The rest of the required limiting is supplied by series resistor R11. Output from the power supply is set at 7 to 8 milliamperes when the instrument is operated from a 117-volt a.c. power line. If a transformer rated higher than 10 mA at 12 volts is used in a particular assembly, the value of resistor R11 may be increased to limit the power-supply output to about 7.5 mA. Operation from a 12-volt battery is possible, if portability is desired. ▲

TROUBLESHOOTING THE QUASAR COLOR-TV

ACCORDING to Motorola, when the complaint is no raster and a check reveals that there is no high voltage on the TS-915 Quasar color-TV chassis, the possible cause is an open vertical fuse resistor (R2H), located on the convergence panel door.

The experts suggest that you use a voltmeter to check for 95 V at both terminals of the resistor. But—do not jumper the fuse terminals. If the resistor is open, check for a short at the load end. You should suspect a shorted vertical transistor.

The reasoning on this is that normally the fuse resistor protects the vertical output transformer and associated parts should the transistor short. A 40-volt supply is secured from this circuit through R10J at terminal J2-3. This 40 volts supplies the horizontal driver stage. Thus, if the fuse opens there will be no raster, due to no high voltage. The fuse not only protects the vertical output transformer, but it avoids a horizontal line if the vertical output transistor shorts and blows the fuse. ▲

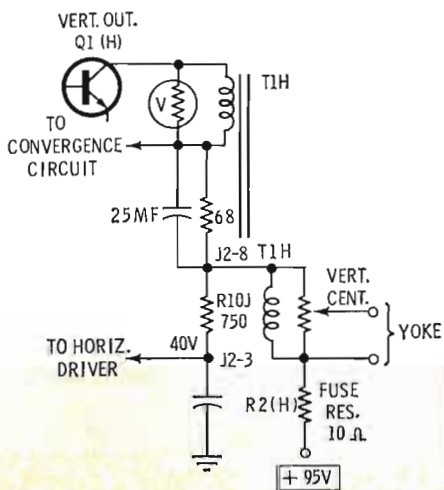

AMPLIFIER SHOPPING?

Try this checklist

DOES IT ALTER THE SOUND?

- low harmonic distortion
- all sounds accentuated evenly (flat response)
- adequate power to handle total dynamic range (note percussion and plucked strings, which require 30 times more power)

DOES IT ADD SOUNDS OF ITS OWN?

- no audible 60-cycle hum
- no power line noises

DOES IT SOUND NATURAL WITH MY SPEAKERS?

- practical performance, not theoretical (many amplifiers quoting outstanding specifications with a resistive load are distorted or unstable with some speakers)

WILL IT PERFORM RELIABLY?

- rugged, high-quality construction
- advanced but proven design
- adequate warranty protection

If you can check off all these points, then you're looking at a CROWN DC300 Amplifier -- the industry standard. Experience the notable difference at your audio specialist today. For a brochure and High Fidelity DC300 Equipment Report, write CROWN, Box 1000, Elkhart, Indiana, 46514. [Watch for the unveiling of CROWN's new Master Control -- a new-concept control center in the DC300 tradition of quality.]



CIRCLE NO. 141 ON READER SERVICE CARD

Can you solve these two basic problems in electronics?

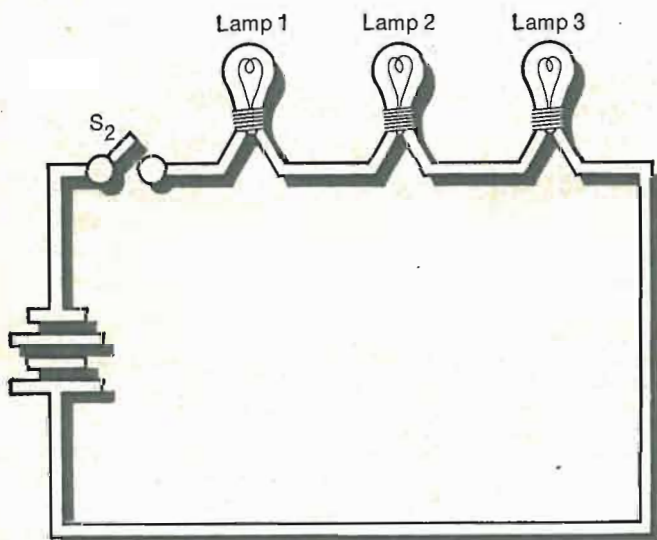

This one is relatively simple:

When Switch S_2 is closed, which lamp bulbs light up?

Note: If you had completed only the first lesson of any of the RCA Institutes Home Study programs, you could have solved this problem.

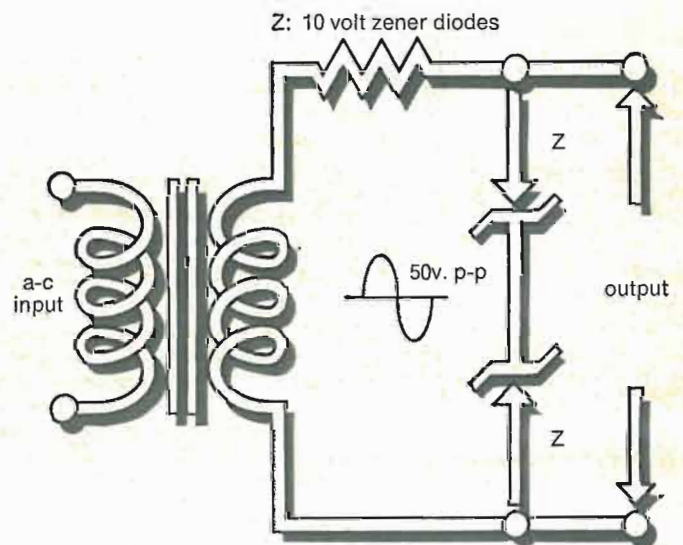

This one's a little more difficult:

What is the output voltage (p-p)?

Note: If you had completed the first lesson in the new courses in Solid State Electronics, you could have easily solved this problem.

These new courses include the latest findings and techniques in this field. *Information you must have if you are to service today's expanding multitude of solid state instruments and devices used in Television, Digital, and Communications Equipment.*

If you had completed an entire RCA Institutes Home Study Course in Semiconductor Electronics, Digital Electronics, or Solid State Electronics, you should now be qualified for a good paying position in the field you choose. Send for complete information. Take that first essential step now by mailing the attached card.

ANSWERS: Problem 1—they all light up
Problem 2—20 Volts (p-p)

RCA Institutes Autotext learning method makes problem-solving easier... gets you started faster towards a good-paying career in electronics

Are you just a beginner with an interest in electronics? Or, are you already making a living in electronics, and want to brush-up or expand your knowledge? In either case, RCA has the training you need. And Autotext, RCA Institutes' own method of Home Training will help you learn more quickly and with less effort.

Wide Range of Courses

Select from a wide range of courses. Pick the one that suits you best and check it off on the attached card. Courses are available for beginners and advanced technicians.

- Electronics Fundamentals
- Black & White Television Servicing (Transistorized TV Kit Available)
- Color Television Servicing (Color TV Kit Available)
- FCC License Preparation
- Automatic Controls
- Automation Electronics
- Industrial Electronics
- Nuclear Instrumentation
- Electronics Drafting
- Computer Programming

Plus these new up-to-the-minute courses

- Semiconductor Electronics
- Digital Electronics
- Solid State Electronics
- Communications Electronics

Prepare for good paying positions in fields like these

- Television Servicing
- Telecommunications
- Mobile Communications
- CATV
- Broadcasting
- Marine Communications
- Nuclear Instrumentation
- Industrial Electronics
- Automation
- Computer Programming
- Solid State
- Electronics Drafting



Build and keep this valuable oscilloscope.



In the new program on Solid State Electronics you will study the effects of temperature and leakage characteristics of transistors.



Variety of Kits—Yours to Keep

A variety of RCA Institutes engineered kits are included in your program of study. Each kit is yours to keep when you've completed the course. Among the kits you construct and keep is a working signal generator, a multimeter, a fully transistorized breadboard superheterodyne AM receiver, and the all-important oscilloscope. These 4 kits are at no extra cost. Compare this selection with other home study schools.

Two Convenient Payment Plans

Pay for lessons as you order them. No contract obligating you to continue the course. Or, you can take advantage of RCA's convenient monthly payment plan. No interest charges!

Classroom Training Also Available

RCA Institutes operates one of the largest technical schools of its kind. Day and evening classes. No previous training is required. Preparatory courses are available. Classes start four times a year.

Job Placement Service, Too!

Companies like Bell Telephone Labs, GE, Honeywell, IBM, RCA, Westinghouse, Xerox, and major radio and TV networks have regularly employed graduates through RCA Institutes' own placement service.

All RCA Institutes courses and programs are approved for veterans under the new G.I. Bill.

Send Attached Postage Paid Card Today. Check Home Study or Classroom Training.

Accredited Member National Home Study Council.

IF REPLY CARD IS DETACHED, SEND THIS COUPON

RCA Institutes Inc.

Home Study Dept. 240-001-0
320 West 31 Street
New York, N.Y. 10001

Please send me FREE illustrated career catalog.

Name _____ Age _____
(please print)

Address _____

City _____ State _____ Zip _____

MANUFACTURING ENGINEERING

Test Equipment Design
Production Troubleshooting

Automatic Electric, a leading innovator of computerized electronic switching systems and the largest producer of communications equipment for the independent telephone industry, has numerous entry level and experienced positions available for MANUFACTURING ENGINEERS.

We are seeking new and experienced degreed electronic or electrical engineers (or equivalent work experience) to initially learn new computerized electronic telephone switching systems, design test equipment and associated test procedures and trouble-shoot the mass-production of this equipment.

If you are interested in a progressive, growing company that offers well-equipped, modern facilities, a policy of promotion from within, and a pleasant Suburban location (17 miles West of downtown Chicago), send your resume in confidence to:

Larry Wisniewski
Professional Employment Representative

AUTOMATIC ELECTRIC
Subsidiary of General Telephone & Electronics
400 North Wolf Rd., Northlake, Illinois 60164

An equal opportunity employer

CIRCLE NO. 148 ON READER SERVICE CARD

NEW COAX WALL PLATES

For UHF/VHF
Color/B&W TV



A Simplified Approach to a single direct antenna lead-in receptacle for 75 ohm coax. Mosley's FCC-1PK TV antenna coax outlet & FCC-145PK with 4 or 5 wire rotor cable outlet assures Top Performing UHF/VHF and FM-Stereo. Designed with improved solderless connections. New FCC-Series Wall Plates are installed quickly and easily in minutes.

Write Dept. 167 for FREE detailed brochure

Mosley Electronics, Inc. 4610 N. Lindbergh Blvd.,
Bridgeton Missouri 63042

CIRCLE NO. 99 ON READER SERVICE CARD

BOOK REVIEWS

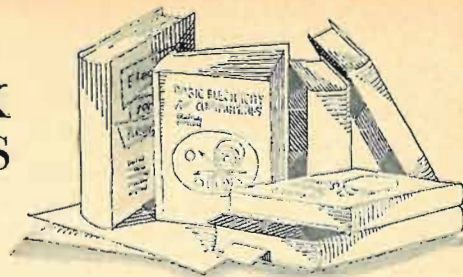

"ELECTRICAL FUNDAMENTALS" by Joseph J. DeFrance. Published by *Prentice-Hall, Inc.*, Englewood Cliffs, N.J. 692 pages. Price \$12.95.

This single volume is an updated version of the author's two previous books on direct-current and alternating-current fundamentals. Like the earlier works by this same author this volume is directed to students at technical institutes, community and junior colleges, and other pre-professional schools.

Presented in conversational style, the author has placed his major emphasis on concepts, not mathematical derivations, although not neglecting mathematics when required. The text is divided into two parts, dealing with d.c. and a.c. separately. There are seven appendices with material the student will need while working with the text. As is the case with most books designed for classroom studies, there are review questions at the end of each chapter so the student and/or teacher can check up on the student's grasp of the material.

* * *

"FM FROM ANTENNA TO AUDIO" by Leonard Feldman. Published by *Howard W. Sams & Co., Inc.*, Indianapolis, Ind. 153 pages. Price \$3.95. Soft cover.

This handy manual is based on a series of articles the author wrote for *Audio Magazine* and, as billed, covers the subject from the transmitting antenna to the receiving antenna, to the various circuits in the tuner.

The material is divided into nine chapters describing the differences between AM and FM, noise and interference in FM, signal propagation and receiving antennas, FM front ends, i.f. amplifiers and limiters, FM detectors, circuits refinements for FM, FM receiver measurements, and FM receiver alignment.

The text is lavishly illustrated.

*

"ZENITH COLOR TV SERVICE MANUAL" by Robert L. Goodman. Published by *Tab Books*, Blue Ridge Summit, Pa. 17214. 160 pages, plus 36-page schematic section. Price \$7.95 vinyl cover, \$3.95 paperbound.

This specialized service manual covers 28 Zenith chassis and includes complete manufacturer's service data and schematics for models ranging from the 27KC20 to the transistorized 14Z8C50.

The first seven chapters deal with basics such as setup and troubleshooting techniques, tuner, i.f. and a.g.c. circuits; chroma and video circuit troubleshooting; troubleshooting the deflection circuits; high-voltage and CRT screen color problems; sound and power-supply circuits; and i.f. and chroma alignment. The remaining twelve chapters are devoted to service notes for specific chassis. The schematic section provides full-size diagrams of the twelve most popular chassis. The text material is illustrated by partial schematics, waveforms, line drawings, photographs, and block diagrams. The large format permits the technician to consult the manual as he works on the set.

* * *

"RCA POWER CIRCUITS" compiled and published by *RCA Electronic Components*, Harrison, N.J. 07029. 439 pages. Price \$2.00. Soft cover.

This manual (Technical Series SP-51) has been expanded

and updated to include all the latest information on the characteristics, capabilities, and applications of solid-state power devices. Although prepared especially for circuit and system designers, the fact that it contains a lot of basic reference material makes it suitable for students, hams, educators, and experimenters as well.

The manual provides design information on a broad range of circuits that use power transistors, silicon rectifiers, and thyristors. It includes a brief look at semiconductor physics and offers detailed descriptions of the construction, theory of operation, important ratings and characteristics, and circuit applications for each type of device.

* * *

"ELECTRONICS: A GENERAL INTRODUCTION FOR THE NON-SPECIALIST" by G. H. Olsen. Published by *Plenum Press*, New York. 486 pages. Price \$17.50.

This volume is addressed to scientific workers who must use various types of electronic equipment but since they are not specialists in electronics are very often bewildered by this gear.

Without undue emphasis on mathematics or circuit theory, the author discusses passive components, circuit responses, active devices, indicating instruments, power supplies, thyratrons and SCR's, amplifiers, oscillators, CRO's, photoelectric devices, measuring instruments, logic circuits, and such practical considerations as maintenance and servicing.

The author is a Senior Lecturer in the Physics Department, Rutherford College of Technology in England so the text adheres to British terminology and usage and all of the illustrative material is drawn from English firms and publications. However, this should present no particular difficulty to the scientific community to which the author has addressed his book.

* * *

"ELECTRONIC SENSING CONTROLS" by Steven E. Summer. Published by *Chilton Book Company*, Philadelphia, Pa. 19106. 184 pages. Price \$8.95.

The author has tackled his subject by dividing his book into three main sections covering a review of common technology and electronics, a comparison of commonly used sensors and transducers, a review of basic electronic circuits including semiconductor diodes, transistors, and integrated circuits; the second section deals with basic types of controls—photoelectric, temperature, and electromechanical; and finally the effects of feedback on various sensing controls.

The treatment is such that plant managers and businessmen can obtain basic information on the automation of simple processes, while engineers will find the technical details invaluable.

* * *

"DIGITAL COMPUTER PRINCIPLES" by the Staff, Technical Training Dept., *Burroughs Corporation*. Published by *McGraw-Hill Book Company*, New York. 565 pages. Price \$8.95.

This is a revised and updated second edition of a book which originally appeared in 1962. Like the first edition, this text provides a broad survey of digital computer principles and elements of both the large and the small computing systems.

The new volume carries new material on thin film and thin film cryotron memories, integrated circuits, modularity concepts, displays, executive and control programs, multi-programming and multi-processing. The vacuum-tube circuits of the previous edition have been supplanted by solid-state circuitry in this volume.

The text is divided into three parts covering computer fundamentals, computer and peripherals, and programming and system concepts. The text is lavishly illustrated and each chapter carries a group of questions for the reader to test his grasp of the subject matter. Odd-numbered questions have answers provided. ▲

It's yours free

for the
asking!



**GIANT 274 PAGE
1970
RADIO-TV
ELECTRONICS
CATALOG**

YOUR BUYING GUIDE FOR . . .

TV's, Radios, Recorders, Phonos, Amateur and CB equipment, electronic parts, tubes and test equipment . . . featuring B-A's famous big bargain packed section!

Write to:

**BURSTEIN-APPLEBEE CO.,
DEPT. EW-1 3199 MERCIER ST.,
KANSAS CITY, MO. 64111**

Name _____

Address _____

City _____

State _____

Zip Code _____



CIRCLE NO. 146 ON READER SERVICE CARD

ActionLITE PUSHPINS LIGHT UP...

ACTUAL SIZE



GET YOUR MESSAGE ACROSS IN A FLASH!

Versatile NEW visual display system features **pushpins that light . . . even flash**. Your overlays of sales maps, production charts etc. mount easily on special cork-board surface backed with conducting Plasticon. (Board uses ordinary electric current.) Use ActionLITE pushpins to focus attention. The special surface is Magnetic too, to insure dramatic visual impact. ActionLITE pushpins and magnetic markers come in many sizes, shapes, colors. Boards range in size from 2'x3' to 4'x8'.

METHODS RESEARCH

200 WILLOW AVE.
STATEN ISLAND, N.Y. 10305
CIRCLE NO. 121 ON READER SERVICE CARD



Revox is impossible.

Impossible to describe that is. There is nothing we can say about the Revox that hasn't been said before, by some other manufacturer about his tape recorder.

Every machine from \$60 to \$6000 promises distortion free performance, from the sub-sonic to the ultra-sonic, with undetectable wow and flutter.

So what do we say... after they say they're perfect? Simply this:

Revox delivers what all the rest only promise.

If you would like the true facts on this remarkable machine, mail the coupon along with \$1 for the 64 page owners manual. It not only describes the Revox in detail, but amounts to a home study course in tape recording.

P.S. Your \$1 may be applied to the purchase price of your first Revox.



Revox Corporation
212 Mineola Avenue
Roslyn Heights, N.Y. 11577

Gentlemen:

Enclosed please find \$1 for the 64-page owners manual.

Name _____

Address _____

City _____

State _____ Zip _____

EW-1-70

CIRCLE NO. 116 ON READER SERVICE CARD
86

USING SILICON TRANSISTORS AS ZENERS

By J. CHARLES

You can use low-cost epoxy silicon transistors for good performance as low-voltage zener diodes.

HAVE you ever wondered why a zener diode should cost three to five times as much as some of the low-cost epoxy-packaged silicon transistors on the market? And why, especially with low-voltage zeners, you should have to put up with the fairly poor regulating characteristics of these expensive hooked-up-backwards diodes? If you use low-voltage zeners and these problems bother you, there's a way out of this dilemma: use those low-cost epoxy-packaged silicon transistors.

The base-emitter junction of most low-cost silicon transistors makes an excellent 5 to 10 volt zener diode when biased in the reverse direction. Some are excellent regulators, with turn-on occurring very sharply below 10 μ A; annular devices tend to be much better in this respect than devices fabricated otherwise. The B-E junction of most silicon transistors tends to exhibit excellent zener characteristics, but we'll limit this discussion to what you can expect from the low-cost types (in one instance silicon transistors have been used as zeners on a space program).

Figs. 1 and 2 show the zener characteristics of the base-emitter junctions of three epoxy-packaged silicons. You'll have to check to determine the actual breakdown voltage of the device you use, but a few hints ought to help.

1. Manufacturer's specs won't give the exact zener voltage. The base-emitter breakdown tends to be a few volts higher than the V_{EBO} rating. For ex-

ample, the V_{EBO} for an MJE340 and 2N3904 are, respectively, 3 and 6 volts. According to our curves, the V_{EBO} 's are actually 6 and 8 volts.

2. Once you have determined the breakdown voltage, the value tends to hold fairly well among other devices with the same number and from the same manufacturer.

3. The "n-p-n" silicon devices tend to have higher breakdown voltages than "p-n-p". Keep this fact in mind when you need a V_Z of from 7 to 10 volts.

To get the zener effect in the base-emitter junction, remember that it has to be reverse-biased. This means that, for an "n-p-n" device, the emitter is

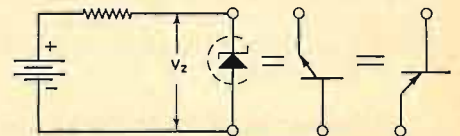

Fig. 3. The zener equivalence of "n-p-n" and "p-n-p" transistors.

made more positive than the base, and *vice versa* for a "p-n-p". See Fig. 3.

In most instances, the maximum current you can pump through the transistor-zener is limited by package dissipation. For most small-signal transistors this figure is 200 to 400 mW. If you have a device with a V_Z of 8 V and a 200-mW package, then $I_{max} = 200 \text{ mW}/8 \text{ V} = 25 \text{ mA}$. Always check the specs to make sure your calculation of I_{max} is consistent with the maximum collector current rating of the device.

If you need a higher current capability, don't overlook the high-power epoxy units available from several makers—for example, *Motorola's* MJE340. In this case, maximum current is set by the maximum collector current of the device (500 mA) and not by device dissipation (21 watts). Don't forget to heat-sink these high-power units as they get quite warm when running at their V_Z and higher currents. Also the MJE340 exhibits a phenomenon of rather sharp breakdown at low current levels. The device undergoes a 1 V change in breakdown voltage from 10 μ A to 500 mA. This sounds rather drastic, but results in a dynamic impedance of only 2 ohms. Of course, you can see from the curves that the voltage change is much less over a less drastic current range. ▲



Fig. 1. Base-emitter V-I characteristics of the "p-n-p" 2N3905 (left) and "n-p-n" 2N3904 (right) silicon transistors. In both cases H is 1 V/div., V is 1 mA/div.

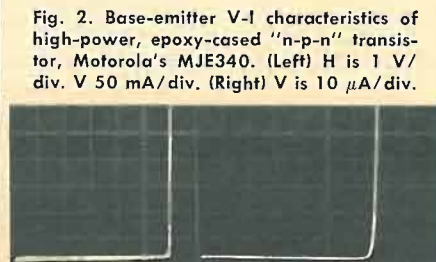

Fig. 2. Base-emitter V-I characteristics of high-power, epoxy-cased "n-p-n" transistor, *Motorola's* MJE340. (Left) H is 1 V/div. V 50 mA/div. (Right) V is 10 μ A/div.

THE TAPE RECORDER EXPERT!
Stereo Review's
1970 TAPE RECORDER ANNUAL



Your own personal expert on tape recorders and tapes.

This big, illustrated volume is crammed with expertly written features about tape recorders and tape buying, maintenance, editing and recording technique.

TAPE RECORDER ANNUAL has everything—fresh and lively features including a picture article that takes you through the manufacturing process of pre-recorded tape • Cassettes at home and abroad • Stop—and-go realties of tape in the law • Buying guides to help you choose: guides to open reel, cassette and cartridge . . . tape recorders and decks . . . mikes and accessories. There's action on everything in **TAPE RECORDER ANNUAL**—test tapes • tapping off the air • maintenance procedures • manufacturers' index • oscilloscopes as a recording level meter plus a complete glossary of tape terminology. This is the annual you'll want to have, and save . . . and refer to again and again, all year.

Ziff-Davis Service Division, Dept. TRA EW-1-70
595 Broadway, New York, N.Y. 10012
Please send my copy of the 1970 TAPE RECORDER ANNUAL as checked below:

- \$1.35 enclosed, plus 25¢ for shipping and handling. Send me the regular edition. (\$2.00 for orders outside the U.S.A.)
- I am enclosing \$3.50. Please send me, postpaid, the Leatherflex-covered Deluxe Edition. (\$4.50 for orders outside U.S.A.) (Please allow 3 additional weeks for delivery of the Deluxe Edition.)

print name _____
address _____
city _____
state _____ zip _____

— PAYMENT MUST BE ENCLOSED WITH ORDER —

For a SOUND INVESTMENT . . . you need SOUND ADVICE

1970 STEREO HI-FI DIRECTORY



It's the most complete, most reliable guide to virtually every new component on the market — amplifiers

- tuners • receivers • changers and turntables
- home TV-tape recorders • cartridges-arms and accessories
- tape machines-cartridge, cassette and reel-to-reel • speaker/cabinets • hi-fi systems • miscellaneous accessories.

You'll know what to look for, what to listen for, how to buy, what to pay—before you set foot into the store. You'll be armed with full technical specs, photos, model numbers, dimensions, special features, optional accessories, and prices for each piece of stereo equipment put out by the world's leading manufacturers.

Even if you plan to buy just one piece of equipment in the next 12 months, the 1970 Stereo Hi-Fi Directory is your most important first step. A must for anyone concerned with good listening . . . and sound buying!

Ziff-Davis Service Division, Dept. SD EW-1-70
595 Broadway, New York, N.Y. 10012
YES. Send me the new 1970 STEREO HI-FI DIRECTORY as checked below:

- \$1.35 enclosed, plus 25¢ for shipping and handling. Send me the regular edition. (\$2.00 for orders outside the U.S.A.)
- \$3.50 enclosed. Send me the Deluxe Leatherflex-bound edition, postpaid. (\$4.50 for orders outside the U.S.A.) Allow three additional weeks for delivery.

print name _____
address _____
city _____
state _____ zip _____

— PAYMENT MUST BE ENCLOSED WITH ORDER —

Sensitive Intrusion Alarm

By FRANK H. TOOKER

SHOWN in the schematic below is a simple, yet very sensitive intrusion alarm which can add a measure of protection to anyone's home. It is equally valuable while traveling. The unit combines a 2800-Hz wail of a "Sonalert" alarm with the very sensitive triggering characteristic of a silicon controlled switch (SCS) operated at low current levels. The mere touch of a fingertip is all that is needed to trigger the alarm, which will continue to wail until the "Reset" push-button is pressed.

Triggering is accomplished at the cathode-gate of the SCS. This electrode is directly connected to the inner connector of an RCA-type jack, J1. A length of lapel-mike coax cable, fitted with a plug to engage the jack, has its inner conductor at the far end connected to, for example, a metal doorknob. Anyone touching the knob will immediately trigger the alarm. The author has used lengths of cable up to 25 feet without decreasing the reliability of this alarm.

Although current consumption is low, maximum sensitivity will be realized only when the device is operated from an a.c. power supply. This is because the alarm is triggered by the voltage induced on the human body (or any other conductor of electricity) by electrostatic coupling with the power line. The unit becomes quite sluggish when operated from a battery. Some improvement in sensitivity may be obtained by grounding the circuit to a cold-water pipe, but the result will not be as good as when an a.c. power supply is used.

The 0.01- μ F capacitor, connected between the anode and anode-gate of the SCS, helps to keep the alarm from being triggered by transient voltage spikes arriving via the power line.

The one disadvantage of the intrusion alarm is that it can be made inoperative by a person wearing gloves, although not necessarily so if the gloves are damp, since it takes only a minute amount of current to trigger the SCS.

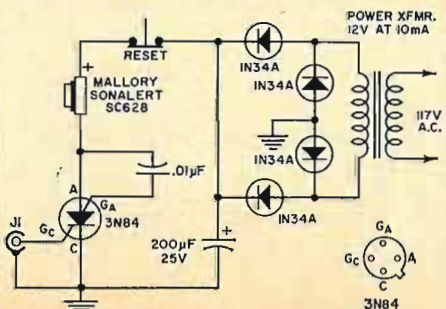

LIBERTY PAYS MORE! WILL BUY FOR CASH

- ALL TYPES:
- ★ ELECTRON TUBES
 - ★ SEMICONDUCTORS
 - ★ TEST EQUIPMENT
 - ★ Military Electronic Equipment
- WIRE—WRITE—PHONE COLLECT!
We pay freight on all purchases—

LIBERTY OFFERS MORE! PRESTEL FIELD STRENGTH METER

(Model 6T4G)

Only
\$120.00

F.O.B.
New York



- ★ Never Anything Like It!
- ★ 1-Man Can Do A Better Job than 3 in the Same Time!
- ★ A Gold-Mine for Antenna Installers!
Calibrated from 40 to 230, and 470 to 860 in 4 Bands Megahertz, from 10 to 50,000 Microvolts. Nothing makes it easier to properly and speedily find the correct place to install TV, FM and Communication Antennas. You can measure and hear the signals with this 4½ volt battery economically powered unit.

LIBERTY ELECTRONICS, Inc.

548 Broadway, New York, New York 10012
Phone (212) 925-6000

CIRCLE NO. 123 ON READER SERVICE CARD

STATEMENT OF OWNERSHIP, MANAGEMENT AND CIRCULATION (ACT OF OCTOBER 23, 1962; SECTION 4369, TITLE 39, UNITED STATES CODE).

1. Date of filing: October 1, 1969. 2. Title of publication: Electronics World. 3. Frequency of issue: monthly. 4. Location of known office of publication: 307 N. Michigan Avenue, Chicago, Illinois 60601. 5. Location of the headquarters or general business offices of the publishers: One Park Avenue, New York, New York 10016.

6. Names and addresses of publisher, editor, and managing editor: Publisher, Phillip T. Heffernan, One Park Avenue, New York, New York 10016; Editor, William A. Stocklin, One Park Avenue, New York, New York 10016; Managing Editor, Milton S. Snitzer, One Park Avenue, New York, New York 10016.

7. Owner: Ziff-Davis Publishing Company, One Park Avenue, New York, New York 10016; William B. Ziff, One Park Avenue, New York, New York 10016.

8. Known bondholders, mortgagees, and other security holders owning or holding 1 percent or more of total amount of bonds, mortgages or other securities: None.

10. Extent and nature of circulation:

	Average No. Copies Each Issue During Preceding 12 months	Single Issue Nearest to Filing Date
A. Total no. copies printed (net press run)	233,822	225,624
B. Paid circulation		
1. Sales through dealers and carriers, street vendors and counter sales	37,867	37,600
2. Mail subscriptions	139,340	140,865
C. Total paid circulation	177,207	178,465
D. Free distribution (including samples) by mail, carrier or other means	1,754	1,657
E. Total distribution (sum of C and D)	178,961	180,122
F. Office use, left-over, unaccounted, spoiled after printing	54,861	45,502
G. Total (Sum of E & F — should equal net press run shown in A)	233,822	225,624

I certify that the statements made by me above are correct and complete.
WILLIAM PHILLIPS, Assistant Treasurer

LAUNCHING
THE
SPECTACULAR



IN ELECTRICAL and
ELECTRONICS ENGINEERING

4 Floors of Exhibits
NEW YORK COLISEUM

50 Technical Sessions
NEW YORK HILTON

Monday
through
Thursday



INTERNATIONAL
CONVENTION and EXHIBITION
MARCH 23-26, 1970

CIRCLE NO. 130 ON READER SERVICE CARD

Why does **GBC** sell
more replacement vidicons
than all other suppliers
combined?

Because GBC offers top
quality, fully guaranteed,
factory sealed vidicons for
less than half the price you'd
have to pay anywhere else!

HITACHI 7038H 29.50

HITACHI 7735A
High sensitivity 34.50

HITACHI 7262
(Replacement for Sony
& Panasonic) 34.50

HITACHI 8507
(Separate mesh) 74.50

All vidicons sold in lots of five.
Add 10% for lesser quantities.

GBC Closed Circuit TV Corp.
74 Fifth Avenue, N.Y., N.Y. 10011 / (212) 989-4433

CIRCLE NO. 135 ON READER SERVICE CARD

Testing VW's Electronic Fuel-Injection System

By FRED W. HOLDER & R. DAVID SPRINGS

THE electronic fuel-injection system furnished as standard equipment on 1968 *Volkswagen* fast- and square-back models was developed jointly by *Volkswagen* and *Robert Bosch* of Germany who are licensed under the basic patents on fuel injection held by *Bendix*. In a previous article (November, 1968 issue), it was mentioned that this system was designed to provide simplified maintenance procedures. All components are factory interchangeable so that major, complex adjustments are not required whenever a component is replaced.

Robert Bosch developed a test unit and a test program to ensure that the system is checked out properly. Most of this test program is static in nature and can be conducted using only a v.o.m. and a 30-psi gage. This article outlines a method by which the fuel-injection system may be checked out using these two items of test equipment.

If your VW is still under warranty, let your VW dealer take care of it. Also, if it is working properly, leave it alone. A good guide to system performance is a fuel mileage record based on the use

of low-priced major fuel brands over a period of five or six full tanks. A downward trend in mileage indicates a performance problem. By making adjustment changes to your system one at a time and checking these with the mileage record, you can evaluate the effect of the changes and develop the greatest performance potential from your system.

Before checking the fuel-injection system, when there is a performance problem, make sure the ignition system is properly adjusted. Ignition adjustment seems to be rather critical on these models.

To prepare the system for testing, you must remove the computer from the left-hand side of the rear luggage compartment. (*Caution:* During this step, make sure the ignition is switched off.) Loosen the left-hand trim of the rear luggage compartment, remove the panel, and raise the flap that covers the computer. This will expose the black cover that holds the computer in place. Remove the two upper *Phillips* screws in the black cover panel, tilt the computer, and lift it upward and out.

Table 1. Rundown on the tests to be performed to check fuel-injection system.

TEST STEP	OPERATING CONDITION	ITEM TO BE TESTED	METER CONNECTIONS (Multiple Connector Pins)		READING ON METER
			POSITIVE	NEGATIVE	
1.	Ignition "on"	System power	24	11	11 to 12.5 V d.c.
			16	11	11 to 12.5 V d.c.
2.	Starter operating	Cold start signal	18	11	9.5 to 12 V d.c.
3.	Not applicable	Pressure sensor	8	10	Approx. 90 ohms
			7	15	Approx. 350 ohms
4.	Starter operating	Distributor contacts	21	12	Alternate between 0 and ∞ ohms
			22	12	
5.	Throttle closed	Throttle switch	17	20	0 ohms
6.	Throttle open more than 2°	Throttle switch	17	20	∞ ohms
7.	Not applicable	Crankcase temperature sensor	23	13	Approx. 300 ohms at 68°F. Varies with temperature.
8.	Not applicable	Cylinder head temperature sensor	1	13	Approx. 2500 ohms at 68°F. Varies with temperature.
9.	Not applicable	Injector windings	3	11	2.4 ohms at 68°F.
			4	11	
			5	11	
			6	11	

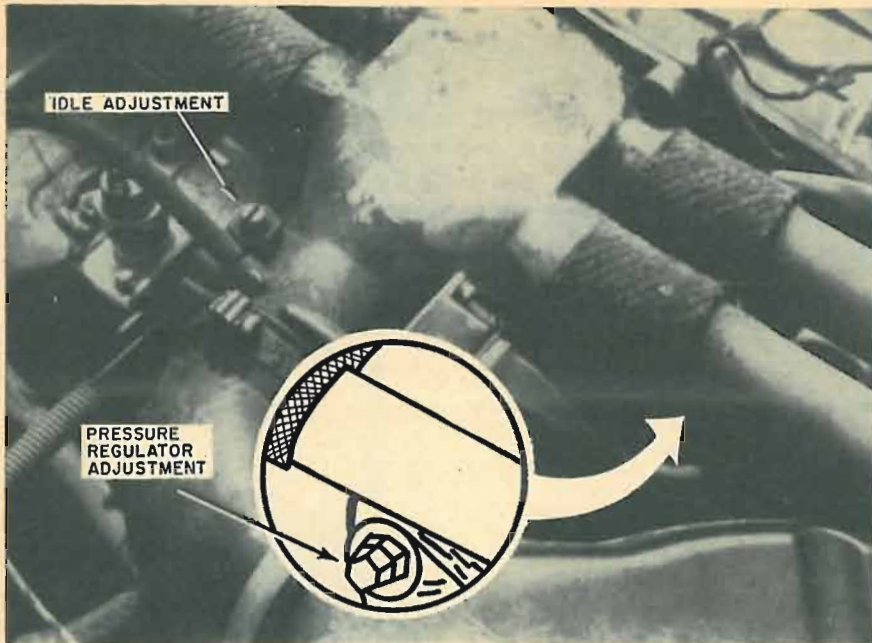

Fig. 1. Adjustments on Volkswagen's fuel-injection system. Refer to the text.

Now, open the cable clamp on the computer and remove the connector cover by sliding it toward the cable clamp. Grasp the multiple connector and pull it straight out. (*Caution:* Take care that you don't tilt the connector while removing it.) You may now check out the electrical components of your system, except the computer, by making the measurements listed in Table 1.

The next test measures the performance of the fuel-pressure regulator, which is very important because fuel pressure affects both fuel consumption and exhaust gas composition. To check the pressure regulator, you will need a 30-psi gage. You must adapt this gage to connect into the regulated side of the fuel system. You must fit this gage with a piece of 1/4-in i.d. fuel hose about 6 inches long, remove the screw in the standpipe located at the junction where the fuel line splits for injectors 1 and 2 (right side), and push the fuel hose onto the standpipe. The fuel hose will stay put at 28 psi.

After you have installed the gage, energize the fuel pump by turning on the ignition and momentarily jumpering pins 16 and 19 on the multiple connector. The pressure should measure 28 psi and it should hold at that pressure (un-

less there are leaks in the fuel system) when the jumper between pins 16 and 19 is removed.

The pressure regulator is adjusted while the engine is running. If you must make this adjustment, turn off the ignition, reconnect the connector to the computer, and re-install the computer in the left-hand side of the rear luggage compartment. With the pressure gage still connected into the system, start the engine and let it idle, back off the locknut on the pressure-regulator adjustment screw (see Fig. 1), adjust the hexagon screw so that the gage reads 28 psi, and retighten the locknut.

The final adjustment is engine-idle speed. Allow the engine to warm up to operating temperature and back off the locknut on the idle-adjustment screw (see Fig. 1). Then, set the idle speed between 850 and 900 r/min and retighten the locknut.

You have now checked out all electrical components, except the computer, and completed all system adjustments. Checking the computer can only be done properly by the *Bosch* factory; therefore, if everything else checks out and you still have problems in your fuel-injection system, it will probably be necessary to replace the computer. ▲

FM RADIO USAGE HITS NEW HIGH

THE FM share of the radio market continued to grow in 1968, registering increases and new highs.

FM radios accounted for 37.1% of all domestic-label receivers in 1968, as compared with 33.5% in 1967. In numbers, FM radios grew from 4.21 million table, clock, and portable receivers in 1967 to 4,322,000 units in a total domestic-label radio market that decreased from 12.6 million units in 1967 to 11.7 million in 1968.

Measured in dollars, FM accounted for 56.4% of the factory value of all domestic-label radios in 1968 as against 55% in 1967.

The FM share of the auto radio market increased from 940,000 or 10% in 1967 to 1,369,000, or 11% in 1968.

Total imports of all types of FM radios were up from 8,962,000 in 1967 to 13,890,000 last year. All of these figures, supplied by EIA, are for factory sales for the years quoted. ▲

Electronics World SUBSCRIBER SERVICE

Please include an address label when writing about your subscription to help us serve you promptly. Write to: Portland Place, Boulder, Colorado 80302

CHANGE OF ADDRESS:

Please let us know you are moving at least four to six weeks in advance. Affix magazine address label in space to the right and print new address below. If you have a question about your subscription, attach address label to your letter.

TO SUBSCRIBE:

- Check boxes below.
- New Renewal
- 5 years \$26
- 3 years \$18
- 1 year \$7

SPECIFY:

- Payment enclosed—
You get 1 extra issue per year as a BONUS!
- Bill me later.

← AFFIX LABEL →

state	city	address	name	If you have no label handy, print OLD address here.
zip-code	please print			
[Add'l postage: \$1 per year outside U.S., its possessions & Canada.]				
name				

name please print 03 23

address

city

state zip-code

Earn Your Degree

ELECTRONICS ENGINEERING

through HOME STUDY

HIGHLY EFFECTIVE HOME STUDY COURSES IN:

- Electronics Engineering Technology
- Electronics Engineering Mathematics

Earn your Associate in Science Degree in Electronics Engineering and upgrade your status and pay to the engineering level. Complete college level courses in Electronics Engineering. We're a forward looking school. Outstanding lesson material—thorough and easy to understand. Engineering taught on the basis of application and understanding rather than on the basis of memorization. Up to date in every respect. Acquire the knowledge and ability that means the difference between a low paying technician job and a high paying engineering position. Low tuition cost with low monthly payments. Free engineering placement service for our graduates. Write for free descriptive literature. Ask for bulletin J, no salesman will call on you.

COOK'S INSTITUTE
of Electronics Engineering
 Forest Hill Road
 P. O. Box 10634
 Jackson, Miss. 39209
 Established 1945
 Formerly Cook's School of Electronics

CIRCLE NO. 142 ON READER SERVICE CARD

NEW PRODUCTS & LITERATURE

For additional information on items identified by a code number, simply fill in coupon on Reader Service Card. In those cases where code numbers are not given, may we suggest you write direct to the manufacturer.

COMPONENTS • TOOLS • TEST EQUIPMENT • HI-FI • AUDIO • CB • HAM • COMMUNICATIONS

AUTO CASSETTE PLAYER

The Sony Model 20 stereo automobile cassette player weighs only 7 pounds and permits up to two hours of distortion-free listening.

The new unit features an exclusive "Insta-Load" facility with a push-in front loading opera-



tion that permits one-hand insertion of cassettes. The cassettes can be inserted without the driver taking his eyes off the road.

Dynamic music power output is 18 watts, permitting the use of high-quality speakers. Other features include automatic cassette ejection, program search capability with fast-forward and rewind, complete compatibility with any pre-recorded mono or stereo cassette, and stereo balance, tone, and volume controls.

The unit will operate in any car with a 12-volt positive or negative ground. It comes with a car mounting bracket, hardware and a head-cleaning pen. Superscope

Circle No. 6 on Reader Service Card

REPLACEMENT COLOR CRT's

A new line of replacement color tubes has been introduced as "Ultracolor." There are 13 different CRT types in six basic rectangular tube sizes: 11-, 19-, 21-, 22-, 23-, and 25-inch. A 21-inch round tube size featuring six types is also available.

The tubes are made to offer all of the essential original-equipment specifications. They use rare earth phosphor (except for certain older types clearly identified as having sulfide phosphor), have new electron guns, and may or may not utilize used glass and other materials. New and rebuilt tubes are clearly identified. GE

Circle No. 7 on Reader Service Card

NEW V.O.M.

The Model 202 "Accu-Log" v.o.m. has a quasi-logarithmic scale which gives consistent percent of reading accuracy at $\pm 2\%$ for d.c. values and $\pm 3\%$ for a.c. values. Easy zero adjustment is made on a linear portion of the low end of the scale.

Eliminating the need to keep readings at the



high end of the scale, ranges overlap to let the operator place the value being measured nearer mid-scale. There are six d.c. voltage ranges, four a.c. ranges, five d.c. current ranges, and five resistance ranges. Two of the resistance ranges are designated for low-power testing: R x 1 (4 ohm center, 2.7 mW maximum load) and R x 10 (40 ohm center, 0.25 mW maximum load).

Complete details on the Model 202 will be forwarded on request. Simpson Electric

Circle No. 8 on Reader Service Card

SPEAKER SYSTEM

The Model LWE IV "Texan" speaker system features four 15" woofers, four 8" mid-bass, four 6" midrange, and two 5" horn tweeters, housed in a walnut cabinet measuring 51½" high x 36¼" wide x 20" deep, including the kick base.

Crossovers are at 150, 1000, and 4000 Hz. Frequency response is 20-20,000 Hz ± 3 dB. The crossover network is an air-core high level unit. Nominal impedance is 4 ohms. The system will handle 200 watts r.m.s. with 100 watts r.m.s. per channel the minimum power requirement.

Controls are room gain, mid-bass, midrange, high-frequency, and phase. The main input is used for standard stereo operation while the auxiliary amp input is for bi-amping without low-level crossover.

The walnut cabinet comes with a removable wood fret grille. Acoustron

Circle No. 9 on Reader Service Card

STEREO RECEIVERS

Three new stereo receivers which differ only in available output power have been introduced as the Models SR-300 (12 W/ch), SR-400 (25 W/ch), and SR-600 (40 W/ch). All measurements are IHF standard music power, feeding into an 8-ohm resistive load.

All three units use silicon transistors throughout, have a signal-to-noise ratio of better than 60 dB, and complete input and output facilities; including outputs for tape deck or recorder, and speakers, and inputs for every high-level and



low-level source (in matched stereo pairs) including magnetic and piezoelectric phono cartridges.

All units feature stereo indicators and automatic mono/stereo switching and automatic defeat. A center-channel tuning meter is provided for FM and AM operation, while there are individual bass and treble controls for each channel. Balance and master volume controls, scratch filters, headset output, interstation muting filter, and equalization controls are all located on the front panel. Hitachi

Circle No. 10 on Reader Service Card

PORTABLE METERS

A new line of voltmeters, ammeters, and wattmeters has been introduced by SEP Instruments, 310 Madison Ave., New York, N.Y. 10017.

With an accuracy of 0.5%, these instruments have been designed to serve as master meters, secondary standards, or wherever precise electrical measurement is required. All meters feature



double spring-loaded, industrial sapphire jewel bearings and mirror scales with knife-edge tantalum pointers.

Direct-current meters are moving-coil instruments with a sensitivity of 5000 ohms/V while the a.c. meters are moving-iron instruments with a 0.5% accuracy from 15 to 100 Hz.

Full descriptive literature on the entire line will be forwarded to those making a request on their business letterheads.

HEAVY-DUTY MEGAPHONE

A heavy-duty megaphone, designed for police, fire fighting, recreational, commercial, and general p.a. applications is now available as the Model MV-20S.

This solid-state electronic amplifier can project a voice over the length of ten football fields. It may be used either hand-held or carried over the shoulder on a strap. "Talk" switches are located both on the unit's pistol-grip handle and on the detachable, weatherproof dynamic microphone. The unit also has a built-in siren alarm for warning alert, signaling, and distress service.

The megaphone operates on 12 volts from eight "C" cells or, with an optional adapter cord, from a cigarette lighter jack in a car or boat. The unit measures approximately 9" x 15" and shipping weight is 9 pounds. Fanon

Circle No. 11 on Reader Service Card

MONITOR RECEIVER

The PRO-20 monitor receiver, which tunes the 30-50 and 152-174 MHz bands, is designed for fire, police, taxi, and emergency operators and can be used to pick up ESSA's continuous weather forecasts on 162.55 MHz.

This FM communications receiver contains a complete tuning system with a color-coded scale for each band. Its 28-semiconductor circuit needs less than 0.5- μ V input and can deliver 2 watts of audio to the built-in speaker or to 8-ohm external phones or speaker. A squelch control limits noise for band monitoring.

The receiver measures 12¼" x 9" x 3¼" and is housed in a cabinet with brushed aluminum panel. Radio Shack

Circle No. 12 on Reader Service Card

MOBILE MONITOR ANTENNAS

Four new mobile antennas have just been added to the line of monitoring antennas to bring the series up to a total of 14.

The "Quick-Grip" unit, for both professional

and CB services, comprises a stainless steel cup base using a clamp-on device for the trunk lip so that no holes have to be drilled. The cup completely conceals the cable. The Model MON-13 covers all frequencies from 25 to 174 MHz, while the Model MON-14 is for low-band operation.

An all-band cowl-mount model is available as MNO-10. The Model MON-12 for multi-band use has a stainless steel gutter clamp for temporary applications. Antenna Specialists

Circle No. 13 on Reader Service Card

LUBRICANT/CLEANER

A new lubricant/cleaner has been developed and is being marketed as "Tun-O-Foam." It carries with it a unique six-month no-callback guarantee. Designed for all tuners, the product is available in 8-ounce cans. Chemtronics

Circle No. 31 on Reader Service Card

PHILLIPS-TYPE SCREWDRIVERS

A new line of Phillips-type screwdrivers with specially treated "super-tru" tips with exceptional dimensional accuracy has just been introduced. Finished in black oxide, the tips provide a close fit in screwhead recesses. According to the company, tip life is greatly improved and the possibility of damage to fasteners, especially the smaller sizes, is substantially reduced.

The screwdrivers are furnished with black plastic handles and are available in #0, #1, and #2 point sizes and five over-all lengths from 4⁵/₈" to 14¹/₈".

Catalogue 166 Supplement contains complete details and specifications. Xcelite

Circle No. 14 on Reader Service Card

SOLID-STATE 5-IN SCOPE

A wide-band, triggered-sweep 5-inch oscilloscope/vectorscope is now available as the Model



TO-50. Designed for TV servicing, production testing, communications work, and engineering labs, the new unit features a 10-MHz bandwidth, d.c. amplifiers to eliminate pattern bounce and permit viewing a.c. and d.c. simultaneously, calibrated vertical attenuator and horizontal time base, automatic sync mode, TV sync selector, vectorscope input for color-TV servicing, 60-Hz horizontal sweep with phasing control, and an edge-lighted calibrated scale.

The all-solid-state unit, with tube-protected input, measures 14¹/₈" high x 10¹/₄" wide x 16¹/₂" deep. It weighs 23 pounds. Lectrotech

Circle No. 15 on Reader Service Card

SOLID-STATE STEREO AMP

The AU555 stereo amplifier features SEPP-ITL-OTL circuitry with an output of 60 watts music power (IHF) and 25 W/channel r.m.s. power at 4 ohms. A new dividing system is incorporated which assures a power bandwidth of 20-30,000 Hz with less than 0.5% HD over the entire frequency range.

Negative feedback amplifiers are used in all stages to provide high S/N ratio and reduced

distortion. The main amplifier has a frequency response of 20-80,000 Hz. The preamplifier output has a distortion of less than 0.1% at the rated output voltage.

A special 2-position damping factor selector switch permits matching the damping factor to the characteristics of any speaker system.

Complete specifications and performance curves are available on request. Sansui

Circle No. 16 on Reader Service Card

HIGH-POWER COLOR ORGAN

An all-solid-state color organ incorporating silicon circuitry features triac power output stages

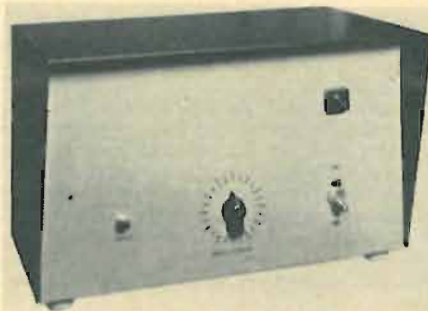

and active RC filters for quality channel separation. The four-channel unit can operate 600 watts of lighting on each channel on a continuous-duty basis.

The organ is housed in a rugged steel cabinet with a walnut wood-grain front panel. The rear apron has eight a.c. outlets, two per channel, for ease in distributing the light load. Each channel is individually protected by a fuse.

The unit may be operated by connecting it across any loudspeaker. A microphone accessory unit is also available for actuation by direct sound pickup. Edison Instruments

Circle No. 17 on Reader Service Card

LOGIC-CIRCUIT PROBE

A new hand-held probe for computer logic testing has been introduced as the "Acro-Probe."

Used in field servicing and assembly-line logic circuit testing and evaluation, the unit operates by simply touching the probe tip to a 0-state or 1-state terminal. Precise indication of circuit status is presented by a probe-top red light, green light, combination of lights, or no light.

The probe measures 8¹/₄" to the probe tip and weighs 7 ounces. It is constructed of unbreakable polycarbonate material. The system is designed for operation in the 3 V to 7 V range but range extenders for 7-16 and 16-30 volt operation are available. Acron Corp.

Circle No. 18 on Reader Service Card

CONTINUITY TESTER

A compact, lightweight continuity tester has been introduced as the "Bleeptest." Designed to meet the requirements of a wide variety of production, maintenance, and laboratory applications, the unit provides an audible confirmation of circuit continuity. A special sonic signal generator provides a low energy level through the circuit under test but generates no REI.

The instrument is housed in a high-impact plastic case with a stainless-steel clothing clip as well as an eyelet for lanyard suspension. All fastening hardware is captive. Socket connections for test leads accept standard banana plugs. A pair of color-coded split plugs is included. The unit operates from any standard 9-volt transistor radio battery. C. A. Briggs

Circle No. 19 on Reader Service Card

BURGLAR ALARM

The "Detectron" is a fully transistorized electronic security system that combines three alarm systems: radar, stress sensor, and perimeter, in a single master control.

The alarm can be tuned to the particular installation, depending on the area the owner wishes it to cover. Range and sensitivity can also be varied. The alarm activates practically any

Which of these 4 fascinating Radio-TV careers



interests
you?

- disc jockey
- newscaster
- sportscaster
- announcer

Our Free Voice Analysis Tells You Whether You Have The Talent To Become A Broadcast Personality!

IMMEDIATE DEMAND • Radio-TV stations everywhere need both men and women to take over important good-paying jobs right now. **NATIONWIDE PLACEMENT ASSISTANCE** at No Extra Cost.

TRAIN AT HOME OR IN ONE OF OUR STUDIO SCHOOLS • You can study broadcast techniques at home, in your spare time, or in one of our many studio schools throughout the country under the supervision of our Directing Faculty of 11 Famous Broadcasters. **Accredited Member National Home Study Council and National Association of Trade and Technical Schools.**

Approved for Veterans' Educational Assistance Benefits ("G.I. Bill")! Check coupon for special information

Send to CAREER ACADEMY's division of famous broadcasters for free booklet, record and voice analysis details!

CAREER ACADEMY

825 North Jefferson Street • Dept. NT35201
Milwaukee, Wisconsin 53202

I want to know if I have broadcasting aptitude worth developing. Please rush more information.

name age

address phone

city, state / zip

I am interested in: Home Study
 School Study G. I. Bill

CIRCLE NO. 145 ON READER SERVICE CARD

FINEST QUALITY HARD-TO-FIND TOOLS

NEW 1970 CATALOG

Unique collection of hard-to-find versatile hand tools and small power tools rarely found in stores or other catalogs. Large selection of new and unusual electronic tools and woodworking tools including pliers, knives, diamond glass cutters, soldering jigs, tungsten carbide saw blades, silver solder, micro miniature tools and scores of other fascinating items to make projects easier, more fun. All are top quality with money back guarantee. Used extensively by electronic technicians, researchers, model makers. Write to:

BROOKSTONE CO.

1065 Brookstone Building, Peterborough, N.H. 03458.

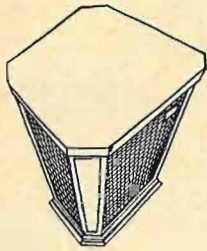

Where
do you
put
your
speakers
in a
room
shaped
like
this?

No matter what shape your room is in, Scott's new Quadrant Q-100 speakers solve your placement problems. Scott Quadrants, with two woofers and four midrange / tweeters placed around the enclosure's four sides, project full-frequency sound in a complete circle. The sound is both projected directly at you and reflected off your walls, to

heighten the live stereo effect. No matter where you place the Quadrant speakers, your entire listening area becomes a giant stereo sound chamber. Go anywhere in the room... even sit on a speaker... you're surrounded by rich, full-range stereo sound!

Unbelievable? Hear the Quadrant's wall-to-wall stereo, at your Scott dealer's. You'll become a believer. \$149.95.

For more details, write:

SCOTT
H.H. Scott, Inc., Dept. 160-01, Maynard, Mass. 01754

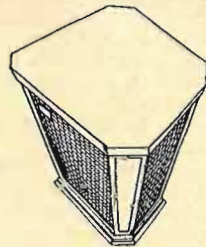

signaling device: bell, siren, or house lights. It communicates to police by direct line or automatic dialer and gives early warning of forced entry through roof, wall, door, or windows.

The master control contains four input channels. Each monitors one radar antenna, a single circuit of up to five stress sensors, or an almost limitless number of perimeter contacts. Gain on each channel can be varied to adjust range and sensitivity. A standby Nicad battery provides protection in case of power failure. Electronic Detection

Circle No. 20 on Reader Service Card

METAL DETECTOR

A heterodyne-type metal locator is now available in kit form as the Model MD-90 "Treasure Seeker."

The solid-state unit is housed in a rugged steel case on a two-piece aluminum handle. The pick-up head is molded of high-impact plastic. It has a rubber hand grip and adjustable angle brackets for personal preferences. The kit is complete and comes with all components, wire, and solder. All mechanical parts are precut, drilled, and finished. A PC board and comprehensive instruction manual make it easy for even a beginner to assemble the unit, according to the company. Kits Industries

Circle No. 21 on Reader Service Card

MULTIMETER

The Model 61 multimeter features 50,000 ohms/volt sensitivity, full electronic protection of the 17- μ A movement against overloads up to 1000 times in either direction, fuse protection of input circuits, and accurate response to frequencies up to 100,000 Hz.

Ranges starting at 250 mV d.c. and 25 μ A d.c. can measure as low as 5 mV and 0.5 μ A. A.c. voltage ranges are 0-2.5, 5, 10, 50, 250, 1000 and current ranges are 0-10 A.

This 1.5 pound unit comes in a leather carry-

ing case with tilting handle. It measures 5 $\frac{3}{16}$ " x 4 $\frac{1}{8}$ " x 1 $\frac{7}{8}$ ". Leads are included. SEP Instruments

Circle No. 22 on Reader Service Card

IC BREADBOARD

A convenient breadboard for the design engineer working with circuits involving IC's and/

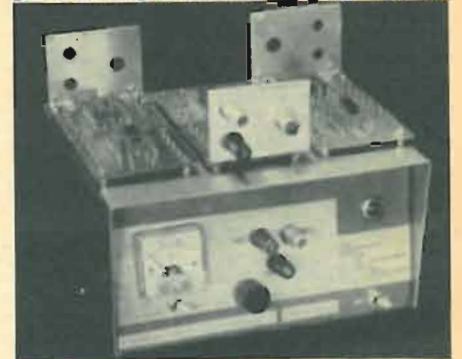

or discrete components is now on the market as the ICB II.

According to the company, the new unit makes it easy to evaluate new IC performance, saves engineering time, speeds final circuit design, and serves as a tester for small incoming shipments of IC's. It is also suitable as a teaching aid for electronics courses.

The standard 117-volt model includes six single IC boards and three miscellaneous brackets for holding BNC connectors and potentiometers. Additional IC boards are available as are a number of options. Full details on request. Berkeley Electronics

Circle No. 23 on Reader Service Card

4-BAND BC/SW RECEIVER

The Model SX-133 receiver is a four-band, (535-1610 kHz, 1.725-4.7 MHz, 4.5-13.0 MHz, and 11.9-31.5 MHz), AM-c.w.-SSB unit covering all amateur bands from 80 to 10 meters, international short-wave, marine, and other short-wave broadcasts, as well as standard AM bands.

Features switchable automatic noise limiter; crystal filter for added selectivity; provisions for optional 100-kHz crystal oscillator; built-in vari-



able b.f.o. and product detector for clear reception of code and SSB; and r.f. and a.f. gain controls. Receiver has universal phone jack, "S" meter, and illuminated slide-rule dial with colored-coded reference to main tuning dial.

Operates from 117-V, 50/60 Hz source and measures 18 $\frac{7}{8}$ " w x 8" h x 9 $\frac{3}{4}$ " d. Requires separate speaker. Hallicrafters

Circle No. 24 on Reader Service Card

HELIUM-NEON LASERS

Low-cost helium-neon lasers that emit highly collimated light suitable for optical laboratory demonstrations and experimentation are being offered by Metrologic Instruments Inc., 144 Harding Ave., Bellmawr, N.J. Both sealed-optic Models 205 (see figure) and 210, with outputs of 0.3 and 0.7 mW and beam divergences of 1.5 and 0.8 mrad, respectively, and a variable optic



type, Model 220, that can be used to obtain lasing at 1.15 and 3.38 microns or other helium-neon lines are available.

All models are supplied with coated optics for operating at the bright red 633-nm wavelength and without power supplies or other hardware. These laser tubes and optics are designed for those who want bare lasers without the power supplies or other hardware.

Circle No. 25 on Reader Service Card

MANUFACTURERS' LITERATURE

CONNECTOR SELECTOR

A handy connector selector slide-rule that catalogues a complete line of "Min-Rac" connectors is now available from Amphenol Industrial Division, 1830 South 54th St Avenue, Chicago, Illinois 60650.

The user places the arrow in the horizontal window of one of six family types (fixed contact, high density, encapsulated contact, hard dielectric, "Poke-Home," or power/coax) and then reads pin-and-socket connector characteristics by arrow in the vertical window. Characteristics included are temperature range, insulator material, contact size, wire sizes accepted, electrical specs, and shell material platings. The slide-rule can then be turned over and the corresponding part number read out directly for ordering purposes.

Write on your business letterhead for a copy of this handy rule.

REED SWITCHES

Hamlin Inc., Lake & Grove Streets, Lake Mills, Wisconsin 53551 has issued a condensed catalogue which offers a load selection guide for the many standard types of reed switches in the company's line.

Ranging from microminiature switches with a glass length as small as 0.375 inch and a diameter of 0.090 inch to standard size and mercury wetted types, the line is detailed in easy-to-read

charts which show contact arrangement, dimensions, switching voltage, and other electrical characteristics for almost 40 switch types.

A letterhead request to the company at the above address will bring a copy of the catalogue.

INSTRUMENTS FOR RENT

Electro Rents, 4131 Vanowen Place, Burbank, California 91504 has issued a new electronic instrument rental catalogue featuring HP 9100A programmable electronic calculator, HP 8553L/8552A spectrum analyzer, Tektronix 323 portable oscilloscope, Systron Donner 7015 u.h.f. frequency counter, Dynamic 7514 differential d.c. amplifiers, and a complete line of laboratory power supplies from Lambda.

For a copy of this catalogue, write on your business letterhead to the company at the above address, attention of Dude Richardson, Vice-President, Marketing.

APPLICATION NOTES

Three "application notes" have been published by the Semiconductor Division of Westinghouse Electric Corporation, P.O. Box 868, Pittsburgh, Pa. 15230.

The first booklet (AD-54-580-B) is an 8-page application note entitled "Thyristor Design Trade-Offs in Turnoff Specifications." Emphasis is on motor controls, inverters, and allied applications. A second 4-page note discusses the alternative to the conventional d.c. linear series voltage regulators in systems requiring high efficiency and is entitled "Type 1763 Transistor Chopper" (AD-54-680-B), while the third is called "Selecting Your Thyristor Gate Drive" (AD-54-581-B).

Any or all of these publications are available upon letterhead request.

SOLID-STATE PRODUCT GUIDES

RCA Electronic Components, Harrison, N.J. 07029 has published two handy guides: "SK-Series Top-of-the-Line Replacement Guide" (SPG-202H, 20 cents) and "Quick Reference

Guide for RCA Solid-State Devices" (SPG-201F, 35 cents).

The first booklet (40 pages) lists in numerical-alphabetical sequence more than 12,000 domestic and foreign semiconductor devices used in entertainment equipment and the recommended SK-Series replacement transistor, silicon rectifier, or IC.

The second booklet (48 pages) gives specific data on more than 1000 solid-state devices: IC's, transistors, thyristors, silicon rectifiers, tunnel diodes, diodes, and optical products. A special format permits quick selection of a device by a type number, function, or application.

For either or both of these publications send your order direct to the company with payment in full for the booklets wanted.

AUDIO ACCESSORIES

Catalogue #116 is a new 8-page brochure covering an extensive line of audio accessories ranging from cables for hi-fi and cassette tape recorders and players and extensions for American and European equipment, to various adapters, plugs and sockets, and microphones for use with cassette tape recorders and players.

Each item in the line is pictured and described with details on its application. Workman

Circle No. 26 on Reader Service Card

EXPERIMENTER'S KITS

A handy brochure describing the company's line of Experimenter's Kits for hobbyists, hams, technicians, and educators is now available. Each kit is described in some detail and related experimenter's manuals are discussed. RCA Electronic Components

Circle No. 27 on Reader Service Card

TTL IC CATALOGUE

Texas Instruments Incorporated has issued a new 424-page catalogue (CC 201) on its TTL integrated circuits. The publication includes data sheets on every circuit in the firm's three series

DON'T MAKE A SOUND

WITHOUT THE POWERLINE FROM UNIVERSITY

The industry's first and only solid state, transistorized, computerized public address amplifiers with high fidelity performance.

Built from the ground up to take full advantage of space-age circuitry, with features you won't find in any other line at any price.

Dependable? Any amp in the Power-Line series can go from no load to full load, even a complete short circuit, without blowing an output transistor! (Or anything else, including your stack.) Why? Because of University's exclusive automatic computer logic cir-



cuit. Direct coupling for cleanest sound, greatest efficiency, lowest distortion.

High fidelity performance? You bet! You can use the Power-Line not only for public address applications but it's also great for quality background music reproduction.

16 Models to choose from: eight deluxe and eight standard with or WITHOUT OUTPUT TRANSFORMERS (and if your system's size will let you use the transformerless models, University just saved you a bundle of time and money), with 20, 35, 60, or 100 watts of clean, proven performance.

For more details, write for our new catalogue and the name of your nearest University dealer.



UNIVERSITY[®] SOUND

A DIVISION OF LTV LING ALTEC, INC.
P.O. Box 26105 Oklahoma City, Okla. 73126

CIRCLE NO. 103, 98 ON READER SERVICE CARD

LAFAYETTE
RADIO ELECTRONICS

FREE!

1970 CATALOG NO. 700
JUST OFF THE PRESS!!
SEND FOR YOUR EXCITING COPY NOW!



YOUR 1st GUIDE TO
EVERYTHING IN
ELECTRONICS

- * CITIZENS BAND 2-WAY RADIO
- * STEREO/Hi-FI COMPONENTS
- * MUSICAL INSTRUMENTS AND AMPLIFIERS
- * PUBLIC ADDRESS
- * AMATEUR RADIO
- * TEST EQUIPMENT
- * PARTS

**LATEST
RELEASES!
BEST
BARGAINS!
496
Pages**

- * PORTABLE AND TABLE RADIOS
- * PHOTO EQUIPMENT
- * TOOLS BOOKS
- * AUTO ACCESSORIES
- * EDUCATIONAL AND OPTICAL
- * TV AND ANTENNAS

Mail the Coupon Today
for your FREE 1970
Lafayette Catalog 700

LAFAYETTE Radio ELECTRONICS
Dept. 01010, P.O. Box 10
Syosset, L.I., N.Y. 11791

Please Send the FREE 1970 CATALOG 700 01010

Name

Address

City State

Zip
(please include your Zip Code No.)

CIRCLE NO. 124 ON READER SERVICE CARD

GET INTO **ELECTRONICS**



V.T.I. training leads to success as technicians, field engineers, specialists in communications, guided missiles, computers, radar and automation. Basic & advanced courses in theory & laboratory. Electronic Engineering Technology and Electronic Technology curricula both available. Assoc. degree in 29 mos. B. S. also obtainable. G.I. approved. Graduates in all branches of electronics with major companies. Start September. February. Dorms. campus. High school graduate or equivalent. Write for catalog.

VALPARAISO TECHNICAL INSTITUTE
Dept. RD, Valparaiso, Indiana 46383

and covers more than 90 distinct functions in the line, including 35 medium-scale integration circuits. The MSI functions listed are data selectors/multiplexers, decoders, memories/latches, shift registers, counters, parity generators/checkers, and arithmetic elements.

Other integrated circuit series available from the company are also listed.

Write on your business letterhead to Inquiry Answering Service, P.O. Box 5012-M/S 308, Dallas, Texas 75222 and specify "TTL Catalogue."

CERAMIC FILTERS

A new two-page, two-color technical bulletin describing the company's TCF hybrid ceramic filters has been issued by Cleveite Corporation's Piezoelectric Division, 232 Forbes Road, Bedford, Ohio 44146.

The TCF-4 and TCF-6 filters are computer designed for modern two-way communications sets. They combine a ladder network of ceramic resonators with a tuned transformer to give a d.c. path at input. Features include high selectivity/cost ratio, exceptional stability, fine-tuned d.c. input, and a wide choice of bandwidths, according to the company.

Write on your business letterhead direct to the company for a copy of this brochure.

POWDER-CORE GUIDE

A new 76-page catalogue and designer's guide covering Moly Permalloy powder cores has been published by The Arnold Engineering Company, P.O. Box "G", Marengo, Illinois 60152.

This handbook provides MPP core data in a highly usable format and contains all of the technical information that a design engineer needs. It also includes tables which state the physical and electrical specifications for 25 standard-sized cores and "Q" curves showing the permeability available for each size core.

A section on "Formulas and Mathematics of Magnetics" is designed to help the engineer optimize the selection of the best MPP core for his needs.

A letterhead request to the company will bring a copy of this publication. Please specify Catalogue PC-104D.

NEW PRODUCT CATALOGUE

Lambda Electronics Corp., 515 Broad Hollow Road, Melville, N.Y. 11746 has published a 16-page catalogue describing four new lines of power components, power instruments, and power systems.

Described is a miniature size, low-cost laboratory d.c. power supply, the first bench-type supply to use an integrated circuit to provide the

regulation system. Several new package sizes have also been added to the d.c. modular power supply line and 27 new models of a.c. power conditioners are included.

Complete performance specs, price information, and ordering data are supplied. Write on your business letterhead for a copy.

PC COATING SELECTOR

The Hysol Division of The Dexter Corporation, Franklin Street, Olean, N.Y. 14760 has just issued a new selector guide for printed-circuit coatings. This easy-to-use guide lists the major characteristics of eight different PC coatings, five urethane and three epoxy. Four of the coatings are available in military versions to meet the requirements of MIL-I-46058B.

Differences between various coatings, such as film thickness, pot life, shock resistance, and other features are presented in easy reference form.

When writing on your business letterhead, please specify Form E4-100.

READOUT CATALOGUE

An 8-page catalogue which lists and illustrates a line of miniature readout indicators and the decoder-drivers required for particular models has been published by Alco Electronic Products, Inc., P.O. Box 1348, Lawrence, Mass. 01842.

The "Elfin" neon readout indicators have detailed specs, code tables, dimensional drawings, and prices. Other series listed include incandescent types in the metal encased MS-400 series and the MS series single-plane mosaic readouts.

Address your letterhead request to Robert E. Laffey, sales manager, at the above address.

RELAY CATALOGUE

A new 20-page Distributor Stock Catalogue, providing technical data on more than 500 electro-mechanical relays and opto-electronic components, plus selective price changes, is now available from Sigma Instruments Inc., 170 Pearl Street, Braintree, Mass. 02185.

All products are illustrated, dimensioned, and described. A relay selection guide cross-references desired performance features to specific relays, and includes engineering considerations in relay selection.

Write on your business letterhead for a copy of this catalogue.

CAPACITOR LINE

Cornell-Dubilier Electronics, 50 Paris Street, Newark, New Jersey 07101 has issued a four-page illustrated brochure containing information on a new wide-range line of tubular aluminum electrolytics introduced by the firm.

MAGNETIC RECORDING INDUSTRY Estimated Worldwide Sales for 1969 Courtesy of Ampex Corp.

1. Computer:	Tape transports	\$1,935,000,000
2. Audio:	Recorder/reproducers for broadcasting, mastering, duplication, industrial use, home entertainment, cassettes and cartridges, microphones, accessories and speakers	841,000,000
3. Magnetic tape:	For all applications—audio, video, computer, instrumentation, pre-recorded stereo	305,000,000
4. Video:	Broadcast and closed-circuit videotape recorders, receivers and systems	182,000,000
5. Instrumentation:	Recorders and systems for laboratory and mobile use	65,000,000
6. Videofile:	Information Systems	Unknown
Total:		\$3,328,000,000

The new capacitor line, Type WBR, is wide-range rated, giving complete capacitor coverage with only 72 different units. Capacitance values from 1 to 10,000 μ F with voltage ratings from 10 to 500 volts are included in the line.

Complete details on the available units are included in the brochure, which will be forwarded on letterhead request.

ANTENNA ROTATORS

A four-page, four-color brochure illustrating a heavy-duty antenna rotator and two companion control units is now available. A cross-sectional view of the rotator with its special features called out is also included. RCA

Circle No. 28 on Reader Service Card

ELECTRONICS TOOLS

A new 24-page catalogue (No. 200A) listing an extensive line of precision tools for electronics, telecommunications, and industry applications is ready for distribution.

Over 500 various spring adjusters, gages, burnishers, and miscellaneous hand tools are illustrated in detailed drawings with dimensions and specifications. Tools are grouped in 13 classifications and are listed in numerical sequence. The catalogue also contains a convenient meters-to-inches conversion chart. Jonard

Circle No. 29 on Reader Service Card

CHEMICALS FOR SERVICING

A new catalogue of chemical products designed specifically for the electronic service industry is available as No. 6970.

The 8-page publication covers tuner sprays, contact and control cleaners, insulating sprays, lubricants, circuit coolers, and a variety of other servicing aids. Chemtronics

Circle No. 30 on Reader Service Card

LAMPS & READOUTS

A 16-page catalogue describing a full line of micro-miniature digital display readouts, micro-decoder/driver modules, and incandescent lamps is now available from Pinlites Inc., 1275 Bloomfield Avenue, Fairfield, N.J. 07006.

Included in Catalogue 1969-2 are complete technical data, graphs and diagrams showing light/life voltage relationships, life-expectancy data, response times, and mounting designs.

A letterhead request to the company will bring you a copy.

ELECTRONIC INSTRUMENT RENTALS

Rentronix, a division of Inmark, Inc., 11501 Huff Court, Kensington, Maryland 20795 has issued a complete 48-page catalogue covering a wide variety of electronic equipment available for short-term rentals.

The equipment includes oscilloscopes, counters, recorders, signal generators, digital voltmeters, power supplies, and many other types of general-purpose test equipment, as well as small computers and computer peripheral equipment.

Write on your business letterhead for a copy of the catalogue. ▲



"What's so great about getting your own key to the men's room after five years? I got one on my first day on the job!"

BESTSELLING SAMS BOOKS

for every electronics interest

1-2-3-4 Servicing Automobile Stereo

The "1-2-3-4 Method" is a simple, logical step-by-step process which helps do the servicing job in the easy way and the right way. This book first applies the Method to both mechanical and electrical equipment, and then proceeds to cover the electronic and mechanical principles of automobile stereo, fm multiplex, and tape cartridge systems. Finally, the book shows how to apply the "1-2-3-4 Method" to auto stereo systems. Includes a wealth of schematics, charts, and illustrations. Order 20737, only.....\$3.95

Closed-Circuit Television Handbook, 2nd Ed.

Explains in practical terms the basic concepts of CCTV systems. Describes the versatile applications of closed-circuit television, and the equipment used. Subjects include cameras, monitors, video recorders, lighting, and signal transmission. Completely updated to include latest information. Order 20726, only.....\$5.95

Antennas and Transmission Lines

A readily understandable text and reference on the theory of antennas and transmission lines, using technician-level mathematics. The book opens with basic antenna theory, including point and array sources, wave interference, standing waves, collimators, lenses, apertures, and simple radiators. It then proceeds to transmission lines and their design factors. The final third of the text covers a broad variety of antenna topics. An ideal book for home study and reference. Order 20716, only.....\$7.95

Record Changer Servicing Guide

This book provides a complete understanding of record changers, how they operate, and the various systems employed. Provides detailed instructions on how to track down troubles encountered in record changers and how to repair them in the fastest and most effective way. Order 20730, only.....\$3.95

Auto Radio Servicing Made Easy, 2nd Ed.

Explains the circuitry of both new and old auto radios, covering each of the tube and transistor stages. Provides step-by-step troubleshooting and repair details; explains how to eliminate noise and interference, how to set the bias on output transistor stage without breaking circuit, how to determine correct bias on transistor stages, what to do about AVC trouble in transistor radios, etc. Order 20719, only.....\$3.95

ALL-NEW EDITION OF THE FAMOUS Audio Cyclopedia

Completely revised 2nd Edition by the renowned authority, Dr. Howard M. Tremaine. This is the most comprehensive work on audio—virtually a complete reference library in a single volume. Fully covers every phase of the subject, including all the latest developments, right down to the newest solid-state and integrated circuits. Contains authoritative, concise explanations of thousands of topics in the fields of acoustics, recording, and reproduction; covers basic principles, components and devices, film recording, studio techniques, motion picture equipment, audio installation techniques, audio measurements, etc. Each subject is located instantly through a unique chapter and paragraph numbering system. Supported by over 1600 illustrations. This is truly the master reference work on the audio art. Order 20675, only.....\$29.95

NEW 5TH EDITION OF THE WORLD-FAMOUS Reference Data for Radio Engineers

Now contains 50% more data to cover the developments of the past 12 years. Prepared by outstanding engineers, professors, and experts, under the direction of the International Telephone and Telegraph Corporation staff. Provides comprehensive data on all basic phases of electronics, including tables, formulas, standards, and circuit information—PLUS—all-new data on micro-miniature electronics, navigation aids, reliability and life testing, international telecommunication recommendations, switching networks and traffic concepts, and quantum electronics. Over 1350 illustrations 1196 pages. Order 20678, only.....\$20.00

Amateur Tests and Measurements

This new E & E book shows how to perform virtually all tests on amateur transmitters, receivers, and antennas, and how to make required adjustments. An invaluable book for the amateur who wants to maintain top operating efficiency. Order 65072, only.....\$5.50

101 Questions & Answers About Amateur Radio

A handy and practical reference source providing the answers to the most frequently asked questions about ham radio. An invaluable book for both the newcomer and the old-timer. Order 20731, only.....\$2.95

Transistor Specifications Manual, 3rd Ed.

Updated to include the latest 1969 transistors. Contains the electrical and physical parameters for virtually all of the transistors now in use. Electrical parameters include maximum collector-to-base, emitter-to-base, and collector-to-emitter voltages; maximum collector current; power dissipation; and maximum operating temperature. Also lists frequency gain and leakage parameters. Order 20707, only.....\$4.25

Fundamentals of Digital Computers

An excellent introductory text to the general field of electronic computing. It enables anyone to acquire a good basic understanding of what computers do and how they do it. The book begins with a discussion of various types of computer applications and surveys the history and evolution of computers. Then, it discusses in detail subjects such as the functional organization of a computer, the individual components of a computer system, data preparation, storage devices, input and output peripheral devices, conversion units, and the central processor. A comprehensive glossary of computer terms is included. Order 20714, only.....\$5.50

SPACE AGE TECHNOLOGY SERIES

Prepared under the guidance of *Training and Retraining, Inc.*, this series of five books holds unusual interest for anyone who desires to learn about the application of electronics to space progress, and the vital role it plays in that technology. All texts are programmed-type.

- Inertial Guidance Systems. Order 20605, only.....\$4.95
- Controlled Guidance Systems. Order 20573, only.....\$4.95
- Synchros and Servos. Order 20533, only.....\$4.95
- Lasers and Masers. Order 20559, only.....\$4.95
- Microminiature Electronics. Order 20582, only.....\$5.75

SPECIAL OFFER! All 5 Volumes at a savings, in beautiful slip case. Order 20724, only.\$24.95

HOWARD W. SAMS & CO., INC.

Order from any Electronic Parts Distributor, or mail to Howard W. Sams & Co., Inc., Dept. EW-1 4300 W. 62nd St., Indianapolis, Ind. 46268

Send books checked at right. \$_____ enclosed.
 Send FREE 1970 Sams Book Catalog

Name _____
PLEASE PRINT

Address _____

City _____ State _____ Zip _____

- | | |
|--------------------------------|--------------------------------|
| <input type="checkbox"/> 20737 | <input type="checkbox"/> 20707 |
| <input type="checkbox"/> 20726 | <input type="checkbox"/> 20714 |
| <input type="checkbox"/> 20716 | <input type="checkbox"/> 20605 |
| <input type="checkbox"/> 20730 | <input type="checkbox"/> 20573 |
| <input type="checkbox"/> 20719 | <input type="checkbox"/> 20533 |
| <input type="checkbox"/> 20675 | <input type="checkbox"/> 20559 |
| <input type="checkbox"/> 20678 | <input type="checkbox"/> 20582 |
| <input type="checkbox"/> 65072 | <input type="checkbox"/> 20724 |
| <input type="checkbox"/> 20731 | |

CIRCLE NO. 115 ON READER SERVICE CARD

1969 INDEX

VOLUMES

81-82

As a service to our readers we are presenting this complete listing of all feature articles which appeared in **ELECTRONICS WORLD** during 1969. We suggest you keep this for reference.

COMMUNICATIONS

Bandwidth Compression for Efficient Digital Communications (Stumpe)	Mar.	49
BART: Electronics Aids Rapid Transit (Wujek, Jr.)	Jan.	36
Commercial TV Helps NBS's Standards Broadcasts	June	65
Communications on the Moon	Aug.	23
Communications Satellites—Success in Space (Part 1) (Gicca)	July	23
Communications Satellites—Success in Space (Part 2) (Gicca)	Aug.	44
Communications System Aids Ohio Police in War on Crime	June	53
FCC Proposed Rule Making for 2-3 MHz Marine Band (Humphrey)	Feb.	71
GM Research Labs New Sponsor of REACT	June	66
High-Speed Telemetry Moves to U. H. F. Apr. Ionospheric-Propagation Predictions (Wood)	Apr.	27
Low-Noise Receiver Performance Measurements (Bishop)	Mar.	38
Mariner Spacecraft: Explorers of Mars (Holder)	Sept.	43
Omega: A V.L.F. Radionavigation System (Lacy)	Dec.	47
Operation Survival (Foss & Mayo)	Aug.	41
Protection System for Solid-State Transmitters (Smith)	Feb.	38
Radio Mirrors for Communications (Thrauer)	May	27

COMPONENTS

Active Filters (Hogin)	Apr.	58
Beads Block Noise	Apr.	55
Breadboard Circuits from PC Boards (Firth)	Oct.	65
Ceramic Filters (Zimmerman)	Apr.	53
Computer-Designed PC Boards (Bauer)	Oct.	47
Conformal Coatings for Printed Circuits (Leibmann)	Oct.	50
Connectors for PC Boards (Hecker & Novak)	Oct.	52
Crystal Filters (Kent)	Apr.	50
Dry Process for Making PC Boards	Oct.	55
Filters for Microwaves (Felsenfeld, Jr.)	Apr.	45
Flexible Printed Wiring (Vigliani)	Oct.	58
High-Density PC Boards (Roffmann, Jr.)	Oct.	42
Hal-Carrier Diodes (Adam)	July	46
Importance of Filters (Seidman)	Apr.	37
LC Filters (Rosenfield)	Apr.	40
Light-Emitting Diodes (Myers & O'Brien)	July	41
Light-Sensitive Photodiodes	July	45
Mechanical Filters (Southworth)	Apr.	56
Microwave Power Diodes (Nblack & Levi)	July	49
New Coax Connector Tops Performance Records (Pessah)	Aug.	28
Power FET (Tamosaitis)	June	34
Practical Operating Limits for Filters	Apr.	44
Printed-Circuit Kits for Short Runs (Steinbach)	Oct.	56
Printed-Circuit Laminates (Skaw)	Oct.	44
Printed-Circuit Technology (DiNuzza)	Oct.	37
R. F. Interference Filters (Rosen)	Apr.	48
Rotary Thumbwheel Switches for Digital Applications (Squires)	May	40
Solid-State Inductor (Heiserman)	Sept.	37
Survey of Silicon Junction Diodes (Seidman)	July	35
Tunnel Diodes	July	53
Using Transistors as Negative-Resistance Devices (Vincent)	June	38
Variable-Capacitance Diodes (Carroll)	July	38

HIGH FIDELITY & AUDIO

Audio Equalization Curves Up-to-Date (Haskett)	Dec.	44
Cassette Tape Recorders—A New Breed (Kubiak)	June	23
Closed-Box Speaker Systems (Morgan)	Nov.	36
Dolby Noise-Reduction System—Its Impact on Recording (Eargle)	May	32
Electronic Piano (Lacy)	Nov.	40
EW Lab Tests of New Cassette Tape Recorders (Hirsch)	June	26
EW Lab Tests Stereo Compacts (Hirsch)	Dec.	27
Four-Channel Stereo (Editorial)	Dec.	6
Hi-Fi Power-Rating Problems	May	6
Hi-Fi Show Seminars Program	Oct.	66
High-Gain Audio Amplifier Input Stage (Tooker)	July	77
How to Add Remote Speakers to Hi-Fi Stereo Systems (Brociner)	Jan.	31
Loudspeakers—Can We Measure What We Hear? (Brociner)	Mar.	25
Which P.A. Speaker Should You Use? (Part 3) (Cohen)	Dec.	50
Multichannel Recording for Creating the "New Sound" (Wickersham)	Sept.	38
Multiplexing Audio Entertainment for the Boeing Superjet (Partridge)	Sept.	40
New Approach to Color-Organ Design (Pawell)	Jan.	39
New Developments in Public-Address Systems (Part 1) (Zuckerman)	Sept.	32
New Color-Organ Kit	May	80
New Concepts in Hi-Fi Receiver Design (Fish, Jr. & Peter)	Feb.	32
Sales of Pre-Recorded Tapes Soar	Oct.	68
Selecting a Tape Recorder (Kubiak)	May	39
Speaker-Matching Problems in P.A. Systems (Part 2) (Cohen)	Oct.	32
Stereo versus the Concert Hall (Harman & MacLean)	Apr.	34
Tape-Recorder Wow & Flutter (Hawk)	June	36
Truth about FM (Haskett)	Aug.	37
EW LAB TESTED		
Acoustic Research AR-3a Speaker System	Jan.	22
Allied TR-1080 Stereo Tape Recorder	Apr.	22
Ampex AG-600-2 Tape Deck	Mar.	22
Ampex 715 Speaker System	Dec.	12
Ampex 1461 Tape Recorder	Sept.	16
Dual 1212 Automatic Turntable	Nov.	17
Dynaco A-25 Speaker System	Oct.	22
Eica Model 3150 Stereo Amplifier	Sept.	16
Garrard SL 95 Automatic Turntable	July	20
Hallcrafters CR-3000 Receiver	Aug.	12
Harman-Kardon HK50 Speaker System	Nov.	17
Jensen TF-25 Speaker System	Apr.	22
Kenwood KA-6000 Stereo Amplifier	Mar.	22
J. B. Lansing SE400S Stereo Power Amplifier	Feb.	22
Miracord 620/630 Automatic Turntables	Aug.	12
Scott LR-88 AM/FM Stereo Receiver	May	17
Shure M92E/M93E Phono Cartridges	Oct.	22
Sony TA-2000 Stereo Preamplifier	May	17
Tannoy "Manitor Gold" Speaker System	July	20
Teac A-6010 Tape Deck/Preamp	Feb.	22
Thorens TD-125 Turntable	Dec.	12
Viking 433 Tape Deck/Preamp	Jan.	22

INDUSTRIAL & GENERAL

Atomic Radiation: Types & Relationships (Part 1) (Wujek, Jr.)	May	46
Atomic Radiation: Detection Methods (Part 2) (Wujek, Jr.)	June	46

Atomic Radiation: Measuring Techniques (Part 3) (Wujek, Jr.)	July	28
Automating the Railroads (Selby)	Feb.	46
Biomedical Engineers Stress Need for Rapport with MD's	Apr.	72
Certification for Engineering Technicians (Frenzel, Jr.)	Jan.	83
Choosing a Digital Display (Bell)	Feb.	25
Control of R. F. Interference (Hawk)	Dec.	41
Electrohydraulic Effect (Lawrence)	May	44
Electric Shock (Frye)	Aug.	50
Electronics and the Living Plant (Lawrence)	Oct.	25
Electronics & Psychology (Frye)	May	60
Electronics in Weighing Systems (Math)	Nov.	46
Electronics of Corrosion (Ferren)	Nov.	42
Electronic Speed Control for the '69 Ford (Holder)	May	35
Electronic Type Composition (Lacy)	Dec.	34
Experimental Laser Engines (Lawrence)	June	30
Geomagnetic Observatories (Lawrence)	Feb.	41
High-"Q" Inductive Electronic Ignition System (Keroes)	July	32
IC Frequency Dividers & Counters (Part 2) (Steinbach)	Jan.	49
Infrared Locates Diseased Trees (Neubert)	Aug.	34
Japanese Trade-Name Directory	Aug.	75
Keeping Abreast of Your Field (Frye)	Apr.	62
Medical Electronics Servicing (Frye)	Oct.	63
Metal Boxes Built to Size (Brack)	Mar.	84
Multiple-Function Remote-Control Relay Circuits (Mallory)	Aug.	36
Natural Interfaces	Apr.	65
Paleomagnetism & Archeomagnetism (Lancaster)	Sept.	23
Piezoelectric Igniter Generates Instant Flames (Markeson)	Nov.	72
Reading Aid for the Blind (Brugler & Young)	Nov.	48
Redistribution of Computer Market is Forecast	May	63
Resistivity: Some Definitions (Tusinski)	Nov.	86
Safety in Medical Electronics (Frye)	July	58
Some "Technical Terms" Aren't (Stern)	June	21
Spirit of Leonarda (Frye)	Mar.	54
"Standards" Index Set up at NBS	Apr.	73
Stop-Action Photos (Lowe)	Mar.	47
Strain Gages Come of Age (Tusinski)	Mar.	35
Thermoluminescence—Theory & Applications (Lancaster)	Mar.	43
Ultrasonic Waves Made Visible (Snitzer)	May	51
Unique Capacitor-Discharge Ignition System (Marris & Marton)	Jan.	45
Variable-Rate Windshield Wiper (Mentler)	Oct.	76
Voltage Regulator for Enlarger Lamp (Wolff)	Sept.	74
Will There Be—An Electronic Mail Service? (Buchsbaum)	Aug.	30

NOMOGRAMS & DESIGN CHARTS

Color Code Charts	Oct.	29
Decibel Table	Sept.	27
Decibels without Logs (Miller)	Sept.	71
Link Coupling Nomogram (Moffat)	Jan.	40
Reactance Chart	Nov.	31

TELEVISION & RADIO

Automatic Tint Control for Color-TV (Snitzer)	Sept.	30
Brighter Picture Tubes for Color-TV (Snitzer)	Aug.	33
Color-TV for 1969 (Bell)	Jan.	25
Cost of Color-TV Service (Frye)	Feb.	56
Color-TV Tape Player Uses Laser and Holograms (Snitzer)	Dec.	31
Customer Revolt (Frye)	Nov.	56
Designing a Receiver for Cable TV (Frye)	June	50
Directory of Most Popular, Low-Priced Video Tape Recorders	Nov.	32
Fix It or Junk It? (Frye)	Sept.	56
How to Be a Good Service Customer (Frye)	Jan.	57
Installing a Home Master Antenna TV System (Sarajiotis)	June	41

Motorola's Non-Mechanical Remote Control	Jan.	60
New TV Front-Ends (Bell)	Sept.	47
1969 Color-TV Chassis	Jan.	26
Plea for A United Service Association (Woodbury)	Nov.	13
Technicians' Chance to Gripe (Frye)	Dec.	56
TV Channel Assignments	Nov.	66
TV Chroma Circuit Alignment (Bell)	Feb.	48
TV Servicing (Editorial)	Nov.	6
TV Systems for Teacher Education (Lawrence)	Jan.	42
Transistor Trends in Color-TV	Jan.	67
Using Controls to Troubleshoot TV (Matsuda)	Mar.	32

TEST EQUIPMENT & MEASUREMENTS

A.C. Line Voltage Monitor (Geilker)	Jan.	85
Capacitance Probes in Industrial Instrumentation (Shiver)	May	42
Cost of Color-TV Service (Frye)	Feb.	56
Design of a Light Meter & Exposure Calculator (Barnum)	May	52
Digital IC Timer (Steinbach)	May	48
Distributed Plates Improve CRT Response (Pettis)	Nov.	28
Dual-Rate Sawtooth Generator (Tooker)	May	74
Dual UJT Multivibrator (Tooker)	Feb.	45
Electronic Loadbank—Tests Power Supplies Dynamically (Bengner)	June	44
Electrolytic-Capacitor Tester (Fleshren)	Oct.	82
FET Sine-Wave Crystal Oscillators (Tooker)	June	33
50-MHz Digital Counter (Cody)	Mar.	40
High-Efficiency D.C.-D.C. Converter (Levy & Blair)	Feb.	35
IC Sine-Wave Clipper (Tooker)	Nov.	96
Improving Sawtooth Linearity	Feb.	84
Low-Cost D.C.-Voltage Calibrator (Gorner)	Sept.	42
Low-Cost Precision Scope & V.T.V.M. Calibrator (Lehmann)	Mar.	80
Neons in Photoconductive Choppers (Tolbot)	Apr.	32
Oscilloscope Evolution (Griffin)	Nov.	25
Oscilloscope Kits (Robertson)	Nov.	26
Radiation Detector Sounds Off (Walters)	Aug.	76
Recording Oscilloscope (Seidman)	Nov.	27
Repetitive Ramp Generator (Burns)	Oct.	87
SCS Crystal-Controlled Oscillator (Tooker)	Oct.	74
Save with a Single-Turn Pot (Caso)	Apr.	92
Simple Frequency Counter (Carroll)	July	82
Split Probe Measures Current (Brock)	Jan.	82
Sub-Ohm Continuity Tester (Todd)	Feb.	78
Series-Pass Regulators (Fay)	Mar.	48
Tri-Color Oscilloscope	Nov.	30
Triggered Sweep for Any Scope (Gorgenyi)	Nov.	76
UJT Monocycle Multivibrator	Apr.	61
UJT Sine-Wave Generators (Tooker)	Feb.	82

PRODUCT REPORTS

AEI Instruments Model 101 IC Tester	May	67
B&K Model 415 Sweep/Marker Generator	Oct.	78
B&K Model HV-30 High-Voltage Tester	Jan.	76
Century General 140 Audio Tester	Feb.	66
Century General Model 4110 Audio Generator	Sept.	60
Data Instruments Model 550 Oscilloscope	Apr.	76
Delta Products Model 3000 FET V.O.M.	Mar.	68
Eico Model 385 Color-Bar Generator	Aug.	66
Eico Model 635 Tube Tester	Sept.	60
EMC Model 215 Tube and Transistor Tester	Apr.	76
Heath IG-28 Color-Bar Generator	Dec.	64
Heath Model IG-18 Sine, Square-Wave Audio Generator	June	59
Hewlett-Packard Model 204D Audio Oscillator	Oct.	78
Hickok Model CRO-5000 Oscilloscope	May	67
Holland Electronics Model TT-285 Transistor Tester	Nov.	70
Jackson Model CRO-4 Oscilloscope	Mar.	68
Leader Model LBO-53B Oscilloscope	Dec.	64

Leader LCG-388 & LCG-389 Color-Bar Generators	Feb.	66
Leader Model LTC-901 Transistor Tester	Oct.	78
Pulse Monitors Model 1210 Digital Test Probe	May	67
RCA Model WP-700A, 702A Power Supplies	Mar.	68
Seco Model HC-8 In-Circuit Current Checker	June	59
Sencore Model SM152 Sweep/Marker Generator	Aug.	66
Sencore Model TF17 Transistor Tester	Dec.	64
Sencore TF-151 Transistor Tester	Apr.	76
Simpson Model 229 A.C. Leakage-Current Tester	Nov.	70
Simpson Model 313 Solid-State V.O.M.	Jan.	76
Sperry Model Ohm-25 Snap-Around V.O.A.	Aug.	66
Sylvania CB2400 Tube Tester/Color-Bar Generator	June	59
Terado 50-150 A.C. Line Monitor-Regulator	Feb.	66
Triplet Model 310-FET V.O.M.	Sept.	60
Triplet Model 3444-A Tube Analyzer	Jan.	76
Vytell Model RP-1001 Resistor Box	Nov.	70

SOLID-STATE

Hot-Carrier Diodes (Adam)	July	46
Large-Scale Integration (Heiserman)	Dec.	37
Light-Emitting Diodes (Myers & O'Brien)	July	41
Light-Sensitive Photodiodes	July	45
Microwave Power Diodes (Niblock & Levi)	July	49
Solid-State Inductor (Heiserman)	Sept.	37
Solid-State LSA Microwave Diodes (Heiserman)	Feb.	40
Survey of Silicon Junction Diodes (Seidman)	July	35
Transistors Made of Glass (Seidman)	Feb.	68
Tunnel Diodes	July	53
Using Transistors as Negative-Resistance Devices (Vincent)	June	38
Variable-Capacitance Diodes (Carroll)	July	38



"Psst! The only thing wrong with the set is that Pop put the back on upside down."

PHOTO CREDITS

Page	Credit
26, 27	Sylvania
30 (top)	Cinch-Graphik
30 (center)	Northern Electric Labs.
30 (bottom)	Boeing
31 (top)	Airborne Instruments Lab.
31 (center)	Conn Electric Organs
31 (bottom left)	DuPont
31 (bottom right)	Motorola
34	Altec Lansing
39, 41	Argonne National Laboratory
44, 45	Ampex Corp.
67	Lockheed Electronics Co.

HOBBYISTS, EXPERIMENTERS, TECHNICIANS, INVENTORS, NOW YOU CAN HAVE YOUR BLACK AND WHITE TELEVISION CONVERTED TO COLOR, BY MEANS OF A NEW PATENTED CIRCUIT. COMPLETE INSTRUCTIONS AND BLUEPRINTS, WRITE, BELE ELECTRONICS CORP. 121 S.E. FIRST ST. MIAMI, FLORIDA.

COOPERATE WITH THE ZIP CODE PROGRAM OF THE POST OFFICE DEPARTMENT. USE ZIP CODE IN ALL ADDRESSES

STEREO TAPE TRANSPORT

Two speed, pause control, 7" reel, auto. tape lifters, record, playback, erase heads, service manual. No case.

Check or MO. FOR

STEREO CENTER
218 Columbia St.
Utica, N.Y. 13502

\$17.50

LATEST ARCTURUS SPECIALS

- Color focus rectifiers, 14,000 P.I.V. at 1 MA, 99¢ each. 6.5 KV-79¢.
- Color TV yokes 70° & 90° types. Fit almost all sets: \$10.95 each.
- 1700 Transistor types—39¢ each.
- DS-501, 2N278 power transistor types. Cat. #349, 69¢ each.
- HEP170, Motorola HV/Current epoxy silicon rectifiers, 2.5 amps at 1,000 PIV, 49¢ each.
- Fully transistorized UHF tuners. Fit most sets. Cat. #UHF567, \$4.95 each.
- UHF tuners, 1 tube type. Fit most sets. Cat. #UHF3, \$3.95 each.

Complete listings of electronic items at similar bargain prices are available. Write for our latest catalog. Minimum order \$5.00, plus postage.

ARCTURUS ELECTRONICS CORP.

502-22nd St., Union City, N.J. 07087 Dept. EW
Phone 201 - UN4 5568

ELECTRONICS MARKET PLACE

COMMERCIAL RATE: For firms or individuals offering commercial products or services. 85¢ per word (including name and address). Minimum order \$8.50. Payment must accompany copy except when ads are placed by accredited advertising agencies. Frequency discount: 5% for 6 months; 10% for 12 months paid in advance.

READER RATE: For individuals with a personal item to buy or sell. 50¢ per word (including name and address). No minimum! Payment must accompany copy.

GENERAL INFORMATION: First word in all ads set in bold caps at no extra charge. Additional words may be set in bold caps at 10¢ extra per word. All copy subject to publisher's approval. **Closing Date:** 1st of the 2nd preceding month (for example, March issue closes January 1st). Send order and remittance to: Hal Cymes, **ELECTRONICS WORLD**, One Park Avenue, New York, New York 10016.

FOR SALE

JUST starting in TV service? Write for free 32 page catalog of service order books, invoices, job tickets, phone message books, statements and file systems. Oelrich Publications, 4040 North Nashville Avenue, Chicago, Ill. 60634.

GOVERNMENT Surplus Receivers, Transmitters, Snooperscopes, Radios, Parts, Picture Catalog 25¢. Meshna, Nahant, Mass. 01908.

METERS Surplus, new, used, panel or portable. Send for list. Hanchett, Box 5577, Riverside, Calif. 92507.

CONVERT any television to sensitive big-screen oscilloscope. Only minor changes required. No electronic experience necessary. Illustrated plans, \$2.00. Relco-A22, Box 10563, Houston, Texas 77018.

INVESTIGATORS, LATEST ELECTRONIC AIDS. FREE LITERATURE. CLIFTON, 11500-J NW 7th AVE., MIAMI, FLORIDA 33168.

FREE ELECTRONICS PARTS FLYER. Large catalog \$1.00 deposit. BIGELOW ELECTRONICS, BLUFFTON, OHIO 45817.

EUROPEAN wholesale new products catalog. \$1.00 refundable. Deecow, 10639 Riverside, North Hollywood, Calif. 91602.

TREASURE HUNTERS! Prospectors! Relco's new instruments detect buried gold, silver, coins. Kits, assembled models, Transistorized. Weighs 3 pounds. \$19.95 up. Free catalog. Relco-A22, Box 10839, Houston Texas 77018.

MUSIC LOVERS, CONTINUOUS, UNINTERRUPTED BACKGROUND MUSIC FROM YOUR FM RADIO, USING NEW INEXPENSIVE ADAPTER. FREE LITERATURE, ELECTRONICS, 11500-Z NW 7th AVE., MIAMI, FLORIDA 33168.

JAPAN & HONG KONG DIRECTORY. Electronics, all merchandise. World trade information. \$1.00 today. Ippano Kaisha Ltd., Box 6266, Spokane, Washington 99207.

FREE Catalog low priced, high performance sub-miniature listening devices direct from manufacturer. Dealers welcome. Emery LT-101, 156 Fifth Avenue, New York, N.Y. 10010.

ULTRA-SENSITIVE AND POWERFUL METAL DETECTORS—join the many who are finding buried coins, minerals, relics and artifacts. Don't buy till you see our FREE catalog of new models. Write Jetco, Box 132-EW, Huntsville, Texas 77340.

SENGORE TEST EQUIPMENT UNBELIEVABLE PRICES. FREE CATALOG AND PRICE SHEET. FORDHAM RADIO, 265 EAST 149TH STREET, BRONX, N.Y. 10451.

SEMICONDUCTORS and Parts. Catalogue free over 100 pages. J. & J. Electronics, Box 1437, Winnipeg, Manitoba, Canada. U.S. Trade directed.

ELECTRONIC ignition, various types. Free literature. Anderson Engineering, Epsom, N.H. 03239.

HeNe GAS LASER output 3/4 M.W. typical completed tube with internal mirrors and P.S. schematic laser in the visible red. The best in the world in its class. Rush your order to C.W. Radiation, P.O. Box 1299, Mtn. View, Calif. 94040.

REPAIR TELEVISION TUNERS. FREE TRICKS. Plans, Details, Complete Courses: Frank Bocek, Box 3236 (Enterprise), Redding, Calif. 96001.

SEND for a copy of our new catalog describing the entire line of SINCLAIR, England's largest supplier of specialty audio electronics. Catalog includes tuners, amplifiers, modules and more. Available in the U.S. from many dealers or from AUDIONICS, INC., 9701 S.E. Mill, Portland, Oregon 97216.

LO-VOLT circuit tester. Handiest ever! Free Catalog. Mathco, 4256-2 Minnor, Cincinnati, 45217.

PLANS AND KITS

PLANS: LASER. \$2.00. Two FM Bugs. \$1.00. Tailing Bug. \$1.00. Telephone Bug. \$1.00. Infinity Transmitter. \$2.00. Howard, 20174 Ward, Detroit, Michigan 48235.

INTEGRATED CIRCUIT KITS: COMPUTER, AUDIO, Others. 1970 catalog free. KAYE ENGINEERING, Box 3932-B, Long Beach, California 90803.

ELECTRONICS ENGINEERING AND INSTRUCTION

LEARN ELECTRONIC ORGAN SERVICING at home. All Makes including transistors. Experimental kit—troubleshooting. Accredited NHSC. Free Booklet. NILES BRYANT SCHOOL, 3631 Stockton, Dept. A, Sacramento, Calif. 95820.

DEGREE in Electronics Engineering earned mostly by correspondence. Free brochure. Dept. G-9, Grantham School of Engineering, 1505 N. Western Ave., Hollywood, California 90027.

R.E.I.'s famous (5) week course for the First Class Radio Telephone License is the shortest, most effective course in the nation. Over 98% of R.E.I. graduates pass F.C.C. exams for 1st class license. Total tuition \$360.00. Job placement free. Write for brochure Radio Engineering Incorporated Schools, 1336 Main Street, Sarasota, Florida 33577—or 3123 Gillham Road, Kansas City, Missouri 64109—or 809 Caroline Street, Fredericksburg, Virginia 22401—or 625 E. Colorado Street, Glendale, California 91205.

FCC First Class License in six weeks—nation's highest success rate—approved for Veterans Training. Schools in Dallas, Atlanta, Chicago, New Orleans, Minneapolis and Houston. Write Elkins Institute, 2603C Inwood Road, Dallas, Texas 75235.

F.C.C. License training by correspondence. G.I. Bill approved. Money-Back Warranty. Free brochure. Write: Dept. Z-9, Pathfinder School of Electronics, 1505 N. Western Ave., Hollywood, Calif. 90027.

MEMORIZE, STUDY: "1970 TESTS-ANSWERS" FOR FCC FIRST AND SECOND CLASS LICENSE. Plus "Self-Study Ability Test." Proven. \$5.00. Command, Box 26348-W, San Francisco 94126.

ELECTRONICS! Associate degree—29 months. Technicians, field engineers, specialists in communications, missiles, computers, radar, automation. Start February, September. Valparaiso Technical Institute, Dept. N, Valparaiso, Indiana 46383.

TUBES

TUBES—33¢ each. Year guarantee. Tuner Cleaner \$1.00. Free catalog. Cornell, 4213-W University, San Diego, Calif. 92105.

TUBES, SEMICONDUCTORS, ELECTRONIC EQUIPMENT & COMPONENTS. Quality merchandise only! Serving engineers, Purchasing Agents, TV/HIFI Servicemen and Hams for 20 years. Write for Catalog or call 212-WA 5-7000. BARRY ELECTRONICS, 512 Broadway, New York, N.Y. 10012.

RECEIVING & INDUSTRIAL TUBES, TRANSISTORS, All Brands—Biggest Discounts. Technicians, Hobbyists, Experimenters—Request FREE Giant Catalog and SAVE! ZALYTRON, 469 Jericho Turnpike, Mineola, N.Y. 11501.

TUBES—Lowest world prices. Foreign-American. Obsolete, current. Receiving, Special Purpose, Transmitting tubes. Send for tube and parts catalog. United Radio Company, 56-E Ferry St., Newark, N.J. 07105.

WANTED

QUICKSILVER, Platinum, Silver, Gold. Ores Analyzed. Free Circular. Mercury Terminal, Norwood, Mass. 02062.

QUICK CASH . . . For Electronic Tubes, Semiconductors, Equipment (Receivers, Transmitters, Scopes, Vacuum Variables, etc.) Send lists now! Write: BARRY ELECTRONICS, 512 Broadway, New York, N.Y. 10012 (212-WA 5-7000).

TAPE AND RECORDERS

BEFORE renting stereo Tapes, try us. Postpaid both ways — no deposit — immediate delivery. Quality — Dependability — Service — Satisfaction — prevail here. If you've been dissatisfied in the past, your initial order will prove this is no idle boast. Free Catalog. Gold Coast Tape Library, Box 2262, Palm Village Station, Hialeah, Fla. 33012.

HIGH-SENSITIVITY WIDE-BAND RECEIVER COMMUNICATIONS • BUG DETECTION • SPECTRUM STUDIES

38-1000 MHZ AN/ALR-5: Consists of brand new tuner/converter CV-255/ALR original factory pack and an exc. used, checked OK & grid main receiver R-444 modified for 120 v. 50/60 Hz. The tuner covers the range in bands of each mode has its own Type M Ant. input. Packed with each tuner is the factory inspector's checkout sheet. The one we opened showed **SENSITIVITY:** 1.1 μ V at 775 mhz., 7 at 1 khz. mhz., 5 at 535 mhz., 4 1/2 at 95.4 mhz., 0.9 at 133 mhz. The receiver is actually a 30 mhz IF ampl. with all that follows, including a diode meter for relative signal strengths; an attenuator calibrated in 8 db steps to -74 db, followed by an AVC position; Pan., Video & AF outputs; switch select pass of \pm 200 khz or \pm 2 mhz; and SELECT AM or FM. With Handbook & pwr. input plug, all only **275.00**

R-595/ARR-7AX: Double-conversion version of R-45 Receiver. 550 khz to 43 mhz. Cascode input ckt. S-Meter, BFO, etc. With pwr. spl., ready to use checked, aligned, grtd. **190.00**

SP-600-JX (*) Rcvr: 0.54-54 mhz. the popular late-type Hammarlund Super-Pro, aligned, grtd. exc. physical cond. too, w/hook. **325.00**

R-390/URR Rcvr: Collins xtl-synthesizing driftless receiver, grtd 100% perfect **795.00**

COMPLETE EMPIRE DEVICES RFI METER NF-105 with 5 heads like new, recently calib., but we will get it recalib. prior to shipping. Factory authorized Second. Standards Lab. Covers 14 khz to 1000 mhz. Meets FED STD 222; Nasa MSPC-279, 280; MIL 285 (DOD), 484 (DOD), 752 (ships), R26 (USAF) etc. etc. HEADS:

Head	Frequency	Bands Sens.	Width
TX	14-150 khz	3 .1 uv	1 khz
TA	0-150 mhz	6 1 uv	10 khz
T1	20-200 mhz	2 10 uv	125 khz
T2	200-400 mhz	2 10 uv	225 khz
T3	0-4.1 ghz	2 10 uv	400 khz

Measurement accuracy as a 2-terminal coltmeter: \pm 1 db. Value of this set is \$10,435.00. Here is a very rare chance to get it for only **5000.00**

FAIRCHILD SOLID-STATE SCOPES all w/dual-trace plug-ins 25, 50 mc, w/delayed time-base plugs, w/hooks, w/recent NBS-traceable calib. **825.00**

CALIBRATED & GRD SIGNAL GENERATORS: Bonton #202B FM-AM generator 54 to 216 mhz. Deviation calib. on meter 0-24, 0-80, and 0-240 khz. AM calib. on meter 0-50%. **595.00**
Meas. Corp. #82: 20 Hz to 50 MHz CW or AM up to 50%. Output calib. to 1 v into 50 ohms. It is the only LF Gen. with Piston Attenuator: easy to use, no resistor burnouts. **450.00**
Gen. Radio 1001A .005-50 mhz. **595.00**
Meas. Corp. #80: 2-400 mhz. **299.50**
Marconi TF-801D/1: 10 to 470 MHz CW & AM up to 30% Xtl-calib. each 5 MHz and resettable dial handling. AGC keeps level constant. 0.1 uv to 1 v from 50 ohms into Type N. Cap. coupled turret switch, no rubbing contacts. Practically zero leakage & EM **595.00**

WE PROBABLY HAVE THE BEST INVENTORY OF GOOD LAB TEST EQUIPMENT IN THE COUNTRY. BUT PLEASE DO NOT ASK FOR CATALOG! ASK FOR SPECIFIC ITEMS OR KINDS OF ITEMS YOU NEED! WE ALSO BUY! WHAT DO YOU HAVE?

R. E. GOODHEART CO. INC.

Box 1220-A, Beverly Hills, Calif. 90213
Phones: Area 213, office 272-5707, messages 275-5342

TAPEMATES make available to you **ALL 4-TRACK STEREO TAPES—ALL LABELS**—postpaid to your door—at tremendous savings. For free brochure write: **TAPEMATES**, 5727 W. Jefferson Blvd., Los Angeles, California 90016.

RENT 4-track open reel tapes—all major labels—8,000 different—free brochure. Stereo-Parti, 55 St. James Drive, Santa Rosa, Calif. 95401.

CASSETTE blanks, also educational and language, accessories and recorders. Literature—write **CASSETTES UNLIMITED**, P.O. Box 13119W, Pittsburgh, Pa. 15243.

TAPES . . . blank recording . . . pre-recorded music. Catalog 10¢. Tower, Lafayette Hill, Pa. 19444.

STEREO TAPES, save 20, 30% and more, post-paid anywhere U.S.A. We discount batteries, recorders, tape/cassettes, 80-page catalog 25¢. **SAXITONE TAPES**, 1776 Columbia Road, N.W., Washington, D.C. 20009.

CLASSIC Radio Shows! Custom taped! Huge catalogue, 50¢. Radio Ltd., P.O. Box 23, Ann Arbor, Michigan 48107.

OLD Radio Programs on tape. 6 hours for \$8.00. Catalog 50¢. Don Maris, 824 Owl, Norman, Okla. 73069.

DO-IT-YOURSELF

PROFESSIONAL ELECTRONICS PROJECTS—\$1.00 up. Catalog 25¢. **PARKS**, Box 25665A, Seattle, Wash. 98125.

RECORDS

SPECIAL INTEREST RECORDS AVAILABLE, PRODUCED BY THE EDITORS OF THE WORLD'S LEADING SPECIAL INTEREST MAGAZINES. SEND FOR FREE CATALOG. RECORD CATALOGUE, ZIFF-DAVIS PUBLISHING COMPANY, ONE PARK AVENUE, NEW YORK, N.Y. 10016.

POPULAR organ albums factory direct. Concert Recording, Lynwood, Calif. 90262.

HIGH FIDELITY

TRADE IN YOUR OLD CARTRIDGE: Send us \$6.95 and we will ship **PREPAID** any one of the following: ADC 220; Grado FTR; Pickering PAC 1; Shure M3D. **LYLE CARTRIDGES**, 265 East 149th St., Bronx, New York 10451.

FREE! Send for money saving stereo catalog #E1W and lowest quotations on your individual component, tape recorder or system requirements. Electronic Values, Inc., 200 West 20th Street, N.Y., N.Y. 10011.

TRADE IN YOUR OLD CARTRIDGE: Send us \$17.95 and we will ship **PREPAID** any one of the following: ADC 660E; Empire 888E; Pickering V15ATE-3; Pickering V15AME-3; Pickering XV15-AT; Shure M55E; Shure M75E; Shure M92E; Shure M93E; Stanton 500E. **LYLE CARTRIDGES**, 265 East 149th Street, Bronx, New York 10451.

HI-FI Components, Tape Recorders at guaranteed "We Will Not Be Undersold" prices. 15-day money-back guarantee. Two-year warranty. No Catalog. Quotations Free. Hi-Fidelity Center, 239 (L) East 149th Street, New York 10451.

HI-FI components, tape recorders, sleep learning equipment, tapes. Unusual Values. Free catalog. Dressner, 1523 R Jericho Turnpike, New Hyde Park, N.Y. 11040.

TRADE IN YOUR OLD CARTRIDGE: Send us \$10.95 and we will ship **PREPAID** any one of the following: ADC 770; Empire 808, Grado FTE; Pickering V15AC-3; Pickering V15AT-3; Shure M7/N21D; Shure M44-5; Shure M44-7. **LYLE CARTRIDGES**, 265 East 149th Street, Bronx, New York 10451.

HI-FI EQUIPMENT—GET Our "ROCK BOTTOM" prices on **NAME BRAND** amplifiers—tuners—tape-recorders—speakers **FRANCHISED—60 YEARS IN BUSINESS.** Write for this month's specials—**NOW!** Rabson's 57th St., Inc., Dept. 569, 119 W. 57th St., New York, New York 10019.

LOW, LOW quotes: all components and recorders. Hi-Fi, Roslyn, Penn. 19001.

TRADE IN YOUR OLD CARTRIDGE: Send us \$39.95 and we will ship **PREPAID** any one of the following: ADC 10EMKII; Empire 888VE; Pickering XV750E; Stanton 681EE; Empire 999VE. **LYLE CARTRIDGES**, 265 East 149th Street, Bronx, New York 10451.

AMAZING DISCOUNTS on famous brand high fidelity stereo components. No small wonder that we have set new sales records each year since 1959. Write: Arkay Electronics, 1028-02 Commonwealth, Boston, Mass. 02215.

**INTEGRATED CIRCUITS / RECTIFIERS
SEMICONDUCTORS / TRIACS**

TRIACS

PRV	5 AMP	10A
100	.90	1.20
200	1.40	1.75
300	1.75	2.25
400	2.25	2.75
500	2.60	3.25

ER900 TRIGGER DIODES. These bidirectional trigger diodes are one of the best and cheapest methods to trigger SCR's and triacs 3/\$1.00

UNIUNCTIONS!

Similar to 2N2419. RBB of 5-7 stand off ratio of .6 and Ip of 12 with data sheet **SPECIAL** \$1.00

ZENERS 750 Milliwatt 7-68V \$.40
10 Watt 7-180V \$.75

**MOUNTING
HARDWARE KITS.**

These kits are used to mount our SCR's Zeners and Rectifiers etc.
6x32 stud (3, 12 amp rectifiers,
7A SCR's) 6 sets/\$1.00

1/4x28 stud (30 amp. rectifiers,
20 amps SCR's.) 4 sets/\$1.00

Send for our latest catalog featuring Transistors and Rectifiers; 325 Elm St., Cambridge, Mass.

2N1163 a TO-3 PNP GERMANIUM TRANSISTOR rated at 35v and a gain of 50 at 25 amps. \$1.75

N-CHANNEL FET'S TO-18 plastic units, low noise, low leakage, 25 volts source to gate, 50 ma gate current Gain to 9000 μ mo's. \$.80

NEON LIGHT OR NIXIE TUBE DRIVERS. An NPN, TO-18, SI Transistor. With a VCBO of 120

3/\$1.00
9030 8 BIT MEMORIES \$3.95

DIGITAL RTL CIRCUITS

900 Buffer \$.75

925 Dual 2 Input gate expander \$.75

923 JK flip flop \$1.00

Silicon Power Rectifiers

PRV	3A	12A	30A
100	.09	.30	.50
200	.16	.50	.80
400	.20	.70	1.20
600	.30	1.00	1.50
800	.40	1.25	1.80
1000	.55	1.50	2.20

Terms: FOB Cambridge, Mass. Send check or Money Order. Include Postage. Average Wt. per package 1/2 lb. No C.O.D.'s. Minimum Order \$3.00

**WE LEAD THE WAY
IN SERVICE AND QUALITY!**

Rated companies 30 days net

FIBRE OPTICS

1/32" 2.5 Mil. Fibers in PVC Jacket 40¢/Ft. Complete Light Guide Bundle. Consisting of an 11" length of 1/32" dia. fiber optics with bound ends \$2.00 Ea.

LINEAR CIRCUITS

CA 3011 FM IF AMPLIFIER \$.90
709C OPERATIONAL AMPL. \$1.75
710C HI SPEED DIFF. AMP. \$1.75
711C DUAL COMPARATOR \$1.75

Controlled Avalanche or Epoxy Rectifiers 1 AMP.

PRV	
100	.07
200	.09
400	.12
600	.18
800	.22
1000	.35

Silicon Control Rectifiers

PRV	3A	7A	20A	70A
50	.35	.45	.70	
100	.50	.65	1.00	4.00
200	.70	.95	1.30	8.00
300	.90	1.25	1.70	
400	1.20	1.60	2.10	12.00
500	1.50	2.00	2.50	
600	1.80	2.40	3.00	16.00

SOLID STATE SALES

Post Office Box 74B

Somerville, Mass. 02143

Tel. (617) 547-4005

CIRCLE NO. 107 ON READER SERVICE CARD

\$1 PEP \$1
1 Dollar Sale
EACH PACKAGE
MONEY BACK GUARANTEE

1 AMP Silicon Rectifier
Choice of Package
Bullet-Glass-Min-Metal
4-200V 4-1000V 5-800V
12-200V 3-1200V

ZENER—DIODES
250-400 MW
1 EA 4V-6V-8V-10V

1 WATT
1 EA 4V-6V-8V-10V

3 AMP
16-60V 4-600V
10-100V 3-800V
8-200V 2-1000V
6-400V 1-1200V

2 WATT
12 to 60V
CHOICE OF THREE

5 AMP
10-60V 4-400V
8-100V 3-800V
6-200V 2-1000V
6-500V 1-1200V

16 Bit Memory Cell—\$4.25

12 AMP STUD
4-100V 2-800V
3-500V 1-1000V

SILICON-CONTROLLED RECTIFIER
TO-5 PACKAGE
5-50V 2-200V \$1.00
4-100V 2-400V \$1.25

20 AMP STUD
4-30V 2-900V
3-100V 1-1000V

7 AMP SCR
4-60V \$1.00 1-500V \$1.00
3-100V 1.00 1-800V 1.50
2-200V 1.00

40 AMP STUD
3-60V 1-300V
2-100V

GENERAL PURPOSE GERMANIUM TRANSISTOR
SIMILAR to 2N404
8 UNITS

60 AMP STUD
(3-50V-\$1.00
(1-1000V-1.25
(60 AMP STUD

RADIATION FREE TUBE FOR COLOR TV
50,000 Volts. Replaces RCA 3A-3A or equivalent. Guaranteed for life of set or 5 years. Eliminates heat to prolong life of other tubes. \$8.99 each.

SPECIAL INTEGRATED CIRCUITS
Dual 4 Input Nand Gate Digital \$1.50
Quad 2 Input Nand Gate Digital \$1.50
JK Flip Flop Master Gate Digital \$1.75
Linear 1 C Operational Amp 709C Type. \$1.75

NO SALES TAX—WE PAY POSTAGE
OTHER PRODUCTS ON REQUEST
PARK ELECTRONIC PRODUCTS
P.O. Box 78, N. Salem, N.H. 03073
603-893-0276

RECTIFIERS & TRANSISTORS

Silicon Rectifiers

PIV	25	50	100	200	400	600	800	1000	1200
1A*	—	.03	.04	.06	.08	.10	.14	.17	.22
3A	—	—	—	—	.11	.15	.22	.30	.38
18A**	.09	.15	.19	.29	.39	.49	—	—	—
20A	.15	.20	.25	.39	.50	.75	.90	1.15	1.40
40A	.25	.35	.60	.90	1.20	1.50	1.80	2.10	2.40

*Tophat. Flangeless. **Pressfit. 3, 20, 40 Studs

Silicon Controlled Rectifiers

1500 PIV STUD	PRV	25	50	100	200	400	600
1 AMP	1A*	—	—	—	.30	.45	.85
25¢ EA.	7A	.11	.14	.20	.45	.90	1.20
	18A**	.15	.23	.35	.60	1.10	1.40
	20A	.18	.32	.45	.70	1.15	1.95

*Tophat **Pressfit. 7 & 20 Amp Stud

Germanium Power Transistors
150W-TO-3-7A
2N456A-40V-.25 2N 458A- 80V-.45
2N457A-60V-.35 2N1021A-100V-.60
2N1038-40V-8/\$1.00-20W TO-5-3A

Silicon Power Transistors
2N 389A 85W, 60V-.55 2N1048A 40W 120V-.55
2N 424A 85W, 80V-.65 2N1718 10W 60V-.15
2N 497 4W, 60V-.10 2N1719 10W 100V-.20
2N 498 4W, 100V-.12 2N1724 50W 80V-.65
2N1047A 40W, 80V-.40 2N2151 30W 80V-.25

Silicon Small Signal NPN, TO-5
2N696 7/1.00, 2N697 6/\$1.00, 2N699 5/\$1.00
3N34 Tetrode-60¢; IN34A Diodes 100/\$2.98;
2N1142 Ger. Hi-Freq. Amplifier 4/\$1.00; Thermistor Beads, 5000 ohm or 1200 ohm-3/\$1.00; Varicaps-27, 47, or 100 pf, 4V-\$1.25 ea.; P.C. Board 8"x8" 1/16"-1 oz. Copper-2/98¢; Photo Cells, Herm. Glass, 5 Diff. for \$1.00; 2N1300 Series, TO-5 Assorted-25/\$1.00; I.C. R.F. Coil Assort. 25/\$1.00, TO-5-15/\$1.00.

ASSORTMENTS

Precision resistors film 50/\$1.00
Precision resistors wirewound 40/\$1.00
Ferric Chloride Etchant, 16 oz. bottle98
Relays 6 different types 6/\$1.00
Terminal lugs, assorted 200/\$1.00
Tie lugs, assorted 50/\$1.00
Push button switches, on-off, panel 6/\$1.00
Pots, 2-4 watt, assorted 15/\$1.00
Free \$1.00 pack with \$10.00 order; min. order \$3.00; send sufficient postage, coverage refunded; fully guaranteed; free catalog.

GENERAL SALES CO.

254 Main (713) 265-2369
Clute, Tex. 77531

\$100.00 INTEGRATED CIRCUIT PENNY SALE!

Imagine — buy 1 Integrated Circuit at our bargain price get the 2nd one for ONLY 1¢ . . .

Fairchild No.	Part	1 for 1.49	2 for 1.50	4 for 1.99	1c MORE
900	Buffer	1 for 1.49	2 for 1.50	4 for 1.99	
903-903*	3 Input gate Nand/Nor	2 for 1.98	4 for 1.99	2 for 1.50	
910	Dual Two Input Gate	1 for 1.29	2 for 1.50	4 for 1.99	
910-910	Dual Two Input Gate	2 for 1.98	4 for 1.99		
914	Dual Two Input Gate	1 for 1.29	2 for 1.30	4 for 1.99	
914-914*	Dual Two Input Gate	2 for 1.98	4 for 1.99		
915	Dual 3 Input Gate Nand/Nor	1 for 1.49	2 for 1.50	4 for 1.70	
915-915	Dual 3 Input Gate Nand/Nor	2 for 1.69	4 for 1.70		
923	JK Flip Flop	1 for 1.49	2 for 1.50	4 for 1.99	
923-923*	JK Flip Flop	2 for 1.98	4 for 1.99		
925	Dual 2 Input Gate, Expander	1 for 1.49	2 for 1.50	4 for 1.99	
927	Quad Inverter	1 for 1.49	2 for 1.50	4 for 1.99	
930	Dual 4 Input Gate Nand/Nor	1 for 1.49	2 for 1.50	4 for 1.99	
933	Dual Input Gate, Expander	1 for 1.49	2 for 1.50	4 for 1.99	
944	Dual 4 Input Power Gate	1 for 1.49	2 for 1.50	4 for 1.99	
945	Clocked Flip Flop	1 for 1.69	2 for 1.70	4 for 1.99	
946	Quad 2 Input Gate Nand/Nor	1 for 1.49	2 for 1.50	4 for 1.99	
948	Clocked Flip Flop	1 for 1.98	2 for 1.99	4 for 1.70	
953	2-2-3-Input and Gate	2 for 1.69	4 for 1.70		

EPOXY SILICON TRANSISTORS 5 for \$1

Type	Sale
2N706	5 for \$1
2N2222	5 for \$1
2N2368	5 for \$1
2N2711	5 for \$1
2N3396	5 for \$1
2N3565	5 for \$1
2N3568	5 for \$1
2N3638	5 for \$1
2N3641-3	5 for \$1
2N3645	5 for \$1
2N3662	5 for \$1
2N3683	5 for \$1
2N3692	5 for \$1
2N3793	5 for \$1
2N4140-1	5 for \$1
2N4248-9	5 for \$1
2N4284-5	5 for \$1
2N4288-9	5 for \$1
2N4290-1	5 for \$1

INTEGRATED CIRCUIT AUDIO AMPLIFIER! 709C OP AMP

★ 8 Transistors ★ Dime Size **149** **AMPLIFIER**

Never before offered! Self-contained, integrated circuit—size of a DIME! TO-5 case, 8 leads. Use for phono, tape, intercom & 100's of micro-miniature audio circuits, mike, phono, tape. Output: 3 to 16 ohm speaker. Complete with data.

Guaranteed! With Spec. **149**

TYPICAL USES: AC AMPLIFIER, Hi-Fi PHONO, PREAMP, INTEGRATOR, MULTIPLIER

2 AMP SILICON 800 PIV RECTIFIERS 6 for \$1

Terms: add postage. Rated: net 30, cod's 25%
Phone Order: Wakefield, Mass. (617) 245-3829
Retail: 211 Albion, St., Wakefield, Mass.

SALE ON FAIRCHILD COUNTING "ICs"

3 for \$15 **\$5.95**

Guaranteed!

No.	Description
958	Decade Counter
959	Buffer-Memory
960	Decoder-Driver

POLY PAKS

P.O. BOX 942 W LYNNFIELD, MASS 01940

TRADE IN YOUR OLD CARTRIDGE: Send us \$13.95 and we will ship PREPAID any one of the following: Empire 808E; Empire 888; Pickering V15AM-3; Pickering V15ACE-3; Pickering V15AC; Shure M31E; Shure M32E; Shure M44E; Shure M75-6. LYLE CARTRIDGES, 265 East 149th Street, Bronx, New York 10451.

BACKGROUND MUSIC—SOLID-STATE SCA DECODER DELIVERS SUBCARRIER COMMERCIAL-FREE MUSIC PIGGYBACKED ON MANY FM STATIONS. LINE-POWERED ADAPTER SIMPLY PLUGS INTO ANY FM TUNER. NO ADJUSTMENTS OR TUNING. NEW DESIGN BREAKTHRU GUARANTEES OPTIMUM PERFORMANCE. LOWEST PRICE EVER! \$35 POSTPAID. K-LAB, BOX 572, S. NORWALK, CONN. 06856.

DON'T THROW YOUR OLD CARTRIDGE AWAY. Send us \$19.95 and any old cartridge. We will ship PREPAID any one of the following top rated elliptical diamond stereo cartridges NEW: Shure M75E, M91E, M92E, Empire 888E, Pickering V15AME3, XV15 ATE, ADC 660E, 550E. Write for lowest quotations all stereo components. Send \$1.00 for our discount catalog. DEFA ELECTRONICS, 2207 Broadway, New York, N.Y. 10024.

GOVERNMENT SURPLUS

JEEPS Typically From \$53.90 . . . Trucks From \$78.40 . . . Boats, Typewriters, Airplanes, Multi-meters, Oscilloscopes, Transceivers, Electronics Equipment. Wide Variety, Condition, 100,000 Bid Bargains Direct From Government Nationwide. Complete Sales Directory and Surplus Catalog \$1.00 (Deductible First \$10.00 Order). Surplus Service, Box 820-K, Holland, Michigan 49423.

AUTHORS' SERVICES

AUTHORS! Learn how to have your book published, promoted, distributed. FREE booklet "ZD." Vantage, 120 West 31 St., New York 10001.

PERSONALS

MAKE FRIENDS WORLDWIDE through international correspondence. Illustrated brochure free. Hermes, Berlin 11, Germany.

HYPNOTISM

FREE Hypnotism, Self-Hypnosis, Sleep Learning. Catalog! Drawer H400, Ruidoso, N.M. 88345.

HYPNOTIC Sleep Learning recordings produce fabulous results. Details free. ASR Foundation, Box 7021cg Henry Clay Station, Lexington, Kentucky 40502.

AMAZING self-hypnosis record releases fantastic mental power. Instant results! Facts free. Write: Forum (AA1), 333 North Michigan Avenue, Chicago 60601.

PRACTICAL GUIDE to SELF-HYPNOSIS 145 pages \$2.00. MONEY BACK GUARANTEE. FREE CATALOG on OCCULT and SELF-IMPROVEMENT BOOK. Stark Enterprise, 2309 Columbus Ave., Fort Worth, Texas 76106.

PHOTOGRAPHY—FILM EQUIPMENT—SERVICES

SCIENCE Bargains—Request Free Giant Catalog "CJ"—148 pages—Astronomical Telescopes, Microscopes, Lenses, Binoculars, Kits, Parts, War Surplus bargains. Edmund Scientific Co., 300 Edscorp Bldg., Barrington, New Jersey 08007.

MAGNETS

MAGNETS. All types. Specials—20 disc magnets, or 2 stick magnets, or 10 small bar magnets, or 8 assorted magnets, \$1.00. Maryland Magnet Company, 5412-E Gist, Baltimore, Maryland 21215.

EDUCATIONAL OPPORTUNITIES

LEARN ACCIDENT INVESTIGATION. Train at home to earn \$750 to \$1,000 monthly. Car furnished. Expenses paid. No selling. No college needed. Full or spare time. Men urgently needed. Free placement service. Write for FREE information. No obligation. Universal Schools CZ-1, 6801 Hillcrest, Dallas, Texas 75205.

LEARN WHILE ASLEEP, Hypnotize! Strange catalog free. Autosuggestion, Box 24-ZD, Olympia, Washington 98501.

U.S. GOV'T ELECTRONIC SURPLUS

Nationally Known-World Famous SURPLUS CENTER offers finest, most expensive, Government Surplus electronic units and components at a fraction of their original acquisition cost.

ORDER DIRECT FROM AD OR WRITE FOR CATALOGS

COMPUTER TRANSISTORS ON HEAT SINKS

IBM Computer Quality Units

• (#22-928) -- Unit consists of one 150-watt power transistor on heavy, ribbed, aluminum heat sink. Many experimental uses. (1 lb.) **\$1.99**
Cost Gov't Over \$10.00

• (#22-916) -- Unit consists of two 150-watt power transistors, 3 pots., several diodes, capacitors, resistors, etc. on heavy, ribbed aluminum heat sinks. Ideal for use as motor speed control. (4 lbs.) **\$4.91**
Cost Gov't Over \$35.00

RUNNING TIME METER

• (#DX-104) -- Use to record number of operating hours of electric lights and electrical devices such as refrigerators, furnaces, etc. Records total hours, tenths and hundredths up to 9,999.99 hours. For 115-volt, 60-cycles. Size 4 1/2" x 3 1/2" x 2 1/2". Shipping weight 2 lbs. **\$3.69** Cost Over \$29.00

12 and 24-VOLT TRANSFORMER

• (#15-920) -- General Electric 115-volt, 60-cycle to 12 and 24-volts & 750-watts. Capacity 42-amps. @ 24-volts, 64-amps. at 12-volts. Useful for battery chargers, running DC motors, etc. 7 1/2" x 3 1/2" x 3 1/2". (18 lbs.) Cost Gov't Over \$35.00 **\$16.72**

EXPANDED SCALE 0 - 15 DCVM

• (#21-900) -- Brand new, expensive voltmeter reads 0.5 to 15-volts DC and 3 to 30-volts AC. Useful for automotive and aircraft battery charge indicator, etc. D'Arsonval movement, black phenolic case. 7 1/2" x 3 1/2" x 3 1/2". (3 lbs.) List \$32.50 **\$12.95**

SURPLUS TELETYPEWRITERS

• (ITEM #22-916) -- Used but excellent teleprinter, Model 15 complete with A.P. Co. Data-Cam. Permits using teleprinter over regular long distance connection. Complete with AC power supply, control telephone, etc. Wt. 960 lbs. Size 22" x 22" x 32". **\$249.50**

• Also have limited number Model 19 Teleprinters with perforator, Data-Cam, etc. Write for sale price.

SEND 25c COIN OR STAMPS FOR CATALOGS

All items FOB Money Back Guarantee

SURPLUS CENTER

DEPT. EW-170 LINDOLN, NEBR. 68501

CIRCLE NO. 105 ON READER SERVICE CARD

TG-34A CODE KEYS

Self-contained automatic, reproduces code practice signals from paper tape, 5 to 26 WPM. Built-in speaker. Brand New, with tech. manual, inkeep reel and AC line cord. Code practice tapes for above F.U.R. **\$29.50**

BC-645 TRANSCEIVER

15 tubes. 485 to 500 Mc. Easily adapted for 2 way voice or code on Ham, Mobile, Television, Experimental and Citizens' Bands. With tubes, less power supply in factory carton. Brand New **\$16.95**

SPECIAL PACKAGE OFFER: BC-645 Transceiver, Dynamotor and all accessories, including mounting, UHF Antenna Assemblies, control box, complete set of connectors, plugs, BRAND NEW **\$26.95**

TG-5B TELEGRAPH SET for code communications. Bell call system, 1000-cycle howler, key, headpiece, canvas case, book. Batteries not included. NEW **\$8.95**

SCR-274-N, ARC-5 COMMAND SET HQ!

Freq. Range	Type	Exc. Used	Like New	BRAND NEW
RECEIVERS. Complete with Tubes				
190-550 Mc.	BC-453	\$18.95	\$23.50	\$27.50
3-6 Mc.	BC-454	\$16.50	\$19.50	\$22.50
6-9.1 Mc.	BC-455	\$14.95	\$17.95	\$21.50
1.5-3 Mc.	R-25	\$19.50	\$19.50	\$21.50
TRANSMITTERS. Complete with Tubes				
4-5.3 Mc.	BC-457	\$ 6.95	\$ 8.95	\$11.95
5.3-7 Mc.	BC-458	\$ 6.95	\$ 8.95	\$12.95
7-9.1 Mc.	BC-459	\$11.95	\$19.50	\$23.50
2.1-3 Mc.	T-18	—	\$ 9.95	\$11.95
3-4 Mc.	T-19	—	\$12.50	\$16.95

R-11 COMMAND RECEIVER ARC 190-550 Mc. Commercial late model. Excellent Condition. **\$129.95**

AN/APR-4Y FM & AM RECEIVER "FB" FOR SATELLITE TRACKING!

High precision lab instrument, for monitoring and measuring frequency and relative signal strength, 38 to 4000 Mc, in 5 tuning ranges. For 110 V 60 cycle AC. Built-in power supply. Original circuit diagram included. Checked out, perfect. LIKE NEW **\$88.50**

All Tuning Units Available for Above

EE-8 FIELD PHONE, checked out, with batteries, excellent used, each **\$1695**

600-OHM HEADSET, permoflux units, chamois cushion, with cord & telephone plug, NEW... **\$349**

NEW G & G CATALOG! 24 PAGES, crammed with Gov't Surplus Electronic Gear. Biggest Bargain Buys in America! It will pay you to SEND 25c for your copy—Refunded with First Order!

TERMS: 25c deposit with order, balance C.O.D. —OR—Cash in Advance in Full. Minimum Order \$5.00. O.B. NYC. Subject to prior sale and price change.

G&G RADIO ELECTRONICS COMPANY

Tel.: (212) CO-7 4605
45 Warren St., 2nd Floor, New York, N.Y. 10007

EMPLOYMENT INFORMATION

FOREIGN and USA job opportunities available now. Construction, all trades. Earnings to \$3,000.00 monthly. Paid overtime, travel, bonuses. Write: Universal Employment, Woodbridge, Conn. 06525.

INVENTIONS WANTED

INVENTORS! Receive free invention analysis at no risk to you. Send for FREE disclosure form today. New York Invention Service, Dept. 19, 160 Broadway, New York, N.Y. 10038.

PATENT Searches including maximum speed, full airmail report and closest patent copies, \$6.00. Quality searches expertly administered. Complete secrecy guaranteed. Free Invention Protection forms and "Patent Information." Write Dept. 23, Washington Patent Office Search Bureau, 711 14th Street, N.W., Washington, D.C. 20005.

INVENTORS! Sell your invention for cash or royalties! Our client manufacturers eagerly seek new items. Patented. Unpatented. Financial assistance if needed. 25 years proven performance. For free information, write Dept. 25, Gilbert Adams, Invention Broker, 80 Wall St., New York, N.Y. 10005.

WE manufacture your invention. Details 10¢. P.O. Box 487, Miami (Kendall), Florida 33156.

STAMPS

RUSSIA high-value collection. 32 different Russia—some over 50 years old! Commemoratives, Czarist Issues, Animals, catalog price \$2.50. Special get-acquainted offer—all for only 10¢! H. E. Harris, Dept. GG-54, Boston, Mass. 02117.

MAGAZINES

BACK DATE MAGAZINES! Send needs. Midtown, Box 917-EW, Maywood, N.J. 07607.

BUSINESS OPPORTUNITIES

FREE CATALOGS. Repair air conditioning, refrigeration. Tools, supplies, full instructions. Doolin, 2016 Canton, Dallas, Texas 75201.

I MADE \$40,000.00 YEAR by mailorder! Helped others make money! Start with \$10.00—Free proof. Torrey, Box 318-N, Ypsilanti, Mich. 48197.

JAPANESE Electronics New Products Monthly! Specimen copy \$1, deductible. Dee, 10639-W Riverside, North Hollywood, Calif. 91602.

FREE BOOK "990 Successful Little-Known Businesses." Work home! Plymouth 445-R, Brooklyn, New York 11218.

MAKE BIG MONEY raising chinchillas, rabbits, guinea pigs for us. Catalog—25¢. Keeney Brothers, New Freedom, Pa. 17349.

TREASURE FINDERS

TREASUREPROBES patented transistorized detector signals "dig" by earphone "beeping." 5" search head, PC boards, two colpitt oscillators improve stability. Kit \$13.95, assembled \$18.88, with speaker \$24.88. 60 day guarantee. Free literature. Treasurehouse, EH10, Tennent, N.J. 07763.

RUBBER STAMPS

RUBBER ADDRESS STAMP \$2.00. SIGNATURE \$3.50. FREE CATALOG. JACKSON, BOX 443-G, FRANKLIN PARK, ILL. 60131.

MISCELLANEOUS

WINEMAKERS: Free illustrated catalog of yeasts, equipment. Semplex, Box 122-76, Minneapolis, Minn. 55412.

EMPLOYMENT Resumes. Get a better job & earn more! Send only \$2.00 for expert, complete Resume Writing Instructions. J. Ross, 80-34 Kent St., Jamaica, N.Y. 11432 Dept. EW.

CLASSIFIED ADVERTISING ORDER FORM

Please refer to heading on first page of this section for complete data concerning terms, frequency discounts, closing dates, etc.

1	2	3	4	5
6	7	8	9	10
11	12	13	14	15
16	17	18	19	20
21	22	23	24	25
26	27	28	29	30
31	32	33	34	35

_____ Words { @ .50 Reader Rate } = \$ _____
 { @ .85 Commercial Rate }
 Insert _____ time(s) Total Enclosed \$ _____

NAME _____

ADDRESS _____

CITY _____

STATE _____

ZIP _____

SIGNATURE _____

WORD COUNT: Include name and address. Name of city (Des Moines) or of state (New York) counts as one word each. Zip Code numbers not counted. (Publisher reserves right to omit Zip Code if space does not permit.) Count each abbreviation, initial, single figure or group of figures or letters as a word. Symbols such as 35mm, COD, PO, AC, etc., count as one word. Hyphenated words count as two words. EW-1-70

KEEP PACE WITH SPACE AGE! SEE MOON SHOTS—LANDINGS, SPACE FLIGHTS, CLOSE-UP!

AMAZING SCIENCE BUYS

for FUN, STUDY or PROFIT



Astronomical Telescope Kits

Grind your own mirror for powerful telescopes. Kits contain fine annealed pyrex mirror, blank tool, abrasives, diagonal mirror, and eyepiece lenses. Instruments you build are valued up to \$100's.

4 1/4" DIAMETER—3/4" THICK
 No. 70.003AK \$9.75 Ppd.
 6" DIAMETER—1" THICK
 No. 70.004AK \$13.95 Ppd.
 8" DIAMETER—1 3/8" THICK
 No. 70.005AK \$21.00 Ppd.
 10" DIAMETER—1 3/4" THICK
 No. 70.006AK \$34.25 FOB



Visual Effects Projector Set

Dazzling, avant-garde visual effects. Fantastic variety. Incredibly beautiful. Special package offer containing all necessary apparatus. Create fire, exploding fiery bursts of color like "Symphony of Spheres," "Chromatic Starbursts," "Crystal Starburst." Features 50mm 500 W. fan cooled projector, produces big image at short distance. Accepts two 3" diam. wheels (Dry Kaleidoscope & Hexidoscope). 2 cylindrical accessories (8" Colored Cloud & 8" Hexidoscope w/16 internal mirrored walls). Perfect for entertaining, parties, photography. Complete instructions.
 Stock No. 71,212AK .. \$79.50 Ppd.



Long-Wave Black Light Fixture

Extremely versatile, compactly designed, long wave (3200-4000 angstroms) black light (ultraviolet) fixture. Has 6-watt, 10-V lamp with built-in filter—eliminates harmful shorter wave ultraviolet rays. Use to identify minerals, fungi, bacteria—check for surface flaws, oil and gas leakage—perfect for displays with fluorescent paper, paints, chalk, crayons, trace powder. Incl. adjustable aluminum reflector, push-pull switch, connecting plug. Mount vert., hor., or on corner. 10" L., 1 1/2" W., 1 1/4" H.
 Stock No. 70.364AK .. \$12.00 Ppd.
 REPLACEMENT BULB
 Stock No. 60,124AK .. \$4.50 Ppd.



Psychedelic Lighting Handbook

100 information packed pages! Fully explains the latest in psychedelic lighting equipment, techniques, developments. Covers all facets of psychedelic light-show production . . . including strobes, black lights, projectors, crystals, organic slides, mirrors, color organs, polarized color, light boxes, MusicVision, etc. Shows how to "psychedelize" parties, musical groups, shows . . . or how to set up "electric trips" for your own private gatherings. 8 1/2" x 11" loose-leaf paper punched for 3 ring binder add new developments as they happen.
 Stock No. 9100AK . . . \$3.00 Ppd.



New \$99.50 Helium-Neon Laser!

Completely assembled, instant-starting w/three times power output of comparable models. Steady, ripple-free light of moderate (safe) power. Excellent collimation. Particularly useful for studies, experiments in holography, interferometry, diffraction, optical alignment. Simple and safe to use—just plug in, switch on. The 4 1/4 lb. unit reaches 75% power in 2 secs.; full power, typically 0.5 milliwatt (0.3 mW minimum) in 3 mins. Beam divergence only 2 milliradians (far ahead of competition); beam only 2 cms at 40 feet.
 Stock No. 79.004AK .. \$99.50 Ppd.

GIANT FREE CATALOG

148 Pages—1000's of Bargains

Completely new 1970 edition. New items, categories, illustrations. Dozens of electrical and electromagnetic parts, accessories. Enormous selection of Astronomical Telescopes, Microscopes, Binoculars, Magnifiers, Lenses, Prisms. Many war surplus items: for hobbyists, experimenters, workshop, factory. Mail coupon for catalog "AK" EDMUND SCIENTIFIC CO., 300 EDSCORP BUILDING, BARRINGTON, N.J. 08007

NAME _____
 ADDRESS _____
 CITY _____
 STATE _____ ZIP _____

ORDER BY STOCK NUMBER • SEND CHECK OR MONEY ORDER • MONEY-BACK GUARANTEE

EDMUND SCIENTIFIC CO. 300 EDSCORP BUILDING
 BARRINGTON, NEW JERSEY 08007

CIRCLE NO. 138 ON READER SERVICE CARD

GREGORY ELECTRONICS

**An Extensive Selection of
General-Electric
Progress Line 2-Way
Mobile Equipment**

30-50 MHz Vibrator Power
14" Case Complete Access.
Fully narrow-band (Tx & Rx)
MA/E 13 6/12v, 30w **\$178.**

MA/E 16 6/12v, 60w **\$198.**

MD/Y 16N 6/12v, 60w
Dynamotor Power Supply **\$138.**

MT/16 12v, 60w
Transistor Power Supply **\$228.**

148-174 MHz Vibrator Power
14" Case Complete Access.
Fully narrow-band

MA/E 33 6/12v, 30w **\$198.**

MA/E 36 6/12v, 60w
Vibrator Power Supply **\$228.**

FA/E 33 6/12v, 30w **\$188.**

MT/33-6/12v, 30w **\$228.**

MT/36-6/12v, 60w **\$248.**

450-470 MHz 15w Vibrator
Power Supply MA/E 42,
with accessories **\$148.**

MT 42 12v, 15w
Transistor Power Supply **\$198.**

**450-470 MHz General-Electric
Progress Line Accents**

10 watts, 12 volts/transistor power supply; front or
rear mount. Complete accessories. Model No. EG48S
Wide Band.....\$168 Narrow Band.....\$188
EG 48CT (Trunk) EG 48CF (Front)

GE Progress Line Receiver Strips 25-50 MHz
Narrow Band \$45.....Wide Band \$35.

BRAND NEW

DUMONT M430RTN 450-470 MHz Special!
50-watt transistor power supply meets latest
FCC narrow-banding specifications, 5 K.C.
deviations.

IN FACTORY-SEALED CARTONS **\$295.**

With tone added, minus reeds **\$345.**

MOTOROLA X43GGV Special!

In 10" case, 150-170 MHz, 30 watts with
accessories. Transmitter N.B., receiver W.B.
Transistorized receiver power supply and vi-
brator powered. 2 freq. transmitter. Receiver
only private line, single squelch, 2
freq. receiver. **\$158.**

Reconditioned & Used FM 2-Way Radio Equipment

We Buy Late Model Equipment for Cash
SEND FOR NEW CATALOG



**GREGORY
ELECTRONICS
CORPORATION**

249 RT. 46, Saddle Brook, N.J. 07662
Phone: (201) 489-9000

CIRCLE NO. 132 ON READER SERVICE CARD



TUBES
1 YR. GUARANTEED

Mutual Conductance Lim-Testing, Individually
Checked, Standard and Code Dates, Tubes
are new, or used and to match

- Don't confuse our 1st quality tubes with seconds & factory rejects.
- If not shipped in 24 hrs. your order free!
- Free! New catalog write today!

CORNELL
ELECTRONICS DEPT. EW-1
4217 University Ave.
San Diego, Calif. 92105

ELECTRONICS WORLD JANUARY 1970

ADVERTISERS INDEX

READER SERVICE NO.	ADVERTISER	PAGE NO.	READER SERVICE NO.	ADVERTISER	PAGE NO.
150	Allied Radio	51, 52	124	Lafayette Radio Electronics	94
149	Arcturus Electronics	97		Lampkin Laboratories	64
148	Automatic Electric	84	123	Liberty Electronics, Inc.	87
147	Bay Products, Inc.	12	122	Mallory, P.R. & Co., Inc.	2
	Bele Electronics Corp.	97	121	Methods Research	85
	Brookstone Co.	91	99	Mosley Electronics, Inc.	84
146	Burstein-Applebee Co.	85	120	Multicore Sales Corp.	64
	CREI, Home Study Division, McGraw- Hill Book Co.	70, 71, 72, 73		National Radio Institute	8, 9, 10, 11
145	Career Academy	91		National Technical Institute	60, 61, 62, 63
144	Chemtronics, Inc.	68	119	Olson Electronics	68
143	Cleveland Institute of Electronics	18, 19, 20, 21	118	Park Electronic Products	99
142	Cook's Institute of Electronics Engineering	89	117	Poly Paks	100
	Cornell Electronics Co.	102		RCA Electronic Components & Devices	FOURTH COVER
141	Crown International	79		RCA Institutes	80, 81, 82, 83
140	Crystek	57		RCA Sales Corp.	22
139	Delta Products, Inc.	54, 55	97	Radar Devices	5
138	Edmund Scientific Co.	101	116	Revox Corporation	86
111	Electro-Voice, Inc.	SECOND COVER	115	Sams, Howard W. & Co., Inc.	95
136	Foredom Electric Co.	59	110	Schober Organ Corp.	69
135	GBC Closed Circuit TV Corp.	88	109	Scott, H.H., Inc.	92
	G & G Radio Supply Co.	100	108	Sencore, Inc.	13
134	General Sales Co.	99	107	Salid State Sales	99
	Goodheart Company, Inc., R.E.	98	106	Sonar Radio Corp.	58
133	Grantham School of Engineering	1	100	Sanar Radio Corp.	58
132	Gregory Electronics Corp.	102		Stereo Center	97
131	Heath Company	76, 77	105	Surplus Center	100
130	IEEE	88		Sylvania Electric	THIRD COVER
129	ICS	65	104	Telex Communications Division	53
128	JFD Electronics Co.	7	137	Tescom Corporation	69
127	Johnson Company, E.F.	17	103	University Sound	93
126	Kenwood Electronics, Inc.	24	98	University Sound	93
125	Kenzac	65		Valparaiso Technical Institute	94
			102	Wolston & Co., Inc.	59
			101	Xcelite, Inc.	4

CLASSIFIED ADVERTISING 98, 99, 100, 101



Our hot ones are the last to go.

The last thing you need is to be called back a day or two after you've replaced the sweep or high voltage tubes in somebody's color TV.

But, they're usually the first to go. Because they get so hot.

So we figured out how to cool them. Now, they last a lot longer.

Take our 6JE6C/6LQ6, for example. It's the horizontal deflection tube that takes such a beating when the set gets hot.

Well, we've given it special patented radiator fins that first absorb the heat and then radiate it out of the tube.

Now it runs cooler and lasts longer. Same for our 6JS6C.

Or take our 6BK4C/6EL4A. That's the shunt regulator that eliminates runaway high voltage. We gave this one a whole new anode and shield design to improve heat transfer and stability.

Now it also runs cooler and lasts longer.

Or take our 3A3B high voltage rectifier. This one's got leaded glass for added protection. And it lasts longer too.

So next time you have to replace any of the hot ones, just cool it. You'll both last longer.

SYLVANIA
GENERAL TELEPHONE & ELECTRONICS

Why do you protect your service reputation each time you install an RCA color picture tube?



Whether it's in the customer's living room, or at the bench in the shop, it helps to be able to replace a color picture tube with confidence.

If it's an RCA tube that's being installed, the tube itself can contribute to that confidence.

Here is a product made with know-how...from the most experienced manufacturer in the business. A tube unstintingly manufactured to the highest quality standards... RCA standards. A color picture tube whose built-in technology helps protect your time and talent.

Why not specify RCA picture tubes for your requirements? They'll help protect your service reputation. Just as they're designed to protect the biggest reputation in the COLOR TV industry.

RCA Electronic Components, Harrison, N.J.

RCA